

NAVAL POSTGRADUATE SCHOOL RESEARCH

Volume 10, Number 2

June 2000

DEVELOPMENT OF THE RAPID FLIGHT TEST PROTOTYPING SYSTEM FOR UNMANNED AIR VEHICLES

Associate Professor Isaac I. Kaminer

Department of Aeronautics and Astronautics

Introduction

The past two decades have witnessed a dramatic increase in the utilization of Unmanned Air Vehicles (UAVs) by the armed forces, both in the U.S. and abroad. More recently, many researchers in the academic community have realized the usefulness of UAVs both as teaching and research tools. To develop UAVs and their flight control systems, a number of engineering problems must be addressed covering a wide range of issues that include weight and energy restrictions, portability, risk factors, electronic interferences, vibrations and manpower. Furthermore, the testing of new algorithms, sensor packages, and vehicles is a truly multi-disciplinary effort that borrows from many branches of the engineering sciences that include aeronautical, electrical, and computer engineering. The process is costly and time consuming, and has the potential for catastrophic failure. When successfully completed, however, it provides developmental information, insight, and field data that cannot be obtained from other sources. Thus the importance to develop systems to enable rapid flight testing of new theoretical/practical concepts.

Motivated by these considerations and as a contribution towards the development of a versatile set-up for advanced UAV system design and testing, the Naval Postgraduate School has recently completed development of a Rapid Flight Test Prototyping System (RFTPS) for a prototype UAV named Frog. This article describes the complete RFTPS system that utilizes the Frog UAV and a portable ground station, and explains how it is being used as a rapid proof-of-concept tool for testing new control algorithms for unmanned air vehicles.

System Description

The Rapid Flight Test Prototyping System consists of a test bed unmanned air vehicle equipped with an avionics suite necessary for autonomous flight, and a ground station responsible for flight control of the UAV and flight data collection, as shown in Figures 1 and 2, respectively. A functional block diagram of the RFTPS is shown in Figure 3. The key decision when designing the RFTPS was to use off-the-shelf technology as much as possible, thus exploiting the economy of scale of a number of commercial industries. Furthermore, since the UAV development program is to span many years and to draw on the talents of NPS students in the future, the RFTPS emphasizes high-level algorithm development. Low-level code and device driver generation is therefore kept to a minimum; the vast majority of the code "writing" being done via autocode tools. The system architecture is open, providing the ability to add, remove, or change real time input/output (I/O). Computational power can be increased as mission requirements dictate. The telemetry

--continued on page 2

IN THIS ISSUE

<i>Featured Projects</i>	1, 4
<i>Research and Education</i>	6
<i>Research Labs</i>	10
<i>Research Centers</i>	12
<i>Project Notes</i>	14
<i>Student Research</i>	22
<i>Partnerships</i>	25
<i>Tenant Relationship</i>	28
<i>Research Chairs</i>	30
<i>Conferences/Short Courses</i>	32
<i>Technology Transfer</i>	35
<i>Faculty News</i>	36
<i>Conference Calendar</i>	51
<i>Directories</i>	52

NPS RESEARCH

is published by the Office of the Dean of Research in accordance with NAVSO P-35. Views and opinions expressed are not necessarily those of the Department of the Navy. Comments/inquiries can be addressed via email to research@nps.navy.mil.



NAVAL POSTGRADUATE SCHOOL, MONTEREY, CA

Superintendent

RADM Richard H. Wells, USNR

Provost

Dr. Richard Elster

Associate Provost and

Dean of Research

Dr. David W. Netzer

FEATURED PROJECT

RAPID FLIGHT TEST PROTOTYPING SYSTEM, *continued from page 1*

links are secure, yet low power and unobtrusive to the public, thus dispensing with the need for special authorizations from government authorities. The onboard components are lightweight and low power, allowing for the inclusion of additional payload.

Rapid Flight Test Prototyping System Capabilities

The RFTPS developed provides the following capabilities. 1) Within the RFTPS environment, one can synthesize, analyze and simulate guidance, navigation, control, and mission management algorithms using a high level development language. 2) Algorithms are seamlessly moved from the high level design and simulation environment to the real time processor. 3) The RFTPS utilizes industry standard I/O including digital-to-analog, analog-to-digital, serial, and pulse width modulation capabilities. 4) The RFTPS is portable, easily fitting in a car. In general, testing will occur at fields away from the immediate vicinity of the Naval Postgraduate School. 5) The unmanned air vehicle can be flown manually, autonomously, or using a combination of the two. 6) All input/output and internal algorithm variables can be monitored, collected, and analyzed within the RFTPS environment.

Cost and risk were two leading, and, at times, competing concerns which had to be effectively handled. Since all initial testing of new algorithms or vehicle systems is expected to occur within line-of-sight at all times, a pulse width modulated (PWM) remote control system manufactured by Futaba was chosen. Testing of a new control algorithm is similar to handing over control of the aircraft to a student pilot. The algorithm should have full freedom to perform, yet adequate safeguards must exist in case it fails. With some modifications, the extensive master-slave flight training capabilities built in to the existing RC transmitters were exploited. A

--continued on page 3



Figure 1. (top) The unmanned air vehicle Frog at the Naval Postgraduate School. Figure 2. (left) The base station of the RFTPS in use at the airfield. Figure 3. (below) RFTPS Hardware Architecture

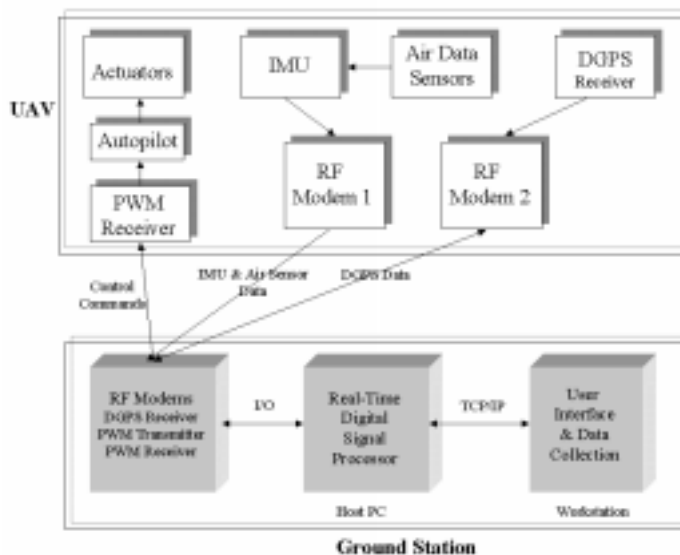

FEATURED PROJECT

RAPID FLIGHT TEST PROTOTYPING SYSTEM, *continued from page 2*

significant portion of the cost of the RFTPS resides in the real time processor, I/O board and modules, and in the host computer. In spite of their compactness, the weight and power requirements of these components are significant when compared to onboard power and payload available. In order to gain additional payload and manage the risk associated with the loss of an expensive computer package, the real time controller was kept on the ground. Sensor and control links to the real time controller were bridged via a spread spectrum RF link.

The centerpiece of the RFTPS ground station is the AC100/C30 System from Integrated Systems Incorporated. The key feature of this product is its autocode tools. With a relatively short time available for research by the NPS students, emphasis had to be shifted from code writing, debugging, and maintenance to algorithm development. The AC100/C30 utilizes "Xmath/SystemBuild," a graphical programming environment that uses a high-level block diagram paradigm for modeling of linear and nonlinear systems. Within the "Xmath/SystemBuild" environment, algorithms can be built, simulated, tested, and debugged. Real-time code can then be generated for execution on the real time processor.

Consider Figure 3. The "Xmath/SystemBuild" software package resides on a Sun Workstation. Communication with the real time processor is via an Ethernet bus using TCP/IP

protocol and is managed by the host PC. The AC100/C30 provides extensive animation tools for building graphical user interfaces (GUI). By appropriate design of these interfaces, the flight test team can monitor, modify, and control the actions of the real time processor. The GUI resides on the workstation. Additionally, the host PC provides power to the real time processor, as well as utilities for compiling, linking, and downloading the C-code. The I/O consists of four multi-mode, bi-directional serial ports utilizing RS-232 protocol, a 16-channel pulse width modulation (PWM) port capable of measuring up to sixteen PWM signals or generating up to six PWM signals, and a six channel digital-to-analog converter. The I/O modules are hosted by the same PC that holds the real time processor, a single Texas Instruments Digital Signal Processor (TMS320C30).

Trajectory Control: An Application of the Rapid Flight Test Prototyping System

This section illustrates the utility of the RFTPS system by illustrating how it was used to successfully flight test a new trajectory tracking algorithm for autonomous vehicles [1]. This project was chosen because of the complexity of the algorithm adopted, and because its implementation requires going through all the steps that are normally required of any application involving autonomous flight of air vehicles.

--continued on page 40

About the INVESTIGATOR

Isaac I. Kaminer is an Associate Professor in the Department of Aeronautics and Astronautics. He received his undergraduate degree and Master of Science from the University of Minnesota followed by his Ph.D. in Electrical Engineering Systems from the University of Michigan. Before joining NPS he served as a research consultant on the MARIUS Underwater Vehicle Project at the Technical University of Lisbon, and as a Research Engineer with Boeing Commercial Airplanes Company.

Dr. Kaminer serves as a reviewer on several American and International scientific journals including the *IEEE Transactions on Automatic Control*, *IEEE Transactions on Control Technology*, the *IFAC Automatica*, *AIAA Journal of Guidance, Control and Dynamics*, the *International Journal of Nonlinear and Robust Control*, and *Mathematics of Control, Signals and Systems*. His research and teaching interests include air vehicles, modeling and simulation, flight controls, and

conventional weapons.

Dr. Kaminer is the 1999 recipient of the Carl E. and Jessie W. Menneken Annual Faculty Award for Excellence in Scientific Research. This award recognizes recent highly meritorious research having identifiable impact on Navy or DoD technology and is intended especially for the encouragement and benefit of younger faculty members.



Isaac I. Kaminer

FEATURED PROJECT

THE PLANNER'S DILEMMA: INNOVATION, TECHNOLOGICAL CHANGE, AND LONG-RANGE PLANNING

Office of Naval Research/Naval Postgraduate School/Chief of Naval Operations Executive Panel (ONR/NPS/CEP)

Innovation in Naval Warfare Systems Studies 1997-1999

Research Professor Michael Melich

Institute for Joint Warfare Analysis

Research Professor (emeritus) Patrick Parker

CAPT Edward A. Smith, Jr., USN (Ret.)

Although program planning and resource allocation in the DoD is largely focused on the midrange, i.e. 3 to 10 years, Navy leaders have recognized the importance of long range planning. When the service life of ships and aircraft are numbered in decades and the development and production of a major system takes 15 years or more, it is certainly necessary to take into account both the distant threat environment and the new technologies that might come into play years hence. During the Cold War, the difficulty of making such long-term projections was eased by an ability to focus on a single agreed adversary, the Soviet Union. They were also aided by the Soviet reliance on a stepped, highly bureaucratic acquisition process that made technological advances and their integration into the armed forces discernible well in advance. With the end of the Cold War, this focus and predictability disappeared. Increasingly, civilian not military technology was on the cutting edge particularly in information systems. Moreover, the new technologies were widely exported with

militaries adapting "off-the-shelf" systems to their needs. The predictability of Soviet defense planning was replaced by uncertainty. Long range planning efforts in the U.S. and abroad faced a common problem. What might a future threat environment contain and how might it be shaped by emerging technologies?

Over the years the Office of Naval Research, the Naval War College, the CNO Executive Panel (CEP), and the Strategic Studies Group have all been instrumental in helping top management keep a watchful eye on the future. Modern naval history dramatizes the importance of technical change in revolutionizing the nature of naval warfare. The introduction of steam in the 19th century, and aviation and radio in the first half of the 20th are useful examples. A navy that failed to recognize their importance, undertake the necessary engineering developments, and develop the organizations and operational art to exploit them simply ceased to be a player.

In recent years the Innovation Task Force of the CEP, headed by Walt Morrow and Ben Huberman has served as a spark plug for a number of CNO actions to see that the Navy is alert to the implications of advances in science and

--continued on page 5

About the INVESTIGATORS

Michael E. Melich is a Research Professor in the Institute for Joint Warfare Analysis. He received his B.S. degree in Physics from Stanford University, his M.S. in experimental physics from the University of Utah and an M.A. and Ph.D. in theoretical physics from Rice University. He joined the faculty at NPS in 1985 as the Naval Sea Systems Command Chair in Combat Systems as a member of the Operations Research Department. He has been a member of the Physics Department and the Space Systems Academic Group where his interests in the use of combat systems and space systems have been pursued. Prior to joining the NPS faculty he was head of the Navy Command and Control System Lead Laboratory at the Naval Research Laboratory. Upon completion of his Ph.D. he joined the Operations Evaluation Group of the Center for Naval Analysis where he lead the air defense analysis team and established the Command and Control Group concerned with the use of national surveillance systems in tactical operations. He

served as the Operations Analyst for the Commander of the First Fleet and co-authored a Naval Institute Proceedings June 1976 article with

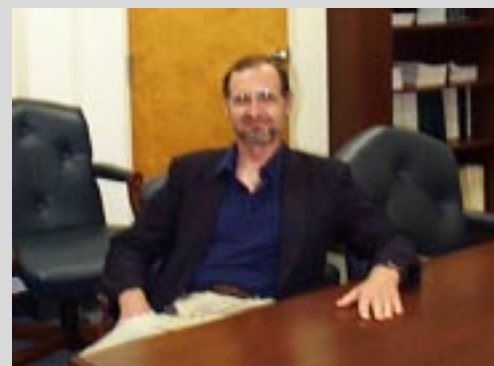

Michael E. Melich

the Commander entitled "Fleet Commanders: Afloat or Ashore?" which foreshadowed the debates on the use of space in military operations. He served on the Lethal Systems Panel of the National Academy of Sciences/ National Research Council for the US Army on Strategic Technologies for the Army of the Twenty-First Century.

--continued on page 5

FEATURED PROJECT

THE PLANNER'S DILEMMA, *continued from page 4*

technology. A keen awareness of the accelerating pace of scientific discovery and complexity has added a sense of urgency. The accelerating pace of change confronts the Navy with a worsening dilemma: the Navy is capital intensive; modern warships are generally large and expensive, take a long time to build, and last a long time. Creating a fleet that is effective today and is at the same time designed with the flexibility to incorporate several generations of technical change over its lengthy service life is a constant and extremely difficult challenge.

One Navy initiative was to redirect the CNO's Strategic Studies Group (SSG). The SSG is a group of about eight, high performing O-6s assigned for a year to think about fundamental issues facing the U.S. Naval Service in the future. The leadership and agenda of the SSG had previously emphasized Political/Military matters. The new direction and leadership emphasized technical change and innovation. The new leadership, Admiral James Hogg, USN (Ret.), had a formidable record of technological innovation and broad operational fleet experience. The new SSG's direction emphasized the importance of the accelerating pace of technology. The purpose was to identify technology drivers and conceive of ways in which they might create opportunities for the Naval Service to remain preeminent over the next 25-30 years. Admiral Hogg was directed to use the Naval Postgraduate

School's scientific and engineering resources for support. NPS organized three-day technology seminars where leaders in science and engineering presented the state-of-the-art and made speculative projections in fields as diverse as biomolecular engineering, the revolution in designing materials, the increasing demand for "system engineering," the development trajectory and scientific limitations on the semiconductor based information revolution, etc. At the first seminar in December 1995, Dr. Fred Saalfeld, Technical Director of the Office of Naval Research, initiated a study, to support the SSG's innovation efforts and involve the faculty and officer students of the NPS. From Dr. Saalfeld's initiative was born a three-year ONR/NPS program of research and study whose tasking was generated by the CNO Executive Panel, N00K, with CAPT Edward Smith as the study liaison, coordinator and intellectual leader. The 1998 and 1999 study task was to explore the ability of potential competitors to blunt USN strike force effectiveness by developing and deploying systems to keep U.S. strike forces beyond about 600 NM, the effective reach of their weapons.

Area Denial (Red Teaming): The Approach

Prior to our ONR/NPS/CEP study there had been a flurry of Navy activity associated with the Revolution in Military

--continued on page 41

INVESTIGATORS, *continued from page 4*



Patrick J. Parker

ers and Intelligence (C4I) Academic Group. He has also served as Chairman of the Department of National Security Affairs. He chaired the CNO Executive Panel at its inception and served as a member of that group for fourteen years. Prior to coming to NPS, Professor Parker served as Deputy Assistant Secretary of Defense for Intelligence and

Patrick J. Parker, now emeritus, was a Research Professor of Applied Systems Analysis in the Command, Control, Communications, Comput-

Director of Tactical Air Programs in OSD(SA). He has served as Associate Dean of the Graduate School of Business at the University of Rochester and President and CEO of the Hickok Manufacturing Company. He is currently President and CEO of the AEQUUS Institute, a charitable trust. Mr. Parker's research interests include strategic planning and perceptions management. He is co-author of the book *Soviet Strategic Deception*.

Edward A. Smith, Jr. retired from the Navy and the CNO Executive Panel staff in 1998. He was a primary player in creating the Navy's *...From the Sea* and its subsequent amplification in *Forward...From the Sea* and the CNO's *Anytime, Anywhere* vision. He has written numerous articles and contributed a chapter to a recent book *Strategic Adjustment* (Columbia U. Press, 1999). He currently works as a senior defense analyst for Boeing and continues a close interaction with Navy innovation efforts in both Monterey and Newport. He holds a Ph.D. in International Relations from The American University.

RESEARCH AND EDUCATION

OPERATIONS RESEARCH CURRICULA PRODUCE DECISION-MAKERS

Two curricula, Operations Analysis and Operational Logistics, lead to the degree Master of Science in Operations Research (OR). Taught in the Department of Operations Research at the Naval Postgraduate School, both curricula emphasize the use of mathematical modeling, simulation and analysis to help people make better decisions. Both include a six-week experience tour where students typically visit an operational command to test their skills on real problems. The experience tour is the real-world laboratory for the curricula and is usually the client for the thesis research subsequently performed by the student.

The Operations Analysis (OA) Curriculum was established by the Navy in 1951 when it recognized that the OR concepts and techniques pioneered in WWII were worth preserving. OA is the development and application of mathematical models, statistical analyses, simulations, analytical reasoning and common sense to the improvement of real-world operations. Practitioners are called upon to advise military and civilian decision-makers on the allocation of scarce resources, the selection of new equipment and processes, and the optimal deployment of given resources to achieve required missions.

Mathematics, probability, statistics, economics, human factors, and optimization supply the theoretical background for analyzing alternative choices in tactical and strategic

warfare, and in planning, budgeting and acquisition of systems and forces. The student learns computational methods and develops skills to identify relevant information, formulate decision criteria and select alternatives. The Navy sponsor for the OA curriculum is the Office of Chief of Naval Operations, Assessment Division (N81).

The Operational Logistics (OL) Curriculum was initiated in 1986 by the Deputy Chief of Naval Operations (Logistics) and supports the Operational Logistics subspecialty (xx43). There are subspecialty billets in the Joint Chiefs of Staff, OPNAV, Fleet CINCs, and afloat staffs. Students have included officers of the Navy, Marine Corps, and Army. Navy students have included all warfare specialties, fleet support, and staff corps.

The OL curriculum is strongly related to the OA curriculum and shares course work in mathematics, probability and statistics, computing and simulation, optimization, and warfare modeling and analysis. The focus on operational logistics is created through unique courses on naval and joint logistics, defense transportation systems, logistics models, and special operational logistics seminars.

The education provided in the Operations Analysis and Operational Logistics programs enhances performance in all duties throughout a military career including operational

--continued on page 7

MILITARY OPERATIONS RESEARCH SOCIETY AWARD

LT Gregory Chapman, USN (June 2000) has just won the Stephen A. Tisdale Award of the Military Operations Research Society for best Masters thesis in Operations Research (OR) at NPS. His thesis optimizes the inventory policy for the Marine Corps Research Institutes (MCIs) course materials. The new policy promises to reduce cost, shortages and warehouse space. LT Chapman was advised by CDR Kevin Maher, SC, USN.

MCI is the distance learning center for the United States Marine Corps. MCI's mission is to develop, publish, distribute, and administer distance training and education materials to enhance, support or develop required skills and knowledge of Marines. It also satisfies other training and education requirements as identified by the Commanding General, Marine Corps Combat Development Command.

To meet this mission, MCI develops and assembles course materials ranging from simple training courses to college-level Professional Military Education (PME) programs. Each course or program consists of multiple components that must be printed, stocked, and distributed to all Marines. Currently MCI offers 151 courses comprising 305 printed components; in 1999, MCI

processed over half a million requests for course materials.

Early last year, MCI recognized the need to improve their inventory control processes and services levels by optimizing reorder points and reorder quantities for course materials. LT Chapman spent five weeks with MCI and went on to develop an inventory model — a non-linear program — to set those reorder points and quantities and thereby minimize shortages. Shortages are incurred for orders that cannot be filled immediately, and MCI had too many.

Inventory theory is an active area of study within OR, and LT Chapman's thesis is based on and extends this theory. Results from the thesis indicate that shortages can be reduced from about 10,000 per year to a few hundred, and that warehouse space can be reduced 30%-50%. The Marine Corps is implementing the model, and its advice, immediately.

LT Chapman began the Operational Logistics curriculum, in the OR Department at the Naval Postgraduate School, in June 1998. His next assignment returns him to Newport, Rhode Island, for Surface Warfare Officer School, Department Head Course, commencing July 2000.

RESEARCH AND EDUCATION

OPERATIONS RESEARCH CURRICULA, *continued from page 6*

billets, technical management assignments, and policy-making positions. As with all NPS curricula, OR blends education and research to produce a synergy between students, faculty and sponsors. Highlighted below are a few samples of this synergy at work.

Distributing Intra-Theater Wartime POL Requirements

The Commander-in-Chief, United States Pacific Command (USCINCPAC) must ensure sufficient storage and distribution assets are available to satisfy wartime petroleum, oil, and lubrication (POL) requirements in the Pacific Theater. Prior to the thesis of **LCDR Tracy Keenan, SC, USN** (September 1999), USCINCPAC did not have a model to determine if planned re-supply and intra-theater transportation assets (pipelines, railcars, tank trucks and tankers) could satisfy wartime POL requirements. Solving USCINCPAC's worst-case scenario for U.S. forces in Japan (spanning 120 days and total POL requirements of 26 million barrels), her model shows that requirements cannot be satisfied with existing infrastructure and transportation assets. But, her analyses also show ways to eliminate these shortfalls. Operations Research Associate Professor **Robert Dell**, LCDR Keenan's thesis advisor, has continued to use her model to help USCINCPAC plan infrastructure improvements.

Earlier this year, the USCINCPAC Director for Logistics, Brigadier General Philip Mattox, USA, wrote to the NPS Superintendent saying, "My staff and I are extremely impressed with LCDR Keenan's thesis entitled 'Distributing Intra-theater Wartime POL Requirements.' LCDR Keenan's dedication in researching this issue is very much appreciated and worthy of recognition."

A Decision Support System for Sea-Based Sustainment Operations

Building a sea-based logistics decision-support system (DSS) for MEU-sized operations was the thrust of the thesis of **Capt Norman Reitter, USMC** (September 1999). The DSS was built to facilitate the collaborative mission planning and dialogue between operators and logisticians. The need for such capabilities has been noted in other studies. This issue has been of continuing interest to Distinguished Professor **David A. Schrady**, who was Capt Reitter's advisor. The principal entities modeled in the DSS are forces and transport aircraft. In the setup phase, the force required for a given mission is modeled by selecting from a menu of combat, combat support, and combat service support force components. The combat forces range from an infantry fireteam to

--continued on page 8

UNITED STATES ARMY CHIEF OF STAFF AWARD

MAJ Wade S. Yamada, USA (June 2000) has been awarded the United States Army Chief of Staff Annual Award for Excellence in Operations Research. He won the award for his thesis research that developed manpower planning models to forecast Army officer inventory. His thesis advisor was Associate Professor **Siriphong Lawphongpanich** in the Department of Operations Research.

Within the Military Strength and Forecasting Division, Office of the Deputy Chief of Staff for Personnel (ODCSPER), United States Army, military analysts utilize various tools/decision aids to forecast Army officer inventory. Current tools/decision aids are implemented in a spreadsheet and lack a component that optimizes various management controls for shaping or regulating the officer inventory. These controls include accession, promotion, and, when necessary, separation, typically via some early retirement programs. Past attempts to develop optimization models to aid in the forecasting and management of the officer inventory were not successful. These models recommended unfamiliar management decisions and required too much time to obtain a solution. In one case, the model must be executed overnight on a mainframe

computer.

MAJ Yamada's thesis develops an optimization model that addresses the officer inventory at a more aggregate level and requires considerably less time (less than a few minutes) to solve. The main goal with the proposed model is to permit analysts the ability to perform what-if analysis quickly and to enhance its usability by allowing the model to be implemented or interfaced with a spreadsheet.

In theory, the planning horizon for most manpower planning models is infinite. However, the horizon is often truncated to a much shorter interval, e.g., between 5 and 30 years, in practice. Doing so produces errors known as end effects. The thesis uses techniques known in the literature as primal and dual equilibrium in combination with a new sampling scheme to reduce end effects as well as the size of the resulting model. Historical data are used to illustrate the models applications under scenarios suggested by ODCSPER analysts.

Upon graduation, MAJ Yamada will be assigned to the Military Strength Analysis and Forecasting Division, Office of the Deputy Chief of Staff for Personnel (ODCSPER), to serve as an officer personnel analyst.

RESEARCH AND EDUCATION

OPERATIONS RESEARCH CURRICULA, *continued from page 7*

an infantry battalion. Combat support forces include an artillery battery, LAV detachment, AAV detachment, tank platoon, combat engineering detachment, and some combat service support units. Each force component has its associated logistics planning factors for rations, water, fuel, and ammunition. When the force is identified, its logistic support requirements are automatically aggregated. The next part of the DSS is the set of events in which the force participates over time. While rations and water are consumed daily independent of the activities or events of the force, the use of fuel and ammunition depends on events. The force events are movement to objective, assault, defense, etc. The force events are the means for reflecting the commanders concept of operations. Aircraft events include resupply, troop movement, and MEDEVAC. In recognition of the competition between operations and logistics for air assets discovered earlier, the DSS has an automated transport aircraft scheduler.

Since the number of MV-22 and CH-53E aircraft available in an amphibious readiness group is finite, Capt Reitter modeled each aircraft individually in terms of its accumulated flight hours, hours until its next maintenance action, and crew hours on a given day. His scheduler assigns available aircraft based upon lift requirements, distances, and other information. Multi-task sorties can be scheduled; i.e., transport fuel from the sea base to site A, move troops from

site A to site B, and return to the sea base with casualties from site B. Infeasibilities, for example the requirement for more sorties in a given period of time than the available aircraft can generate, can be found during planning performed within the DSS and this allows the plan to be modified accordingly.

Large Scale Network Algorithms

LT Matt Gibbons, USN (June 2000) advised by Professor Kevin Wood, is developing and implementing an algorithm for network analysis in a project sponsored by the National Security Agency (NSA). A "minimum-capacity cutset" in a network can represent the optimal set of links (or nodes) in that network to intercept (eavesdrop on) or cut (interdict) all communications traveling between, say, a central military commander and a distant field commander. Secondary criteria, e.g., safety of interceptors, collateral damage, etc., can make strictly optimal solutions undesirable, however. One approach to dealing with this problem is to enumerate a large set of "near-minimum cutsets," and filter those against the secondary criteria. This enumeration is the focus of the new algorithm.

A lot of supercomputer time has been spent, in a brute force manner, enumerating all cutsets in networks. This may be useful for some problems, but is hopeless for normal road and communications networks because the number of cutsets increases exponentially with the size of such networks. Another approach to the problem is to enumerate all minimum (-capacity) cutsets: NSA already has efficient computer codes to solve this problem. But, the set of minimum cutsets may not be rich enough to allow for much flexibility with respect to the secondary criteria. NSA wants to look at near-minimum cutsets, efficiently.

The algorithm being developed is based on a tree-enumeration that includes and excludes certain arcs from the next potential near-minimum cutset. Special backtracking rules limit the amount of enumeration needed: Some rules are simple, e.g., backtrack if the total included capacity exceeds the total allowed, and some are more complicated, e.g., backtrack if the implied values of dual variables (from linear-programming duality theory) are contradictory. The algorithm is coded in Java and is already

--continued on page 9

INFORMS AWARD FOR THE TEACHING OF OPERATIONS RESEARCH/MANAGEMENT SCIENCE (OR/MS) PRACTICE

The Institute for Operations Research and Management Science (INFORMS) presents the INFORMS Prize for Teaching of OR/MS Practice annually to a university or college teacher who excels in teaching the practice of OR/MS. This purpose of this award is to recognize a teacher who has succeeded in helping his/her students to acquire the knowledge and skills necessary to be effective practitioners of operations research, or the management sciences.

Professor Richard Rosenthal is the 2000 recipient of this prestigious award. Dr. Rosenthal has taught hundreds of students at NPS and the University of Tennessee. He is a dynamic, effective and inspiring teacher and mentor, and many of his former students find their lives and careers transformed by the lessons he taught them.

Currently Chair of the Operations Research Department, Dr. Rosenthal leads a department that emphasizes the practical aspects of operations research. As a new faculty member at NPS several years ago, he introduced algebraic modeling languages into the teaching of optimization and developed teaching materials transforming optimization-based decision support systems into a popular topic for students. His teaching has always emphasized the practical aspects of OR/MS and he has supervised many applied thesis projects.

RESEARCH AND EDUCATION

OPERATIONS RESEARCH CURRICULA, *continued from page 8*

solving problems with thousands of links and nodes in a few minutes on a personal computer.

Optimally Scheduling EA-6B Depot Maintenance

A current research project of Associate Professor **Robert F. Dell** is to equip the EA-6B Program Office with a desktop, optimization-based decision-support tool to schedule all depot maintenance (standard depot level maintenance, wing center section replacements, and major aircraft modifications) for the EA-6B Prowler fleet. This effort grew from the thesis of **LCDR Bradley Meeks, USN** (September 1999) advised by Professor Dell. **MAJ Ross Baker, USMC** (September 2000) is aiding Professor Dell with final development.

Ranging from Operation Desert Storm to combat actions in the Balkans, EA-6B Prowler aircraft lie at the heart of nearly all tactical aircraft strikes. Providing a fleet capable of such combat actions in the next decade challenges the Prowler community to efficiently schedule EA-6B depot maintenance services. By 2009, EA-6B depots must conduct 80 wing center section replacements, 144 major aircraft modifications and 154 instances of standard depot-level maintenance. There are several complex rules governing when each Prowler is eligible for each service; these rules are also flexible enough to allow more induction schedules than can be evaluated manually in a reasonable amount of time. Because each service removes aircraft from mission inventory for six to 12 months, and performing multiple services together requires less time than performing services independently, services should be combined whenever possible.

LCDR Meek's thesis develops a mixed-integer linear program prototype, EA-6B Depot Maintenance Optimization Model (EDMOM), to help schedule EA-6B aircraft for depot maintenance services. EDMOM minimizes total time aircraft are removed from mission inventory; it produces an induction schedule for the

EA-6B fleet through 2009 that adheres to all appropriate rules and conducts 378 services in only 216 inductions, requiring 2,446 total months. Without combining services, it would require 3,630 months, nearly 50 percent longer.

Visual Perception Issues Pertaining to Military Systems

The Office of Naval Research, Naval Research Laboratory, TENCAP, and Lockheed Martin Corporation currently fund Assistant Professor **William Kreb's** Perception Laboratory to investigate visual perception issues pertaining to military systems. Student and faculty research projects are ongoing in the lab.

LCDR Tom Evanoff, USN (December 1999) was bestowed the Military Operations Research Society Award for his thesis, "Design and Analysis of a Shipboard Visual Navigation Aid

--continued on page 43



Figure 1. The Tactical Vectoring Equipment (TVE) shipboard navigation display resulted from the thesis work of LCDR Evanoff to design and analyze a shipboard visual navigation aid for vessels in formation. The TVE display contains a horizontal line of its bicolor (red and white) lights spaced approximately six feet apart on the stern of the carrier.

RESEARCH LAB

RADAR AND ELECTRONIC WARFARE SYSTEMS LABORATORY

Professor Jeffrey Knorr
Professor Clark Robertson
Associate Professor David Jenn
Associate Professor Phillip Pace
Research Associate Professor Lonnie Wilson
Visiting Associate Professor Ron Pieper
Mr. Paul Buczynski
Department of Electrical and Computer Engineering
Professor D. Curtis Schleher, Information Warfare Academic Group

Introduction

The objective of the Radar and Electronic Warfare (EW) Systems Laboratory is to educate military officer and civilians in the technology and operational characteristics of electronic warfare. The Laboratory is sponsored in part by:

- Tactical Electronic Warfare Division, Naval Research Laboratory
- Air Force Information Warfare Center
- Air Force Research Laboratory
- Electronic Warfare Advanced Technology Group, NAVAIR

The Radar and Electronic Warfare Systems Laboratory supports both research and instruction and is divided into two sections: the Hardware Laboratory and the Computer Processing Laboratory. Maintaining a hardware laboratory where the students can make measurements on instrumented equipment used in the field, is extremely important in radar, infrared and electronic warfare (EW) education. That is, the hardware laboratory lends itself to a hands-on approach. To extend the educational learning experience to more advanced situations (for example an anti-ship cruise missile approaching a ship), computer laboratories are also maintained with a variety of specialized software dedicated to analyzing the effectiveness of defense systems. These laboratories are described below and allow the student to explore and analyze all facets of EW.

Hardware Laboratory

The hardware laboratory contains instrumented radar and electronic warfare equipment and has been in operation for over 35 years. The laboratory location on NPS is easy to spot. Just look for the building with all of the antennas on top

(Spanagel Hall). Each radar system is well instrumented to operate as a teaching tool. The equipment allows the student to experience hands-on knowledge of performance characteristics, conduct experimental research and reinforces concepts that are taught in the classroom. The radar and electronic warfare hardware within the lab is briefly described below.

Radar Systems

- AN/SPS-10B - C-Band, Surface Search and Navigation Radar; Vacuum tube conventional pulse magnetron transmitter with linear receiver
- AN/SPS-12C - L-Band, Air Search Radar; Vacuum tube conventional pulse magnetron transmitter with parametric amplifier, lin/log receiver
- AN/SPS-40C - UHF Master Oscillator Power Amplifier Long Range Digital MTI, Pulse Compression, Air Search Radar; Linear FM Chirp (Pulse Expansion/Compression)
- AN/SPS-58A - L-Band, Master Oscillator Power Amplifier, Point Defense MTI Radar; Solid state, stalo/coho, coherent klystron transmitter; IF and phase detection, analog-to-digital, with arithmetic processing receiver
- AN/SPS-64(V)9 - X-Band, Surface Search and Navigation Radar; Solid state, pulsed magnetron transmitter; Solid state, TTL, logarithmic receiver; End-Fed slotted Array Antenna
- AN/SPS-65(V)1 - L-Band, Master Oscillator Power Amplifier, Point Defense MTI Radar; Solid state, stalo/coho, coherent klystron transmitter; IF to I & Q, analog to digital, with I & Q finite impulse response filter processing receiver
- AN/SPS-67(V)1 - C-Band, Surface Search and Navigation Radar; Solid State, coaxial pulse magnetron, jitter PRF transmitter; Solid State, linear/log with various video enhancement in the receiver
- AN/PPS-6 - X-Band, combat surveillance detection of moving terrestrial targets; A non-coherent, pulse doppler with audio output radar system
- AN/UPS-1B - L-Band, medium range, transportable Air Surveillance Radar System; Pulsed magnetron transmitter, coherent on receive MTI receiver
- MK-25 Mod 3 - X-Band, Gun Fire Control tracking Radar; Vacuum tube, coaxial pulse magnetron transmitter with conical scan tracking style antenna and receiver system.

Electronic Warfare Systems

- AN/WLR-1G - 50MHz to 10.7GHz ESM Receiving System with Omni Directional and Spinning DF Antennas;

--continued on page 11

RADAR AND EW LAB, *continued from page 10*

Vacuum tube and solid state 9-Band scanning superhetro-dyne; Pulse width, PRF, direction of arrival display and frequency readout; AM/FM and pulse modes

- WJ-35000 - 2GHz to 6GHz Instantaneous Frequency Measurement (IFM) receiver System; Omni directional, computer controlled, Digital Frequency Discriminator (DFD) processes both CW and pulsed emitters; 100% probability of intercept

- WJ-35100 - 500MHz to 18.0GHz Spinning DF scanning Superhetrodyne Receiver System; Solid state, computer controlled, digital angle spinning DF antenna; Pulse width, PRF, Frequency, Emitter scan time, and angle of arrival, for determining probability of intercept

- AN/DLQ-3 - C/X-Band Active solid state countermeasure system; Techniques - Augmentation, Angle Deception (AM Mode, LORO, Countdown.Blinking), Denial Jam (Spot Noise) and Velocity Deception (Serrodyne/WGWO)

- AN/ULQ-6B - 7GHz to 11 GHz Active solid state ship countermeasure system; Techniques - Decoy Mode, Inverse Gain, Loro, RGPO Mode

- AN/ULQ-21 - 5.55GHz to 11GHz Solid State Active Countermeasure System, part of the AN/ALQ-167; Computer controlled RS-232(C) communication links, 6809 microcontroller/EEPROM memory; Techniques - Continuous Noise (CN), Blinking Noise (BN), Noise and Swept Amplitude Modulation (NSAM), Swept Noise (SWPT), Repeater (REP), Multiple Frequency Repeater (MFR), Repeater and Swept Amplitude Modulation (RSAM), Range Gate Stealer (RGS), Range Gate Stealer and Swept Amplitude Modulation (RGS/SAM), Velocity Gate Stealer (VGS), Narrow Band Repeater Noise (NBRN), Random Doppler (RD), Hold Out and Hook (HO&H), Pseudo Random Noise (PRN), Blinking Pseudo Random Noise (BPRN), Countdown Blinking (CDB) and Fixed Offset (FO)

- CFAX-1 - 8.2GHz to 10GHz Aircraft self protection against the following type of systems: Airborne Interceptor Search Radar (AIS), Airborne Interceptor Conical Scan Radar (AICS), Airborne Interceptor Loro Radar (AIL), and Missile Loro Radars (MIL); Techniques: Inverse Gain (IG), Countdown and Loro (CDL), Loro, Stretched Pulse, Wide Pulse Walk Off (WPWO) and Instantaneous Inverse Gain (IG) with Complementary Function Sinewave (CFS) and Complementary Function Gate (CFG)

- AN/FLQ-2U/SPS-12 - Generic (NPS Built) Denial Jammer to operate against the AN/SPS-12(C). This

jammer is capable of generating spot jamming with the RF carrier FM'd by noise or sinusoidal or triangular function singularly or in combination. In addition, a radar target simulator is used to generate a target in the main lobe as well as random targets in the lobe.

- AN/UST-103/4 - 199MHz to 399MHz Communication/Jammer System; Solid State, Digital Control receiver System with the capability of set-on noise/tone generator jamming system

- High Speed Anti-Radiation Missile (HARM) Block IV - The HARM receiver and processor together are used to angle track sources of radiation which typically come from an acquisition radar that is used to target a surface to air missile (SAM). The HARM missile is carried onboard the EA-6B and used for the suppression of enemy air defense systems.

New Hardware Acquisitions

Recently, the Radar and EW Systems Laboratory has received from the Army, an AN/MPQ-64 known in the radar community as the Sentinel Radar. The system contains the new 2-D phased array technology and has a very high moving target indication improvement factor. This radar will be used for teaching and research and also used on an ongoing effort to support the Center for Interdisciplinary Remotely Piloted Aircraft Studies (CIRPAS) for monitoring the take-off and landing of un-

manned aerial vehicles (UAVs). Since the radar operates in the X-band and is mobile (see

--continued on page 47

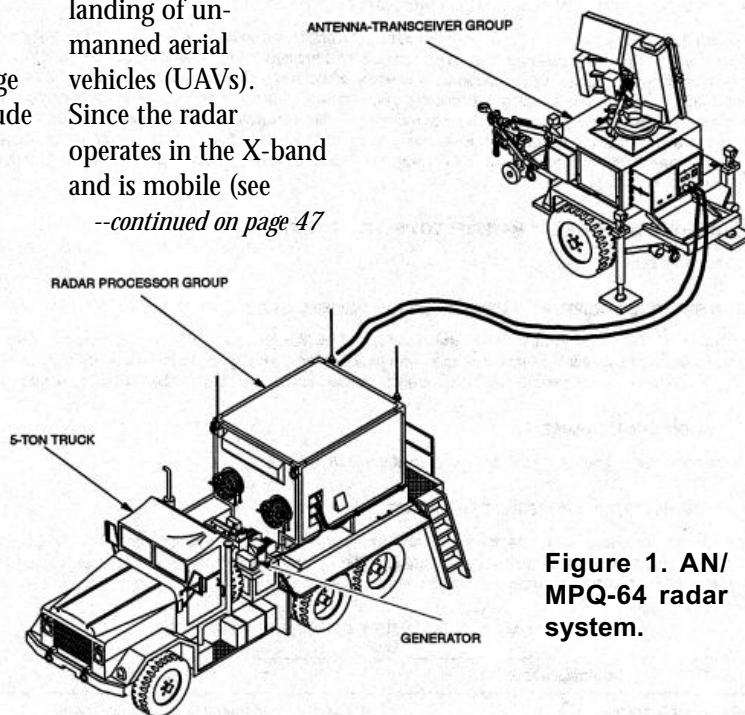

Figure 1. AN/MPQ-64 radar system.

RESEARCH CENTERS

IJWA CONDUCTS THE DATA CAPTURE AND ANALYSIS FOR FLEET BATTLE EXPERIMENT-GOLF

The Institute for Joint Warfare Analysis (IJWA) at the Naval Postgraduate School supported by a team comprised of several Naval Surface Warfare Center (NSWC) Crane Division personnel, four officers from the Surface Warfare Development Group, several Boeing Engineers, and Naval Postgraduate School students and faculty, recently completed the execution of data capture during the execution phase of Fleet Battle Experiment Golf (FBE-G). Fleet Battle Experiment Golf was conducted by Sixth Fleet and the Maritime Battle Center in the Mediterranean. NPS fielded a team of 35 data collectors and coordinators in Italy and the eastern Mediterranean from March 23 until April 20. In addition there was participation by Army, Air Force, Marine and coalition members. Units from Spain, France, Italy, Germany and Israel were also represented.

It was the most successful experiment to date in terms of the amount of data collected in an automated fashion, the use of NSWC Crane personnel as Land Attack Weapons System operators, and the number of personnel actively engaged in observation and data collection. The analysis effort is now underway. The data collection methods developed by Research Assistant Professor **Alex Callahan** and the analysis methods developed by Research Associate Professor **Shelley Gallup** and Research Associate **Rich Kimmel** over the past year and the teamwork effort in data reduction has been the core of the analysis work. The in depth analysis produced by NPS has been the mainstay for the results reported by the Maritime Battle Center and the Fleet Commanders.

The focus for Fleet Battle Experiment Golf was time critical strike and theatre air missile defense (TAMD). The lessons learned from the Kosovo experience were the point of departure for experimentation in this effort. Sensor Management and also Fires Management were key methods for experimentation. In the area of TAMD, different organizational configurations were part of the experimentation effort. The actual play of the exercise extended from April 3 until April 13. The total augmentation force for the experiment was on the order of 450 personnel representing many Navy shore commands and contractor organizations.

--continued on page 13

CENTER FOR AUTONOMOUS UNDERWATER RESEARCH WILL PARTICIPATE IN FLEET BATTLE EXPERIMENT-HOTEL

The Office of Naval Research (ONR), Ocean, Atmosphere and Space Science and Technology Department, will sponsor a field test and demonstration of Unmanned Underwater Vehicle (UUV) technology in application to Naval Mine Countermeasures (MCM) missions June 5-16, at the South

Florida Ocean Measurement Center (SFOMC) near Ft. Lauderdale, FL. These demonstrations are in support of the Organic MCM Future Naval Capability (FNC). A FNC represents a strategic decision by the Navy's Corporate Science and Technology Board to invest a critical mass of funding within a tightly focused area to produce rapid and critical technology developments addressing the highest priority Naval Capability Goals. An important goal of the Organic MCM FNC is to enable forward-deployed

ships to be capable of mine countermeasures, rather than having to rely solely on a dedicated fleet of MCM ships.

The demonstrations will be planned, coordinated and executed by the Naval Sea Systems Command's Naval Surface Warfare Center, Coastal Systems Station (NSWC-CSS), the Navy's leading laboratory in Mine Warfare Research and Development. Participants include the Woods Hole Oceanographic Institution, Lockheed-Martin Corporation, Florida Atlantic University, the Naval Postgraduate School, Benthos Corporation, Foster-Miller Incorporated and NSWC-CSS. The demonstrations will be hosted by the SFOMC near Ft. Lauderdale. SFOMC is a unique consortium of government and academic institutions centered on a densely instrumented, natural in-water laboratory and features continuous, high fidelity environmental measurements from the shoreline out to the 150-meter depth contour. SFOMC is sponsored, in part, by ONR.

These demonstrations include a workup for ONR's participation later this summer in Fleet Battle Experiment-Hotel (FBE-H), during which the technology developers will be exercising realistic MCM mission scenarios with guidance and participation of military personnel from Navy SEAL Teams and the Very Shallow Water MCM Detachment. NPS' Center for Autonomous Underwater Vehicle Research under

--continued on page 13

The Fleet Battle Experiment series is designed to accelerate the maturation and transition of basic research by submitting it to rigorous, real world, operational usage by the Fleet.

RESEARCH CENTERS

NPS CENTER FOR INFOSEC STUDIES AND RESEARCH DESIGNATED CENTER OF ACADEMIC EXCELLENCE IN INFORMATION ASSURANCE EDUCATION

The National Security Agency (NSA) has designated the NPS Center for INFOSEC Studies and Research (CISR) as a Center of Academic Excellence in Information Assurance Education. NPS CISR, under the direction of Assistant Professor **Cynthia Irvine**, joins six other universities across the country to be awarded this distinction for the year 2000. Joining NPS in this distinction are Carnegie Mellon University, Florida State University, National Defense University, Stanford University, University of Illinois at Urbana-Champaign, and the University of Tulsa.

An award ceremony was held on 24 May 2000 at the Fourth National Colloquium for Information Systems Security Education. Certificates were signed by Lt. General

Michael V. Hayden, Director, National Security Agency and Mr. Michael Jacobs, Deputy Director, National Security Agency. Mr. Jacobs made the presentation. A reception to honor the thirteen Centers of Excellence was held by the White House in the Old Executive Office Building on 25 May.

Designations were granted following a rigorous review of university applications against established criteria that measure the depth and maturity of information assurance programs, and are rooted in National Security Telecommunications and Information Systems Security Committee (NSTISSC) Training Standards. The NSTISSC is an inter-governmental organization that sets standards for systems security.

Centers of Academic Excellence in Information Assurance (IA) Education is an outreach program designed and operated by the National Security Agency (NSA) in the spirit of Presidential Decision Directive 63 (PDD 63), the Clinton Administration's Policy on Critical Infrastructure Protection, May 1998. The program goal is to reduce vulnerabilities in our National Information Infrastructure by promoting higher education in information assurance, and producing a growing number of professionals with IA expertise in various disciplines. *Additional information on CISR can be found at <http://cizr.nps.navy.mil>.*

The National Security Telecommunications and Information Systems Security Committee (NSTISSC) and the National Security Agency has certified that the NPS curricula developed by CISR is compliant for academic years 2000 through 2003. The curriculum mapped to the NSTISSC's Standards for Information Systems Security Professionals. Determination of compliance was made by national-level subject matter experts in information assurance (IA). The certificate was awarded in March 2000 by Mr. Arthur L. Money, Chairman, National Security Telecommunications and Information Assurance Committee.

IJWA, *continued from page 12*

Future IJWA projects in individual areas of interest will include modeling and simulation of Fleet Battle Experiment Initiatives and Scenarios for specific numbered fleet problems. These projects are being developed to support long-range assessment and analysis in conjunction with the Fleet Battle Experiment effort. Professor **Gordon Schacher** serves as the director of IJWA; Research Assistant Professor **Nelson Irvine** is also a member of IJWA and participated in FBE-G.

CENTER FOR AUTONOMOUS UNDERWATER RESEARCH,

continued from page 12

the direction of Professor **Anthony Healey** is participating in the rehearsal as well as the full-blown exercise Hotel. The Center's role is to coordinate the data from the AUVs and integrate results into the common tactical picture through the NPS TDA (Tactical Decision Aid) which links directly into the Navy's MEDAL (Mine Warfare Environmental Decision Aids Library) system.

Visiting Professor Walter LaBerge, Institute for Joint Warfare Analysis, has been asked by Dr. Richard Chait, head of the National Research Council's (NRC) Board of Manufacturing and Engineering Design, to head a NRC study starting this fall on "Commercial and Military Manufacturing in 2010 and Beyond." The study will examine what is expected to be the nature of flexible tooling, flexible manufacturing, and best practices in those areas and how best the military needs to connect into those activities setting future industrial standards.

PROJECT NOTES

ASIAN SEAS INTERNATIONAL ACOUSTICS EXPERIMENT (ASIAEX)

Research Professor Steven Ramp, Department of Oceanography

Professor Ching-Sang Chiu, Department of Oceanography and Undersea Warfare Academic Group

Oceanographer Fred Bahr, Department of Oceanography

The Asian Seas International Acoustics Experiment (ASIAEX) is a joint project between the United States, People's Republic of China (PRC), Taiwan, Singapore, Korea, Japan, and Russia. The objective of ASIAEX is to understand how the complex littoral environment, i.e., its water column, boundary, sediment and sub-bottom structure and inhomogeneities affects the ray paths, mode structure, propagation loss, and temporal and spatial (both vertical and horizontal) coherence for low-to-intermediate frequency (50-4000 Hz) acoustic transmissions. ASIAEX has two primary components: one is a field study focused on acoustic propagation through complex oceanography in the shelf-break region of the South China Sea; the second is a field study focused on acoustic reverberation and scattering from the seafloor and subbottom in a shallow-water region of the East China Sea.

Under the sponsorship of the Office of Naval Research, Research Professor **Steve Ramp** is the International Scientific

Coordinator for ASIAEX, assisted by Professor **Ching Sang-Chiu**. Professors Ramp and Chiu are coordinating ONR's activities in the South and East China Seas during 2000 and 2001 with the countries collaborating on the project. Two major field efforts are planned; one recently completed in April, the other planned for the spring of 2001. Professors Ramp and Chiu will also assist ONR with the overall coordination of the data distribution and scientific analysis following the execution of the field program.

The April 2000 field effort was conducted aboard the research vessel *R/V ROGER REVELLE*. Owned by the Office of Naval Research and operated by the Scripps Institution of Oceanography, the *REVELLE* is one of the largest and newest ships in the U.S. research fleet. The *REVELLE* departed Pusan, South Korea on 8 April.

The study region selected, namely 28-30N, 126.5-128E, included the continental shelf, shelfbreak, slope and some deep water in the East China Sea. The focus of the cruise was to complete the site surveys involving geophysical and oceanographic measurements to provide some preliminary characterization of the ocean environment. About 80% of the time was spent doing sub-bottom profiling in the region using chirp and low frequency (water gun) sonars. A detailed bottom characterization is needed prior to conducting a shallow water reverberation experiment. These studies were undertaken by Dr. Lou Bartek of the University of North Carolina and Dr. Steve Schock of Florida Atlantic University. Some physical oceanographic observations were also made using current and temperature moorings, the ship's acoustic Doppler current profiler, and the CTD (conductivity-temperature-depth) instrument. Two across-shelf sections of the temperature and



R/V ROGER REVELLE berthed in Pusan, South Korea prior to departure for the ASIAEX spring 2000 cruise to the East China Sea.

--continued on page 15

PROJECT NOTES

ASIAEX, continued from page 14



Professor Ching-Sang Chiu watches a sediment core being logged in the main laboratory of the *R/V ROGER REVELLE* during the ASIAEX 2000 cruise in the East China Sea.



Fred Bahr of the Naval Postgraduate School prepares an Aanderaa current meter for deployment on board the *R/V ROGER REVELLE* during the ASIAEX 2000 cruise in the East China Sea.

Research Professor Steven Ramp presents scientific results from the ASIAEX 2000 cruise to Chinese scientists visiting the *R/V ROGER REVELLE* during a port call in Shanghai. Several scientists from the Institute of Acoustics and the State Oceanographic Agency visited the ship and viewed science presentations in the laboratories.

salinity (and therefore density and sound speed) were made from shallow water on the continental shelf offshore well into the Kuroshio Current. These observations will be used both in choosing the site for the 2001 program and to design equipment that will perform well under the prevailing oceanographic currents.

Following the completion of the scientific mission, the *REVELLE* made a diplomatic call to Shanghai, People's Republic of China, to disembark the Chinese participants and meet with other scientists from the Institute of Acoustics (Beijing and Shanghai) and the State Oceanographic Agency. This trip marks the first time in many years that an U.S. research vessel has touched land in the PRC. The U.S. scientists welcomed the Chinese scientists on board with a display of scientific results from the cruise in the main laboratories, followed by a social with food and beverages provided by the vessel. The Chinese scientists returned the following morning to browse the scientific results in more detail, and to pose for a group picture before departing. Following a fascinating trip back down the Yangtze River to the open sea, the *REVELLE* proceeded to Naha, Okinawa before concluding the cruise in Kaohsiung, Taiwan.

The next step for ASIAEX will be the fourth international scientific planning workshop, to be held June 21-23 in Kona, Hawaii. About 50 attendees are expected from the seven participating nations. Final plans for the 2001 field program will be made at this workshop. The generic "master plan" for the FY2001 field program is shown in Figure 1.

--continued on page 16

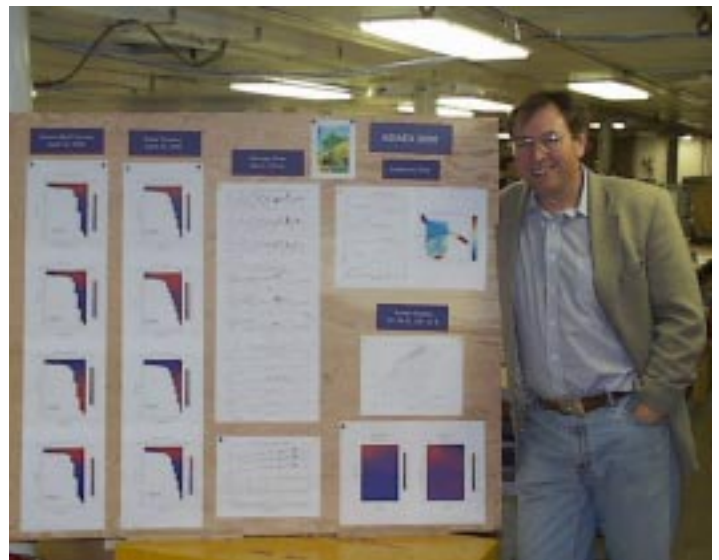

PROJECT NOTES

ASIAEX, continued from page 15

The acoustics experiments will be in full swing at this time, using the support data collected during spring 2000. A multi-ship operation is envisioned, using the *R/V MELVILLE* from the United States and several ships from the bordering nations. The 2001 programs will feature simultaneous very high resolution observations of both the acoustic propagation and the physical oceanography of the medium. Students at NPS will be encouraged to participate in the program. Besides NPS, investigators from several major U.S. institutions will be involved, including the Woods Hole Oceanographic Institution, the Scripps Institution of Oceanography, the University of Washington's Applied Physics Laboratory, the Naval Research Laboratory, the University of Rhode Island, the University of North Carolina, Florida Atlantic University, and Georgia Tech. The results from ASIAEX will yield improved understanding of acoustic propagation in complex shallow water environments. *Additional information on ASIAEX 2000 can be found at www.oc.nps.navy.mil/cruiselive.*

Chinese and American members of the ASIAEX project gather for a group photo aboard the *REVELLE*. From left to right, Professor Ching-Sang Chiu, Mr. Hua, National Taiwan University, Dr. Jim Lynch, Woods Hole Oceanographic Institution, Research Professor Steve Ramp, Mr. Wu and Dr. Yan, Institute of Acoustics, Beijing.

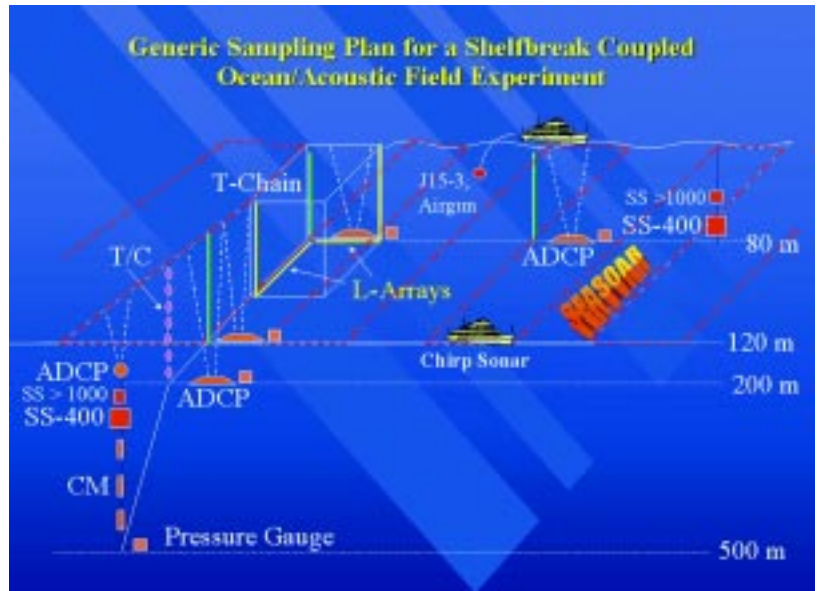

Figure 1. The generic “master plan” schematic for the FY2001 field program.



PROJECT NOTES

INTERNATIONAL PROJECT ON WEAPONS OF MASS DESTRUCTION

Over the last two years, Associate Professor **James J. Wirtz** of the National Security Affairs Department has contributed to a project on “Preventing the Use of Weapons of Mass Destruction (WMD)” organized by Professor Eric Herring of the University of Bristol. Initial findings of the project were presented at the 1998 Pan-European International Relations Conference held in Vienna, Austria. The project, involving an international team of scholars, offered an evaluation of the way members of the North Atlantic Treaty Organization have responded to the threat posed by WMD. Professor Wirtz’s contribution to the endeavor, an article entitled, “Counterproliferation, Conventional Counterforce and Nuclear War,” highlights the role played by U.S. nuclear weapons in counterproliferation attacks against WMD arsenals. The Defense Threat Reduction Agency supported Professor Wirtz’s participation in the project. The results of the project will be published as a special issue of the *Journal of Strategic Studies* (Vol. 23, No. 1).

SEVENTH EXPERIMENT CONDUCTED FOR A2C2 RESEARCH PROGRAM

The Adaptive Architectures for Command and Control (A2C2) research program, sponsored by the Office of Naval Research, has been pursuing a stream of research over the past several years to identify characteristics of organizational design and processes that will improve the effectiveness of defense organizations. The A2C2 research team is comprised of university, government, industry and military participants doing basic-level research involving modeling and laboratory simulation experiments as well as applied research as part of operational activities. Two examples of the latter, tier two research were conducted in 1999. Bridge to Global '99, was a one-week exercise, designed and conducted at NPS by the A2C2 research team in support of Commander, Third Fleet. The 1999 Global Wargame, held at the Naval War College, Newport, RI, utilized an organization modeled by A2C2 researchers and included A2C2 representatives in the assessment team.

The most recent laboratory-based simulation experiment was conducted at the Naval Postgraduate School in February 2000. It builds significantly on NPS A2C2 experiment 4 that was conducted in 1998. The premise of this research is that defense operating environments will continue to become increasing turbulent and unpredictable. Such environmental uncertainty requires increased organizational adaptability and

flexibility. A primary research question is, what are the characteristics of organization structure and process that facilitate adaptability?

The purpose of this most recent experiment was to gather more data on the relationship between organization structure types and performance on unpredicted tasks. Specifically, the research question guiding the design of the experiment asked: When faced with the need to respond to an unanticipated, complex, task, does a structural architecture that requires inter-unit coordination (i.e., nodes with structural interdependence) provide a performance advantage over an architecture that minimizes coordination by using a task-based design (i.e., nodes with structural autonomy)?

Study participants were NPS students from the Systems Management and Computer Science Departments, and the Joint C4I Systems Curriculum. The C4I students acted as the “lead team” assisting in training, assessment and analysis. The other students were assigned to 6-person teams that played the role of a Joint Task Force engaged in a mission using the Distributed Dynamic Decisionmaking-III (DDD-III) simulation software, in the Systems Technology Battle Laboratory at NPS. The NPS A2C2 research team involved in experiment seven included Assistant Professor **Susan Hovecar**, Systems Management, and Associate Professor **Bill Kemple**, Professor **Dave Kleinman**, Research Assistant Professors **Gary Porter**, and **Sue Hutchins**, C4I Academic Group, and **LT Lee Pasaraba**, (USN), a student in the Joint C4I Systems Curriculum who headed the lead team of students assisting with the conduct of the experiment.

The experimental design was a “within-teams” design so that all teams executed the simulation using two structures—one designed for autonomy, and one designed for interdependence—with order balanced across teams to control for any learning effect. The mission scenario used in an earlier experiment was embellished to increase the number of unpredicted tasks to allow for a more effective comparison of the two structures in situations of both high- and low-uncertainty. Multiple measures of both performance outcome (derived from the task accuracy scores generated by the DDD simulator) and process variables (e.g., communication patterns, decision control, speed of response) were gathered and analyzed to provide comparison of the two structural forms under conditions of both high and low task predictability. The results show only limited differences between the two structures, though these are in the direction predicted. However, a more consistent finding suggests that training and improved teamwork processes override structural differences in influencing performance outcomes.

PROJECT NOTES

WIRELESS NETWORKS TO SUPPORT RAPID DECISION-MAKING

Assistant Professor Arnold Buss

Visiting Assistant Professor Paul Sanchez

Department of Operations Research

Introduction

The new IEEE 802.11 standard for wireless computing has sparked research into applying wireless commercial-off-the-shelf (COTS) technology to military problems. For the past year the Loosely Coupled Components (LCC) Working Group has been conducting research into how this emerging technology can best be leveraged to support military decision-making. Wireless computing offers the potential to deploy software systems which are much more dynamic than their predecessors. Our work addresses a number of questions that arise in the context of this emerging technology. The most significant issue is architectural. Wireless technology puts computing in the hands of a completely new set of users, users who are mobile and in a dynamic environment. We need to re-think the nature of the data that will be available and/or relevant, the algorithms, and the way in which results are presented. There are also issues of interoperability, bandwidth, range, and security.

The LCC Working Group has built a wireless network over the past year in Glasgow Hall to provide a "proof-of-concept" testbed. Drawing on this experience, we helped implement and support a wireless network for NPS' Center for Executive Education. These systems have been built on COTS devices and have utilized the 802.11 standard to promote interoperability between different manufacturers' devices as well as different operating systems. We believe that such heterogeneous networks are ultimately more useful for military applications than single-vendor turnkey solutions.

Architectures based on wireless computing are fundamentally much more dynamic than the more familiar wired technologies. However, many of the protocols that support computer networks are still rooted in static, wired networks. Most software systems, both commercial and DoD, have been designed with a single computer in mind. Only recently have the ideas of distributed computing, such as internet-based applications, begun to filter into software. Often the network elements of the design are added after the fact on pre-existing single platform applications. Even when designed with networking in mind, it is clear that most software developers had a static wired network model behind the design. Building applications that run on and exploit the capabilities of networks of mobile wireless is a research goal of the LCC group.

Research Goals

The LCC Working Group has worked for the past three years on new software architectures to support real-time decision-making. Inspired by *Joint Vision 2010*, the group has addressed problems relating to how software must be designed to take full advantage of both wide-area and local computer networks.

The process of exploiting these new technologies begins with the distinction between data and information. Most software planning systems, both COTS and DoD, have not made this distinction. Indeed, many applications appear to be directed towards how to display data to the user. It is clear that there will be an increasing abundance of data. It should also be clear that the implicit assumption that more data are automatically better for the decision-maker is false. There is a major risk that a decision-maker will be overwhelmed by too much data and will not be able to "see the forest for the trees."

The software architectures the LCC Working Group has been developing address the problem of data overabundance by applying Operations Research (OR) models to the data to produce information. This information is of much greater use to the decision-maker than the raw data.

The LCC architecture supports military applications in such basic tasks as the location of units, integration of intelligence information, and displaying data and information on maps. While technologies such as wireless computers and ubiquitous networks enable the fusion of existing and real-time data, more is required to support real-time decisions.

Some systems that have recently been developed using this architecture have enabled a decision-maker to quickly build graph and network models from real-time data for road, computer, or telecommunications networks and apply algorithms to these graphs. These algorithms enable the user to extract useful information, such as the shortest route between units' location and an objective [Bilyeu, 1998]; optimal arcs to interdict [Moriarty, 1997]; and which medical units should be matched with which tasks in a dynamic, rapidly changing environment [Bradford, 2000].

Last year the LCC Working Group provided support to a pair of SOLIC theses by **LT Robert Moss, USN** and **LT Steven Tripp, USN** [Moss, 1999; Tripp, 1999]. They explored some issues in wireless computing regarding range, bandwidth, and detectability of signal strength. Their work

--continued on page 19

PROJECT NOTES

WIRELESS NETWORKS, *continued from page 18*

represented our initial foray into wireless networking and provided a dramatic example of the power of wireless networks by carrying a wireless computer in an aircraft flying over the Monterey Bay. Using a directional antenna pointed from the aircraft to another antenna on the roof of Ingersoll Hall, they were able to maintain connectivity for up to 15 miles. From his office on campus, RADM Chaplin e-mailed to them a request for a picture of the Santa Cruz boardwalk while they were in the air. The desired image was received by e-mail less than 15 minutes later [Campus News, September 16, 1999].

Architecture

The LCC Working Group has been working on two types of wireless network implementations. One is a relatively static environment in which wireless clients arrive and leave but the

infrastructure is more or less fixed. This is the approach we have taken in Glasgow Hall. This quasi-static wireless network is appropriate when there is a need or desire to add the flexibility of wireless computing to existing wired networks. The result is a mixed network, consisting of both wired and wireless computers.

The second implementation is much more dynamic and comprises a wireless computer network that has an extremely small physical footprint and can be deployed very rapidly. It consists primarily of computers smaller than a notebook. Turning on these small units forms the network. It evolves and is reconfigured with each additional computer. As each device appears on the network, it “discovers” the existing devices and announces its presence to the network. We have dubbed this a “LAN in a Bag” because a complete network can be fit into a container the size of a conventional computer bag.

Currently the IEEE 802.11 standard requires the presence of an access point, a device that serves a role analogous to that of a hub in a wired Ethernet network. We have successfully used access points from two manufacturers: a Lucent WavePoint and an Apple AirPort. Currently the configuration in Glasgow Hall relies on both for coverage of the second floor, as shown in Figure 1.

The placement of the access points in Figure 2 provides nearly full coverage of the second floor, as well as partial coverage outside and on other floors. Note the striped block in Figure 1—this area is a storage closet with metal shelving and chain-link fence in the middle, and casts a significant radio “shadow.” This necessitates a greater density of access points in that portion of the building to guarantee adequate coverage. The use of Apple’s AirPort hubs is extremely cost-effective, since they are less than \$300 apiece. This compares quite favorably to Lucent’s equipment, at approximately \$1200 for a single WavePoint.

The access points provide gateways between the wireless clients and the wired LAN, as shown in Figure 2. The wired LAN provides access to the Internet, thus enabling the wireless clients to transparently utilize all of the Internet’s resources in addition to those of the wired LAN.

-- continued on page 20

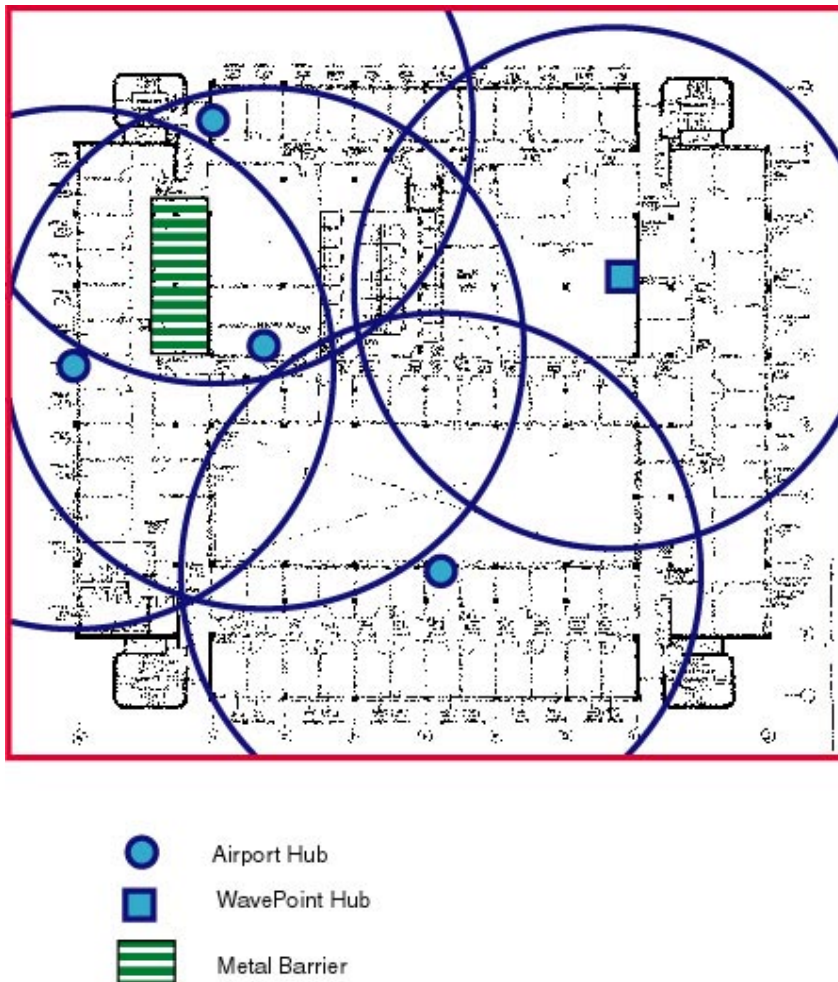

Figure 1. Access Point Coverage of Glasgow Hall 2nd Floor

PROJECT NOTES

WIRELESS NETWORKS, *continued from page 19*

Security

Security issues are a concern whether operating in a wired or wireless environment, but the broadcast nature of wireless computing brings them squarely to the forefront. Security issues can be broken into four broad categories: authentication, data protection, traffic patterns, and denial of service. The first two can be handled with a combination of encryption technology and/or Virtual Private Networks (VPNs). The latter two remain areas of vulnerability and are part of the ongoing research.

Current generation wireless equipment has hardware encryption available out of the box. It uses symmetric shared-key algorithms, and acts as the first layer of security. One cannot join the network without knowing the key. We advocate that all transmissions should also be software encrypted.

Authentication is often handled by a challenge/response system. A classic challenge/response system is the use of a password, but password schemes are most emphatically not sufficient for authentication. In an environment where information is broadcast through the airwaves using COTS technology, it must be assumed that message packets, and therefore passwords, will be intercepted. It follows from this that authentication must be based on a mechanism in which the response is never twice the same, but is nevertheless recognizable as correct. Public key encryption (PKE) technologies provide us with exactly such a mechanism. When a client attempts to make contact it must identify itself to the server. The server issues a challenge in the form of a randomly generated numeric value, which has been encrypted with the client's (known) public key. The client decrypts the number using his private key, then encrypts it with the server's (known) public key and returns it. A successful exchange establishes that both machines are who they claim to be, since to decrypt the number requires access to the private key that uniquely corresponds to the known public key. This eliminates both mimics (since the content of the challenge will change every time) and "man in the middle" attacks. It also has the potential to allow access rights to information to be restricted on an authorized user or authorized client basis, unlike the hardware encryption described above.

The random number that was exchanged for authentication purposes can be used as a key for symmetric key encryption of

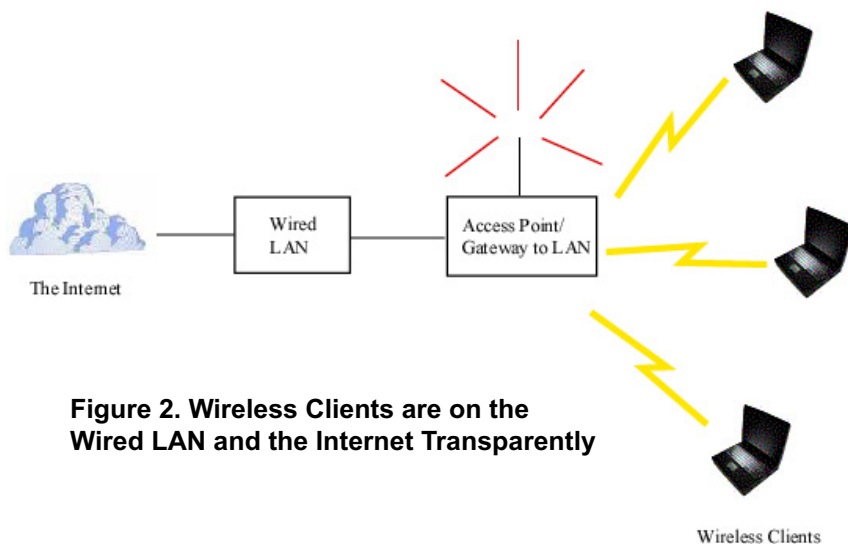

Figure 2. Wireless Clients are on the Wired LAN and the Internet Transparently

subsequent data. This is the mechanism used by VPN software to establish "secure tunnel" connections. Note that since the challenge is unique for each client session, the resulting encrypted channel is also unique (unlike the hardware encryption performed on the radio signals). This acts as a second layer of protection on the information content - even if the enemy has captured some of our equipment or succeeded in breaking the hardware encryption, they will not be able to view transmissions to other machines. Rather than assuming that we can keep the opposition out of our network infrastructure, we assume that they are present and make it impossible for them to view content regardless.

Another area of data vulnerability is from captured equipment. We are just beginning to investigate how technologies such as the Java-powered iButton can be used to prevent captured computers from being used by enemy forces. iButtons are miniature (about the size of a watch battery) computing devices which can be embedded in a ring, on a key chain, or mounted on a dog tag, and have the capability of doing public key encryption for authentication, as described above. With iButtons, smart-cards, or some equivalent technology, we anticipate the capability of authenticating the user to the computer itself. In other words, without the proper iButton and biometric data the computer would refuse to operate.

Oddly enough, the broadcast nature of wireless is somewhat helpful with regard to traffic pattern analyses. However, with sufficient effort it is likely that the opposition can detect

-- continued on page 21

PROJECT NOTES

WIRELESS NETWORKS, *continued from page 20*

acknowledgement responses and use these to identify patterns in transmission

Denial of service represents a potential vulnerability for wireless computing. The current generation of equipment uses spread spectrum and frequency hopping technologies but, as with any electromagnetic communications, is vulnerable to jamming.

Equipment

The Institute of Electrical and Electronics Engineers, Inc. (IEEE) created the 802.11 standard, which provides for vendor-independent interoperability of wireless devices. The original IEEE802.11 standard provided for transmission speeds of up to 2 megabits per second (Mb). An extended standard was adopted in late 1999 which provides for 11Mb communications. The channel can be either encrypted or unencrypted. Encryption is available at two security levels - 56 bit keys; or 128 bit keys, which provide greater security but are subject to export restrictions from the US.

Wireless networking in IEEE802.11 mode is topologically similar to wired networking using a hub. The access point must be connected to the internet via standard connections, such as ethernet or modem, if WAN (Wide Area Networking) connectivity is desired. Each client computer must have an IEEE802.11 compliant device, comparable to the NIC (Network Interface Card) used for ethernet connectivity. This is usually in the form of a PC card which fits into the standard PCMCIA slot available on virtually all laptops. Since desktop systems are usually viewed as non-mobile, wireless devices for them are much less common. However, ISA or PCI PCMCIA adapters are relatively inexpensive and enable desktop systems to join wireless networks. Regardless of whether they are laptop or desktop systems, client computers talk to the access point just as ethernet clients communicate with a hub, except that the communication is done by radio rather than by wire. Once properly configured, communications by wireless device are as transparent to the user as the wired connection currently on your desktop system.

In order to have "roaming" capabilities, all access points and clients must share the same IP address space, be configured to the same network name, and, if encryption is being used, share a common key. The range of the wireless connection is impacted by numerous factors, but we have found it to be dominated by distance between client and access point and the amount of metal (girders, wire mesh, metal bookcases, etc.) along the signal path. Our experience is that reception is

reasonable within a disk of radius ~150-300 ft centered on the access point. We have provided coverage for the entire second floor of Glasgow Hall using four access points.

In terms of specific vendor products, we are currently using a combination of Apple "Airport" and Lucent "Orinoco" technologies. Lucent currently offers three grades of cards, all operating at 11Mb — Gold cards can do 128b encryption; Silver cards do 56b encryption; and Bronze cards have no encryption capabilities. Any of these cards can be used for client connectivity or plugged into Lucent's hardware or a PC running Linux to act as an access point. At the time at which this article is being written, the cards cost ~\$200 each, while Lucent access points are ~\$1200 (without the required card). Apple makes the incredibly low-cost "AirPort base station," which sells for under \$300, contains a Lucent silver card and modem, and can provide both DHCP (Dynamic Host Configuration Protocol) and NAT (Network Address Translation) capabilities. There are two drawbacks to the airport. First, it can only be administered from a computer running MacOS. However, a quick calculation shows that an iMac + airport (~\$1300) is cheaper than an Orinoco access point + Wavelan card (~\$1400), and a price differential of ~\$1100 is realized with each additional access point. The second drawback is that the Apple airport contains a silver card, and is thus limited to 56-bit encryption. Since the key must be common to the entire network for roaming, this affects security for the entire system. However, this limitation is easily remedied with a screwdriver and a Lucent gold card. While this solution raises the cost of an Apple airport based system, it still is substantially cheaper than Lucent's solution.

It is worth pointing out that IEEE802.11 compliance provides us with vendor interoperability, and thus removes vendor-specific dependence. We have successfully built a network containing a combination of hardware and systems including Intel PCs, Lucent and Apple wireless equipment, and running various combinations of Windows, MacOS, Linux, FreeBSD, and OpenBSD. By focusing on open standards at the telecommunications level rather than at the application level, we have achieved seamless interoperability. This is significant for two reasons. First, the design allows for growth and evolution - individual components can be upgraded as improved versions become available as long as IEEE802.11 compatibility is maintained. Second, it increases the utility of the design for joint operation with allies or civilian organizations, such as the Red Cross or other rescue

-- *continued on page 49*

STUDENT RESEARCH

THE DECISION TO ALLOW WOMEN INTO MILITARY COMBAT POSITIONS: A STUDY IN POLICY AND POLITICS

LT Kristen W. Culler, United States Navy

Master of Science in Leadership and Human Resources Development – May 2000

Advisors: Senior Lecturer Alice Crawford and Professor Mark Eitelberg, Department of Systems Management

Women in the United States military have served in every major conflict since the Revolutionary War, but their acceptance in the military has not always been a given. Similarly, the roles of military women have been dictated by and limited by Presidents, members of Congress, military leaders, and society. The progression has been fairly slow and steady: “Molly Pitcher” in the Revolutionary War; women as cooks and seamstresses during the Civil War; female nurses and pilots in the two World Wars; women near the battlefield in Vietnam and Panama; and a visible showing in Operation Desert Storm, where women fought alongside men and were both captured and killed.

In 1991, the United States Congress reviewed and reconsidered the combat aviation exclusion laws that barred women in the Navy, Marine Corps, and Air Force from being assigned to aviation squadrons that had combat missions. Rescinding the combat exclusion laws would have a great impact on the history and traditions of the United States military and of the nation as a whole. The decision to repeal such laws and, subsequently, the laws banning women from combat ships reflected a complete shift in beliefs traditionally held by Americans concerning a woman's role in society, the role of men as protectors of women, and certain differences in physical capability between men and women.

The focus of this thesis is two-fold. First, the thesis reviews the history of women in combat and the major issues involved. Second, through research and interviews with key individuals, examines the Congressional decision and resulting actions. Interviews with Congressional staff members, high-ranking Navy and Army officials, Secretary of Defense persons, and women's rights activists revealed consistencies in ideas about how the decision was made to lift combat exclusion laws.

The research and interviews led to some key insights. Of the issues presented in support of the legislation, the ones that had the most impact on decision makers in Congress were military necessity, the Risk Rule's current inability to “protect” women, and a basic push for equal rights. The success of women in Operation Desert Storm proved to be a hugely

positive influence, possibly the single most important factor in explaining how and why the decision was made. The arguments that carried the most weight in opposition to the change were the less-than-overwhelming support of female enlisted members, the possibility of decreased combat effectiveness, and the unresolved question of the draft. Some of the other issues were largely overlooked in Congress. Parenting concerns and gender differences were left to the military to resolve at some future, unspecified point in time. And despite all the arguments against women in combat that were based on readiness issues, Congress and the administration held onto a general “wait and see” position instead of seeking an immediate resolution.

As in any major political decision, politics played a small but noticeable role in the process. Another issue that surfaced in an interview was the fact that top military leaders appeared to be more concerned in the early 1990s with fighting legislation to allow open service of homosexuals. A final point emerging from interviews was how critical timing of all relevant issues and support was key to this decision. The fight for expanded roles for women in the military was not a new one when it resurfaced in 1991, but the timing had never been better. The arguably logical progression of women's responsibilities in the armed forces had been on-going; the next step could quite possibly have been breaking down the barriers of combat aviation. Many events came about in a relatively short period of time, including the following:

- Operation Desert Storm showed that society was not against women in combat and placed the issue at the forefront of people's minds
- The power of the women's vote was great enough to be a consideration among members of Congress
- Women had eroded many negative stereotypes in the military
- More women held policy-making positions than ever before
- Expanded roles of women in society (doctors, police force, firefighting, etc.) showed women's capabilities
- The voting procedure in Congress during the women-in-combat debates was uncommon
- A Democratic President was elected in 1992
- The Presidential Commission was established in 1992.

No longer just filling limited roles as seamstresses, cooks, and support persons, women are now maintaining careers on destroyers, flying in F-15 Eagle squadrons, or catapulting off of aircraft carriers. Studying the Congressional proceedings that allowed them to assume such roles leads to a more in-

-- continued on page 23

STUDENT RESEARCH

CALCULATION OF BARRIER SEARCH PROBABILITY OF DETECTION FOR ARBITRARY SEARCH TRACKS

LT Wyatt J. Nash, United States Navy
Master of Science in Operations Research – March 2000
Advisors: Professor James Eagle and Associate Professor Lyn Whitaker, Department of Operations Research

The Surface Warfare Development Group is responsible for conducting the Ship Anti-Submarine Warfare Readiness/Effectiveness Measuring Program. They currently employ a standard set of measures for evaluating the performance of shipboard anti-submarine warfare sensors. This research investigates several new performance-based measures to determine if they are more suitable than the standard measures for evaluating the conduct of anti-submarine warfare barrier searches. The investigation simulates various searches to determine probability of detection, calculates the proposed measures and compares the two. The results indicate that the proposed measures can be improved. A barrier search algorithm exploiting target-relative space ideas is developed which generalizes the classical search theory results for predicting probability of detection during barrier search.

UH-60 BLACK HAWK DISTURBANCE REJECTION STUDY FOR HOVER/LOW SPEED HANDLING QUALITIES CRITERIA AND TURBULENCE MODELING

LCDR Steven J. Labows, United States Navy
Master of Science in Aeronautical Engineering - March 2000
Advisors: Professor E. Roberts Wood, Department of Aeronautics and Astronautics, March B. Tischler and Chris L. Blanken, NASA Ames Research Center

Helicopters operate in an environment where task performance can easily be affected by atmosphere turbulence. This thesis discusses the airborne flight test of the Sikorsky UH-60 Black Hawk helicopter in turbulent conditions to determine disturbance rejection criteria and to develop a low speed turbulence model for helicopter simulation. A simple approach to modeling the aircraft response to turbulence is described by using an identified model of the Black Hawk to extract representative control inputs that replicate the aircraft response to disturbances. This parametric turbulence model is designed to be scaled for varying levels of turbulence and utilized in ground or in-flight simulation. Flight control cutoff frequency data are also analyzed to support design criteria for gust rejection handling qualities.

WOMEN IN MILITARY COMBAT POSITIONS, *continued from page 22*

depth understanding of how difficult or sensitive decisions have been made in the past and will likely be made in the future. Congress must weigh a considerable number of factors, including society's views, pressure from constituencies, opinions of the President and top military leaders, and issues of correctness and morality. Such matters were taken into account in the women-in-combat resolution, but as the interviews explain, timing and momentum were the unexpected weights that probably tipped the scale.

PROPAGATION OF A TWO-PHASE DETONATION ACROSS A COMPOSITIONAL DISCONTINUITY WITH GEOMETRIC DIFFRACTION

LT Todd Hofstedt, United States Navy
Master of Science in Aeronautical Engineering – June 2000
Advisors: Research Assistant Professor Chris Brophy and Distinguished Professor David W. Netzer, Department of Aeronautics and Astronautics

The research program involves the modification and use of an existing pulse detonation engine (PDE) to investigate the detonability of a JP-10/air aerosol. The detonation of a JP-10 aerosol in air has proved more difficult than was originally anticipated. The use of a small JP-10/oxygen predetonator to provide direct initiation results in a transition region with a compositional discontinuity and geometric diffraction. Propagation of a detonation into such a region is very complex but critical to the re-establishment of the detonation wave in the JP-10/air mixture. A high-speed camera will be used to image the wave in the transition region and provide spatial information. High frequency pressure transducers will be used along the combustor axis to determine wave speed, deflagration-to-detonation distances, and any location where the detonation wave re-establishes itself. Optical imaging of the fuel distribution will also be performed using a fluorescent dye-seeded fuel to allow quantitative information on the fuel distribution existing in the combustor as a function of space and time. The ultimate goal is to determine the conditions required to ensure reliable re-establishment of a detonation wave in the JP-10/air aerosol mixture. The practical application of a PDE to a tactical missile propulsion system requires - among other things - the use of liquid fuels because of their higher energy densities and the minimization/elimination of any gaseous oxidizer for the predetonator unit due to the increased hazards and mass of the required tanks.

STUDENT RESEARCH

STUDENT FELLOWSHIPS AWARDED BY THE SPACE AND NAVAL WARFARE SYSTEMS CENTER-SAN DIEGO

The Space and Naval Warfare Systems Center-San Diego (SSC-SD) sponsors a Research Fellowship Program at the Naval Postgraduate School (NPS). The program was instituted to promote NPS' partnership with SSC-SD's research focus areas, lay the groundwork for future technical and project management assignments, and foster long-term professional associations with SSC-SD's technical personnel and management. To date, there have been over 30 fellowships awarded to NPS students. The fellowship includes a \$10,000 award to support the student's thesis research. The most recent awardees are **CAPT Carl P. Brodhun, USMC, LT Keith A. Peterson, USN, LT Michael K. Itakura, USN, Maj Kevin M. Shea, USMC, and LT Peter M. Cutsumbis, USN.**

Working with Associate Professor **Cynthia E. Irvine**, Department of Computer Science, Capt Brodhun's research will focus on the prioritization of information assurance (IA) technology in a resource constrained environment and evaluate the Situational Influence Assessment Model (SIAM) when used as a decision template application.

LT Peterson will be working with Associate Professor **Indranath Dutta** of the Department of Mechanical Engineering to formulate a model that will identify and optimize a fabrication process that will produce the highest quality semiconductor on sapphire.

LT Itakura will apply concepts and techniques involving the GLOBALSTAR Satellite Telecommunication System in support of national security objectives. His advisor is **Vicente Garcia**, the National Security Agency Cryptologic Chair Professor.

Maj Shea, working with Professor **Murali Tummala** of the Department of Electrical and Computer Engineering, will focus on internet working and protocol issues in the implementation of software radio technology for military applications.

The development and testing of a wide-band communication antenna for submarine communications is the area of research for LT Cutsumbis and his advisor, Research Associate Professor **Jovan Lebaric** of the Department of Electrical and Computer Engineering.

DEVELOPMENT OF THE BEARTRAP POST MISSION PROCESSING SYSTEM 2000 (S2K) HTML HELP PROJECT

LT Edward D. McCabe, United States Navy

LT Christopher D. Stone, United States Navy

Master of Science in Systems Technology — June 2000

Advisors: Professor Murali Tummala, Department of Electrical and Computer Engineering, and Research Assistant Professor Gary Porter, Command, Control and Communications Academic Group

This work is part of an ongoing effort to integrate the separate BEARTRAP post mission analysis tools into an application operating in a Microsoft Windows environment. This new integrated system will contain software modules designed to replace the array of diverse processing systems currently being used for BEARTRAP post mission analysis. This thesis develops the HTML Help features to support users of the BEARTRAP Post Mission Processing System 2000 (S2K) software application. This application allows an analyst to gather context sensitive HTML Help to support procedural use of the BEARTRAP Post Mission Processing System as well as background information on related fields of study. This document describes the background and development of the HTML Help project with particular emphasis on critical areas fundamental to the HTML Help project development and aspects requiring further research and development.



CAPT Eugene Cernan, USN (Ret.), the last man to walk on the moon during the Apollo 17 NASA mission and a former NPS graduate (M.S. in Aero Engineering-January 1964), returned to NPS as the Superintendent's Guest Lecturer recently.

PARTNERSHIPS

EDUCATIONAL CONSORTIUM FOR PRODUCT DEVELOPMENT LEADERSHIP IN THE TWENTY FIRST CENTURY (PD-21)

A Memorandum of Agreement was recently signed between the Massachusetts Institute of Technology (MIT), the University of Detroit Mercy (UDM), Rochester Institute of Technology (RIT), and the Naval Postgraduate School (NPS) concerning an educational consortium and a master's degree program in product development. This new consortium called PD-21, the Education Consortium for Product Development Leadership in the 21st Century, will employ processes of continuous interaction and feedback from its industry partners to ensure quality.

Participants in the consortium include the three founding universities of MIT, UDM, and RIT, the Naval Postgraduate School, MIT's Center for Innovation in Product Development, and industry partners such as Ford, General Motors, IBM, ITT, Polaroid and Xerox. The PD21 consortium feels that the partnership with industry signifies their commitment to assisting U.S. industry to position itself as a world leader well into the next century.

The master's degree curriculum, developed initially at MIT's System Design and Management Program in close consultation with industry, leads to a joint degree targeted to help experienced engineering professionals move into leadership and management positions. The curriculum is aimed at the end-to-end product development process, emphasizing the integrated systems perspective needed to conceive, create, launch, and support today's increasingly complex products. The curriculum includes core courses in product development leadership, system architecture, system engineering, and system and project management, along with a set of foundation courses that provides both engineering depth and management breadth.

The unique collaboration between universities and private industry will help companies compete more successfully in today's global marketplace and bring products to market faster and more efficiently. Helping engineering professionals move into leadership and management positions will create a workforce that is well versed in the latest innovations, throughout the product development process. "The PD21 consortium offers a new model in graduate engineering,

management, and product development education in the U.S. This curriculum incorporates two powerful streams of information flowing from engineering and management into the curriculum, the latest concepts in product development provided by university research, and the experiences of industry, developed through specialized case studies," said Warren Seering, Director of the Center at MIT at the time of the founding of PD-21.

Dr. **Carson Eoyang**, Director of the Office of Continuous Learning, will be the NPS lead for PD-21. Dr. Eoyang recently joined the NPS faculty after serving in several senior executive positions at the Office of Science and Technology Policy, the Federal Aviation Administration, the National Aeronautics and Space Administration and the Vice President's National Performance Review. Previously he was on the NPS faculty conducting research and teaching in project management and human resource management. In addition to holding a degree in physics from MIT, he also earned a M.B.A. from Harvard and a Ph.D. from Stanford.

UNIVERSITY OF CALIFORNIA-SANTA CRUZ AND NPS RENEW COOPERATIVE AGREEMENT

The University of California, Santa Cruz (UCSC) and the Naval Postgraduate School (NPS) have continued a general agreement of cooperation in order to further the education, research and public service programs of the two institutions. The overall agreement is broad in scope and flexible in its implementation. UCSC is one of the ten campuses of the University of California system. It is organized into the Division of Arts, Division of Graduate Studies, Division of Humanities, Division of Natural Sciences, Division of Social Sciences, and a School of Engineering. NPS is organized into three divisions: Computer and Information Sciences and Operations, Science and Engineering, and Operational and Policy Sciences. Common interests and objectives in educational, research, and public service activities unite NPS and UCSC. The objective of the present agreement is to increase the educational, research and public service relationships between the two institutions where there is mutual interest in establishing cooperative and collaborative programs.

PARTNERSHIPS

MARINE CORPS OPERATIONS RESEARCH BILLET ESTABLISHED AT NPS

A Memorandum of Understanding between the U.S. Marine Corps Combat Development Command (MCCDC) and the Naval Postgraduate School (NPS) formalizes the establishment and administration of a permanent billet for a Marine Corps Operations Research representative on the faculty of the Department of Operations Research (OR) at NPS. This step was initiated in light of the increased USMC student population in the Operations Research curricula.

The USMC Operations Research representative will be a LtCol, MOS 9650. The position will function as a liaison between the OR Department at NPS and the Director of the Studies and Analysis Division, MCCDC, the current Occupational Field sponsor. The USMC OR representative will serve an advisor, teacher and mentor to USMC officers, review current approved and disapproved studies as outlined

in Marine Corps bulletin 3902 and determine if current NPS thesis work supports these study efforts, and travel to USMC commands in order to educate Marine Corps leaders and personnel on the capabilities resident at NPS and to actively solicit research opportunities not captured by the formal U.S. Marine Corps Study Management System.

CNO ASSESSMENT DIVISION (N81) AND NPS VALUE INTERACTION

The Chief of Naval Operations-Assessment Division (N81) and the Naval Postgraduate School formalized their relationship through a Memorandum of Understanding. The value of the interaction between N81 and NPS can only strengthen

-- continued on page 27

ARMY GAME PROJECT

A Memorandum of Agreement recently entered in to by the Office of the Assistant Secretary of the Army for Manpower and Reserve Affairs (OASA(M&RA)) and the Naval Postgraduate School (NPS) establishes a relationship for NPS to examine various Army support issues with respect to

the utilization of game technology and the Internet. The game development effort will leverage the resident expertise within the Naval Postgraduate School's Modeling, Virtual Environments and Simulation (MOVES) Academic Group, and the NPSNET Research Group.



The Honorable Patrick T. Henry, Assistant Secretary of the Army, Manpower and Reserve Affairs, toured the Modeling, Virtual Environments, and Simulation Laboratory during a recent visit to NPS. Pictured with Mr. Henry are (from left to right): NPS Provost Richard Elster, LTC Casey Wardynski, USA, (Henry), Professor Michael Zyda, Chair of the MOVES Academic Group, and Research Assistant Professor Michael Capps (seated), MOVES Academic Group. Missing from the photo, but key to the Army Game Project, is Research Professor John Hiles, also of the MOVES Academic Group.

PARTNERSHIPS

INTERNATIONAL HEALTH RESOURCES MANAGEMENT PROGRAM ESTABLISHED

A Memorandum of Agreement initiated between the Defense Security Cooperation Agency (DSCA), Navy International Programs Office (NIPO), and the Naval Postgraduate School (NPS) formalizes the establishment of the International Health Resources Management (IHRM) at NPS. In accordance with the objectives set forth in Public Law 101-513 and subsequent legislation pertaining to the Expanded International Military Education and Training (E-IMET) Program, the mission of IHRM is to promote global economic, social and political stability and to advance the principles of human rights and democracy through executive education for all those who influence the decisions of government related to healthcare management in both the military and civilian sectors.

Healthcare managers and providers around the world all face the problems associated with sustaining their organizations in times of change and meeting the requirements of providing medically effective, economically efficient health care with equitable access for all beneficiaries. Effective leadership action requires the combined effort and collaboration of the leaders from all healthcare-related sectors and agencies. The complexity of healthcare systems today creates the need for increased management education and greater international cooperation to adequately deal with the issues involved.

The IHRM program responds to this need. IHRM provides management education, executive coaching and organizational

CNO ASSESSMENT DIVISION (N81) AND NPS VALUE INTERACTION, *continued from page 26*

their programs and further develop the two entities. N81 and NPS agree to provide reasonable cooperation in a variety of joint academic, educational, and analytical activities that shall include, but will not be limited to: organizing, promoting staffing and coordinating long and short term faculty and student exchanges; assisting in securing thesis/research tours for qualified students; performing joint research cooperation and curriculum development; participating in seminars, academic meetings and other professional development activities; and exchanging academic materials and other information. In addition, both organizations agree to actively participate and support the Integrated Warfare Architecture (IWAR) process. The agreement also continues the support for the Chair of Applied Systems Analysis at NPS.

NATIONAL GUARD BUREAU AND NPS PARTNER TO PROVIDE EDUCATION ON CIVIL-MILITARY PROGRAMS

The recently signed Memorandum of Agreement between the Naval Postgraduate School (NPS) and the National Guard Bureau (NGB) provides for National Guard enrollment in NPS Curriculum 689, a fully accredited Masters Degree Program in International Security and Civil-Military Relations. The curriculum is structured to help meet the educational requirements of the National Guard, and ensure that its graduates are exceptionally well prepared to provide leadership on national security issues.

National Guard enrollment in the 689 Curriculum may be in either the one-year resident version or the distributed learning variant. The scope of the agreement also outlines the importance of scholarly research on National Guard-related issues by NPS faculty in order to provide NGB officers with leading-edge education and training.

consulting for military leaders and their civilian counterparts built around the unique needs and interests of each country. Using an experiential approach, IHRM assists organizations in building their management capacity through a multi-phased service involving assessment of their management education and training needs, development of a consensus strategic action plan, identified follow-up actions, and impact evaluation. Participants acquire knowledge and practice skills in transformational leadership, strategic planning, analytical problem solving, organizational change management, performance measurement, collaboration, and communication. These professionals then transfer their skills to their colleagues and thereby build the capacity of their organizations.

NPS has established the Defense Healthcare Management Institute (DHMI) to serve as the focal point for healthcare education and training services. In addition to supporting the IHRM program, the mission of DHMI is to identify, develop, market, and manage education and training programs for research, teaching, coaching, and consulting related to the management of military healthcare systems and services, in support of Department of Defense (DoD) requirements. Lecturer **Paul J. Fields** has been appointed as the Director of DHMI.

TENANT RELATIONSHIP

PARTNERSHIP WITH TENANT COMMAND PRODUCES A WIN-WIN SITUATION

The Naval Postgraduate School hosts several tenant commands at their site in Monterey. This co-location provides opportunities and, in turn, benefits to both organizations. TRAC-Monterey, an NPS tenant, actively seeks faculty support for a range of combat modeling projects. This article describes selected current and recent research projects at TRAC-Monterey and highlights collaborative work with NPS faculty and students.

Professor **Luqi**, Professor **Valdis Berzins**, and Associate Professor **Man-Tak Shing** (Computer Science) supported MAJ (USA) Gerald M. Pearman's HLA (High Level Architecture) Warrior project. With a team of students, they developed a class design of the Janus combat simulation by evaluating several hundred thousand lines of Janus FORTRAN code and documentation. The class design served as a blueprint for code developers re-engineering Janus and recoding it in the C++ computer language. The project applied advanced computer simulation technologies such as making the new simulation HLA compliant, integrating an innovative system architecture, developing an object-oriented design, using state-of-the-art graphical user interfaces, and designing and implementing a modular terrain component. The re-hosted simulation has provided valuable lessons to the modeling and simulation community for the next generation of Army military simulations.

Assistant Professor **Arnold Buss** (Operations Research) is working through TRAC-Monterey with LtCol Allen Olsen, USMC, (NPS OR '98) and MAJ Simon Goerger, USA, (NPS CS '98) at TRAC-WSMR (White Sands Missile Range). They are part of a team developing COMBAT XXI, the next generation analytical simulation of combined arms conflict at the tactical (battalion and brigade) level for the Army and Marine Corps. Professor Buss' major contribution to the project is Simkit, a discrete event simulation framework based on the event diagram paradigm. Both students and faculty from the OA and MOVES curriculum use Simkit extensively for instruction and thesis research. The COMBAT XXI development team is using Simkit in their prototype development and is evaluating Simkit for production use in COMBAT XXI.

TRAC-Monterey is the principal research activity for the U.S. Army Training and Doctrine Command (TRADOC) Analysis Center (TRAC) headquartered at Fort Leavenworth, Kansas. TRAC-Monterey is the Army's Advanced Simulation Concepts Research Center. Its mission is to perform credible and relevant research in selected topical areas to advance Army warfighting doctrine, training, and analysis. TRAC-Monterey accomplishes research in two major areas: (1) high-level computer simulations concepts and advanced technologies for modeling military operations focusing on system interoperability in distributed environments; and (2) practical, real-world military operations research problems of importance to the Army. TRAC-Monterey sustains a strong outreach program that maintains close ties between TRAC and various Army commands and agencies.

TRAC-Monterey sponsors practical, academically and professionally enriching military oriented "experience tours," course projects and Masters Theses for officers from all branches of service attending the Naval Postgraduate School (NPS). World-class faculty and students from the Naval Postgraduate School (NPS) support the Center's research initiatives. TRAC-Monterey's research program offers NPS faculty a broad range of opportunities for studying meaningful, challenging applied problems that support NPS curricula and enhance professional development. TRAC-Monterey's research program is particularly well suited to military officers who wish to apply many operations research, applied mathematics, engineering, and computer science concepts studied in the classroom to solving real-world military problems.

Research Assistant Professor **Wolfgang Baer** (Computer Science) has been supporting MAJ (USA) James Illingworth's TRACER/FSCS (Future Cavalry Scout System) project. In the first phase they modified Professor Baer's micro-terrain database program, Perspective View on NT (PVNT), to accept the required input parameters and produce the required output data streams for the study. In the second phase they worked with tactical experts at TRAC-Leavenworth to build the required scenarios for the study. In the final stage, they executed the scenarios on the modified PVNT platform. Planners and decision-makers will use the results of this project to determine whether micro-terrain can be used in the Research & Development phase of adding new or replacing current weapon systems in the United States Army inventory.

Research Professor **John Hiles** (Modeling, Virtual Environments and Simulations) is working with **Capt Mark Tanner**, USAF to develop a virtual primary care clinic designed to provide an integrated training model for the primary care management teams for the Air Force's Air Education and

--continued on page 29

TENANT RELATIONSHIP

PARTNERSHIP PRODUCES A WIN-WIN SITUATION, *continued from page 28*

Training Command and DOD. They plan to develop an agent based simulation, called SimClinic, that will exercise the primary care team in the decision making process. Senior staff personnel with the Air Force Medical Services (AFMS) will interact in a virtual clinic simulation with Primary Care team members by providing decisions based on their roles in response to the computer-based scenario. Participants will be able to train hospital management skills and optimize patient care issues (access, scheduling, referral, follow-up, education, etc.), resourcing, space utilization and patient flow, staffing, and other related issues.

Assistant Professor **Keith Snider** (Systems Management) is working with MAJ James Illingworth, USA, to create a virtual center for lessons learned in the acquisition process. The project is developing a central web-site for acquisition personnel to view past lessons learned in the acquisition process. The web-site will contribute to "organizational learning," thereby improving the acquisition process by identifying costly mistakes and providing positive guidance to practitioners currently conducting acquisition procedures. A secondary focus of this work will be the displaying of theses by acquisition students and possible theses topics identified by the acquisition community.

Professor **James Taylor** (Operations Research) is working with Capt Tanner to integrate rate based attrition algorithms found in current military simulations and emerging research in agent based simulation. They are exploring the relationship between human behavior and current rate based attrition algorithms and will then use an agent based architecture to model human decision making and behavior on the battlefield at individual and unit level.

Professor **Kevin Wood** (Operations Research) is working with LTC Jeffrey Appleget, USA, to develop enhanced solution techniques for solving integer programs (IPs) and mixed-integer programs (MIPs). They developed knapsack cut-finding procedures for minimal cover cuts, and converted existing cut-strengthening theory

into practical procedures that lift and tighten violated minimal cover valid inequalities to violated knapsack facets. They discovered a new class of knapsack cuts called "non-minimal cover cuts" and a method of lifting them called "deficit lifting." They plan to publish and present preliminary results, and to prove the robustness of their techniques by testing and extending their results to solve more difficult, real-world problems.

Associate Professor Man-Tak Shing (Computer Science) is supervising the thesis research of **Major Antonis Chalakatevakis**, Greek Army, for MAJ Jack Jackson, USA, of TRAC to re-engineer a legacy discussion war game used for resident and distance learning students at the Air Force War College. Under Professor Shing's supervision, an NPS student has analyzed the current program, designed an architecture and is now prototyping one component.

Professor **Morris D. Driels** (Mechanical Engineering) is working through TRAC-Monterey with Mr. Dave Dixon at TRAC-WSMR to improve algorithms that model the phenomena pertaining to the firsthand collection of battlefield information by an observer or sensor in combat models and simulations. The current research concerns infrared contrast signature modeling and the problem of edge detection by observers.

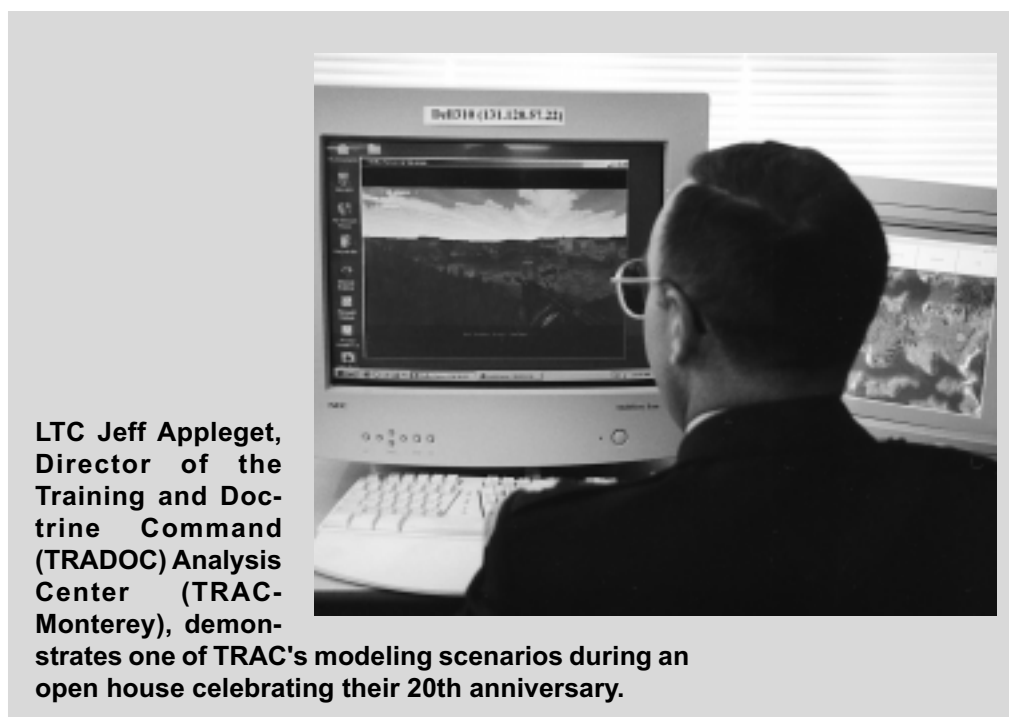

LTC Jeff Appleget, Director of the Training and Doctrine Command (TRADOC) Analysis Center (TRAC-Monterey), demonstrates one of TRAC's modeling scenarios during an open house celebrating their 20th anniversary.

RESEARCH CHAIRS

SUPPORT FOR 'CONRAD CHAIR' RENEWED

The Memorandum of Understanding establishing and supporting the Rear Admiral Peter C. Conrad Chair of Financial Management was renewed by the Naval Postgraduate School and the Office of the Assistant Secretary of the Navy (Financial Management and Comptroller). The incumbent of the Conrad Chair for the last five years, Senior Lecturer **John Mutty**, shared his experiences or "good fortune" as he put it, in this article.

The Conrad Chair was instituted to provide a direct link between the students and faculty of the Naval Postgraduate School and the Assistant Secretary of the Navy (Financial Management and Comptroller). Many leading civilian graduate schools of business invite experienced executives to serve, on campus, in the capacity of "Executive-in-Residence." That executive becomes a resident expert, thinker and transmitter of corporate lore and experience. He knows the workings of the administrative machinery as well as the strategies and tactics that keep it running. His task is to reflect on his experience and to assist both students and faculty through a variety of forums. Similarly, it was felt that it would be beneficial to have an individual on the NPS faculty who had experienced the world of DoD financial management "up close and personal." Few would disagree that there are frequently differences between the world of academia and the world of application, where personalities and politics can play

an exaggerated role. Professor Mutty's Navy experience in the Office of Budget and as Comptroller for the Naval Air Systems Command has allowed him to identify some of those differences and provide students with a feel for the financial management community they will soon experience.

A part of the Chair's charter is managing the Conrad Scholar Program. This is a program designed to identify the future leaders of the Navy's financial management community. Top students are identified as they are starting the thesis process. Their thesis topics are selected to address issues of importance to the Navy's financial management community and are approved by the program's sponsor, the Director of the Office of Budget. The students brief their theses to the sponsor and other interested members of the OPNAV and Secretariat staffs. Additionally, they write a publishable essay based on their theses. Several of these students have produced theses that have addressed some of the Navy's most vexing problems. For example, one student developed a forecasting methodology for estimating the environmental restoration costs associated with the Base Realignment and Closure (BRAC) process. His methodology noticeably outperformed the model that was being used by the Department of the Navy. Given the millions of dollars at stake, the better the estimates, the more likely that dollars will be budgeted and

--continued on page 31

The new Naval Space Systems Academic Chair, Charles Racoosin (second from left), was one of a group attending an open house for the Fleet Satellite Communications (FLTSATCOM) Laboratory at NPS. The open house was to celebrate a return to operation of the lab after several setbacks over the past few years, the most recent being a flood during early 1999.

NPS received the military qualified communications satellite designed and built by TRW nine years ago. The spacecraft was delivered with nine racks of electronic equipment that enabled staff to communicate and operate with it. Much of this technology was outdated and needed to be replaced. New software and hardware have been configured and live telemetry from the spacecraft was received, decoded and displayed on the VAX monitors during the open house. FLTSATCOM provides hands-on equipment for space operations and engineering students at NPS. Few universities have a military qualified communications satellite available for student training.

LT William K. Ham, USN, (June 2000) a thesis student of Professor Brij Agrawal (Aeronautics and Astronautics), Staff Engineer David Rigmaiden and Staff Computer Engineer Ed Nath played essential roles in making FLTSATCOM operational again.



RESEARCH CHAIRS

AVIATION SECURITY CHAIR ESTABLISHED AT NPS

A Memorandum of Understanding between the Naval Postgraduate School (NPS) and the Federal Aviation Administration (FAA), Office of Aviation Security Research and Development, formalized an agreement to establish the Aviation Security Chair at NPS. The NPS and FAA share common interests in conducting research and transferring technologies that relate to both military and commercial aviation. The FAA's Aviation Security Research and Development activity has been designated as the lead explosives detection agency for the federal government, except for the Department of Defense (DoD). The Navy has been designated as the lead for DoD agencies. Both the FAA and the Navy are concerned with enhancing the research and technology base needed to provide a safe, secure and efficient National Airspace System.

Both organizations have roles and missions that are supportive and complementary, with a strong potential for providing significant benefits from teaming, collaboration, and integration of some of their research activities.

The scope of the relevant technology is highly interdisciplinary, involving human factors in aviation, aircraft design and avionics, chemical, biological, and explosive detectors/sensors and threat assessment for terrorist attack. At NPS this breadth of knowledge is contained across several departments and academic groups: Aeronautics and Astronautics, Physics, National Security Affairs, Special Operations/Low-Intensity Conflict, and the School of Aviation Safety.

Dr. **James L. Fobes** has been appointed the first chairholder. Dr. Fobes recently served as the Human Factors Program Manager for Aviation Security at the FAA Technical Center. Previous experience includes positions with the U.S. Army Operational Test and Evaluation Command, U.S. Army Research Institute, and the California State University-Los Angeles.

NEW NAVAL SPACE SYSTEMS ACADEMIC CHAIR JOINS NPS

The Naval Space Systems Academic Chair was established by a Memorandum of Understanding between the Naval Postgraduate School (NPS) and the Naval Space Command. The Chair was established to provide direct interaction between the two agencies in order to promote and guide a focused instructional and research program in Space Systems at NPS which support all aspects of Naval space systems including education, research, development, procurement and operations.

Charles M. Racoosin joined NPS recently as the fifth incumbent of the Chair. A 1989 graduate of NPS with a M.S. in Astronautical Engineering, Mr. Racoosin has over twenty-two years of experience in space systems engineering, test and evaluation and acquisition, and collaborative decision support. Recent experience has been with the National Reconnaissance Office, the Naval Research Lab, Air Test and Evaluation Squadron ONE, and the Space and Naval Warfare Systems Command.

SUPPORT FOR 'CONRAD CHAIR' RENEWED, *continued from page 30*

spent where needed. Another student developed capacity utilization and productivity measurement methods for RDT&E laboratories. His methodology has been adopted by several of the Navy's major laboratories as an aid for their financial decision-making. Roughly 75% of the Conrad Scholars have had their essays published, providing excellent exposure for their research. Numerous requests for copies of their theses have resulted, thereby extending the reach of their research and its value to the Navy.

During the last five years, 18 students have been designated as Conrad Scholars. Professor Mutty expects to see them making the Navy's key financial decisions in the not to distant future.

As a further outlet for student research, the thesis abstracts for all Financial Management students have been published in the official professional journal for Department of the Navy financial operations specialists, the *Navy Comptroller*. This has resulted in requests for nearly 200 theses by Navy, DOD, and other organizations.

"Without question," Professor Mutty expressed, "my most lasting impression has been that of the enthusiasm, dedication, and interest of the 'typical' NPS student. The investment that the Navy is making in their education will be returned many-fold in the future."

Professor Mutty's successor, **VADM Paul F. McCarthy, USN (Ret.)** brings a wealth of experience in the fiscal management and budgetary fields from a long and extremely successful Navy career and as the Director of Naval Systems Integration for the Boeing Company. Professor Mutty expressed no doubt that the students and faculty at NPS will benefit from his insight, and "from experience, knows that he [VADM McCarthy], too, will also benefit greatly from the relationship."

CONFERENCES/SHORT COURSES

16TH ANNUAL REVIEW OF PROGRESS ON APPLIED COMPUTATIONAL ELECTROMAGNETICS

During March 2000, the Applied Computational Electromagnetics Society (ACES) held its 16th annual conference at the Naval Postgraduate School. ACES was formed in 1985 as a computer modeling electromagnetics (EM) workshop with the goal of providing a forum for the discussion of computer modeling tools like the Numerical Electromagnetics Code (NEC). Today, members of the society worldwide are very active in a wide range of Computational Electromagnetics (CEM) research and development, all of which are well represented at the annual conference.

The annual ACES conference provides an opportunity for CEM enthusiasts to gather together and share ideas and successes as well as failures concerning the practical application of computational methods to current EM challenges. Presentations, courses, and workshops are offered in areas such as the validation and performance of computer codes and the underlying solution techniques; the development of new algorithms, computational techniques, and code enhancements and the application of these techniques to real problems. In addition, ACES also addresses model input/output data issues, the intention being to provide some standard input geometry file and output format to ease the application of meshing routines and data management.

The ACES conference runs for six days. This year it was held from March 20 to 25. While Monday, Friday, and Saturday were reserved for full and half day short courses, the remaining conference days each began with a plenary session of general interest. After the plenary session the conference split into four parallel sessions, and provided the two hundred fifty attendees with papers on a wide range of topics. Many of those that attend this conference are from academia and government organizations; a smaller percentage is from industry.

This year's short courses addressed theoretical and numerical topics, and different design issues. A typical short course presented an overview of numerical techniques relevant to a particular type of computational electromagnetic modeling. In depth discussions on how to create and use effective models to solve a specific class of problems are included. Nearly all courses demonstrated the use of CEM tools. Four of the short courses were presented in the form of hands-on workshops by Research Associate Professor **Jovan Lebaric** of the Department of Electrical and Computer Engineering.

During the week, the major numerical techniques, their use, optimization and development were covered in a number of the sessions. For those actively involved in developing EM

modeling tools, these sessions provided good insight into the way the field is developing. It was also revealing to see how EM tools are applied to communication and military problems. Antenna behavior, radar cross-section and most other areas of CEM require great accuracy, while propagation modeling is somewhat less precise. It is encouraging to see that Computational Electromagnetic modeling can provide accurate answers to specific problems.

One area of interest that was particularly well attended concerns the "packaging" of electronic circuits for the newest PCs that are operating at speeds where electromagnetic effects begin to dominate the circuit layouts. The Electromagnetic Compatibility session addressed the difficulties associated with the creation of practical models for circuit packages and the use of transmission lines vs. conventional circuit wiring.

ACES is an excellent resource for those wishing to learn more about the application and the underlying theory of computational EM. Further information on ACES, including membership information, the call for papers for next year's conference, and contact information for ACES officers can be found at <http://aces.ee.olemiss.edu/>. This page also provides additional links to other computational electromagnetics pages that may be of interest. Research Associate Professor **Richard Adler** of the Department of Electrical and Computer Engineering has organized the conference and workshop for the past several years.

ENGINEERING APPROACHES FOR INFORMATION ASSURANCE: AN INTRODUCTION TO COMPUTER SECURITY

A one-week short course was taught by Lecturer **Daniel Warren**, Department of Computer Science, at the Space and Naval Warfare Systems Center-San Diego, from 24-28 April 2000. The course addressed the fundamental computer and network security issues of policy and assurance. It covered the technical issues of access control, intrusion detection systems, firewalls, cryptography, viruses, Trojan horses, and the Public Key Infrastructure (PKI) as well as the operational issues of system accreditation and system evaluation. The course stressed a systematic scientific and engineering approach to the topic and has been previously offered at NPS and on-site at the Defense Information Systems Agency in Arlington, VA.

CONFERENCES/SHORT COURSES

FOURTH INTERNATIONAL SYMPOSIUM ON TECHNOLOGY AND THE MINE PROBLEM

The Fourth International Symposium on Technology and the Mine Problem was held at NPS 12-16 March 2000. The theme of this Symposium was "Where We Are; Where We Are Going." Approximately 250 scientists, engineers, serving military, policy-level individuals, and members of the international "mine community" were in attendance including a delegation from Australia and representatives from Kuwait, Chad, and Singapore. Papers covered all aspects of the naval mine countermeasures/land countermine problem plus humanitarian demining and remediation of sites infested with unexploded ordnance. These latter aspects of the mine problem are technologically similar but qualitatively different and more challenging than the military mine clearance operations.

The Keynote Speaker was the Commandant of the Marine Corps, Gen James L. Jones, USMC. As Director of Expeditionary Warfare in the Navy and now as Commandant, Gen Jones has provided "hands on" oversight to the technological revolution in Mine Warfare. He warned against complacency as we continue to face daunting tasks in shallow water/surf zone regimes and in dealing with land mines. The entire student body of the Naval Postgraduate School was in attendance for the Commandant's address.

The senior representative of the U.S. Army was LTG Paul J. Kern, USA, Director of the Army Acquisition Corps. LTG Kern said, "Detection methods haven't changed much in 50 years. We are still sending men in with metal detectors, a slow and laborious process, and then sending someone else in to disarm it, blow it up, or dig it out." He then spoke to some of the technological initiatives from DARPA such as the use of unmanned aerial vehicles and the use of nuclear quadrupole resonance techniques that seem to be offering promise.

The Deputy Assistant Secretary of the Navy for Mine

Warfare and Explosives Ordnance Disposal, The Honorable Dale S. Gerry, was the Banquet Speaker. Mr. Gerry is seen as a powerful voice for mainstreaming mine warfare in the Navy, obtaining the synergism of complementary technologies, and of developing truly organic mine countermeasures capabilities while preserving the necessary dedicated platforms and personnel. Gerry expressed the impatience all feel at the glacial pace of development, test, modification, and test again.

The presentations of needs and requirements by the Commander of the Navy's Mine Warfare Command, RADM Jose Betancourt, USN, and by the Program Executive Officer, Mine Warfare, RADM Curt Kemp, USN, were responded to by Doug Todoroff of the Office of Naval Research who outlined the Navy's Future Naval Capabilities process and by a series of research and development plenary session presentations that were amplified by parallel technical sessions that went into technical detail at greater length. There were approximately 80 papers that will be published in the proceedings of the Symposium within a few weeks. The Symposium provided opportunity for aspects of the NPS

R&D activity in Mine Warfare to be showcased. Professor **Anthony Healey**, Department of Mechanical Engineering, reviewed the recent results of the NPS Autonomous Undersea Vehicle and the plans for participation in a Fleet Exercise in August. Two students of Visiting Professor **Tom Muir**, Department of Physics, presented results of their thesis work involving seismic technology for buried mine detection.

This Symposium Series and the Mine-related course and thesis work place NPS at the fore in supporting the Navy-Marine Corps Team in the quest for affordable operational solutions to the pressing problems presented by mines.

NPS TO OFFER SHORT COURSE ON THE SCIENCE AND TECHNOLOGY OF MINE WARFARE SYSTEMS

A direct outgrowth of the Symposium Series on TECHNOLOGY AND THE MINE PROBLEM, this course is open to all. The course will be taught at the advanced undergraduate level by a distinguished set of academicians and practitioners drawn from the NPS faculty and from the mine-research community at large. The course co-directors are **Albert M. Bottoms**, former NPS Chair of Mine Warfare, and Professor **Xavier Maruyama**, Department of Physics, and Dr. R. Norris Keeler, Chemical Engineer and Physicist and former Director of Navy Technology. The course is scheduled for 21-25 August 2000. Additional information can be found at www.demine.org.

CONFERENCES/SHORT COURSES

WORKSHOP ON REVISING THE ANTI-BALLISTIC MISSILE TREATY

On 18 May 2000, the USAF Institute for National Security Studies conducted a one-day workshop at the ANSER facility in Crystal City, VA. The purpose of the meeting was to offer a preliminary report on a multi-year project on National Missile Defense and the Anti-Ballistic Missile (ABM) Treaty being conducted by Associate Professor **James J. Wirtz** of the Department of National Security Affairs. The Workshop participants were supplied with alternative scenarios in which the ABM Treaty has undergone limited, moderate and extreme modification. Participants were asked to explore the political and strategic developments that are likely to follow in the wake of these changes. Participants also were asked to suggest policy options (arms control, deterrence, counterproliferation) to deal with the changes prompted by modification of the ABM Treaty and deployment of National Missile Defense. The project has attracted leading experts in the field: Dr. Jeffrey Larsen, Science Applications International Corporation; Dr. Kerry Kartchner, U.S. State Department; Dr. Robert Joseph, National Defense University; Dr. Richard Harknett, University of Cincinnati; Dr. Michael O'Hanlon, Brookings Institution; Dr. Bradley Roberts, Institute for Defense Analyses; Dr. Ivo Daalder, Brookings Institution; Dr. James Goldgeier, George Washington University; Dr. Timothy Hoyt, Georgetown University; Dr. Charles Ball, Lawrence Livermore National Laboratory; Dennis Ward, U.S. Senate; and Julian Schofield, Columbia University. The project has benefited from the support of several sponsors: The Defense Threat Reduction Agency, The Naval Treaty Implementation Office (SSP), and USAF XONP. Workshop participants are refining their analyses. Findings will be presented to sponsors and interested government officials in late summer 2000 and a revised report will be published sometime in the spring of 2001.

SECOND ANNUAL CLASSIFIED ADVANCED TECHNOLOGY UPDATE (CATU) COURSE

The U.S. Naval Postgraduate School held their Second Annual Classified Advanced Technology Update (CATU) short course from 28 February to 3 March 2000. The weeklong course was held at the TOP SECRET/SCI clearance level. The CATU was organized and managed by Ms. **Rita Painter**, the NPS/SPAWARSYSCEN Cryptologic Program Manager and facilitated by Professor **Herschel Loomis**, Department of Electrical and Computer Engineering, and Mr. **Vicente Garcia**, the National Security Agency Cryptologic Chair in residence at NPS. Thirty-five guest lecturers, selected based upon their renowned work and recognized subject matter knowledge, provided technical presentations on their area of expertise. Dr. William Perry, the former Secretary of Defense, and now a professor at Stanford University's Institute for International Security, was the keynote speaker. His presentation, "The Role of Technology in National Security," provided insight into the history of technology and how it has evolved in national security applications. Other technical topics presented included Cryptology, Information Operations, Overhead Reconnaissance, Digital Signal Processing, Communications, Low Probability of Intercept and Geolocation. Department of Defense forums such as these allow military and civilian technical personnel to stay current on the technological trends in the aforementioned areas. Approximately 200 representatives of various intelligence communities/functions/offices of the federal government, military services, and contractor elements were in attendance. The NPS venue provides an unbiased, unrestrained environment for all participants to freely discuss the research and development at their organizations and applications of those technologies in support of their missions. The next CATU has been tentatively scheduled for March 2001.

VIRTUAL EDUCATION AND THE FUTURE ROLE OF THE UNIVERSITY

The Naval Postgraduate School, together with the White House Office of Science and Technology Policy, will sponsor a conference on Virtual Education and the Future Role of the University scheduled for 8-9 August 2000 in Monterey. The purpose of the conference is to discuss the challenges and opportunities associated with the explosion of web-based learning and the impact on the future role of the university. Invited speakers include Michael T. Moe of Merrill Lynch, author of "The Book of Knowledge," a

financial report on investing in the growing education and training market, and Dr. James Duderstadt, President Emeritus of the University of Michigan, who will be speaking on "The Future of the University in an Age of Knowledge." The scheduled keynote speaker is Dr. Nishikant Sonwalker, Director of the Hypermedia Teaching Facility at the Massachusetts Institute of Technology. Additional information can be found at <http://web.nps.navy.mil/~code09/calendar.html>.

TECHNOLOGY TRANSFER

RECENT PATENT AWARDS TO NPS FACULTY

The intellectual property developed by NPS faculty can often lead to a patent. The Memorandum of Understanding initiated with the Federal Technology Center establishes a trial program to utilize the skills of FTC to market NPS intellectual property. NPS' latest patents were issued to Associate Professor **Phillip E. Pace** and Associate Professor **Douglas J. Fouts**, faculty in the Department of Electrical and Computer Engineering.

WIDEBAND UNDERSAMPLING DIGITAL RECEIVER: U.S. Patent Number 6,031,879 (P. E. Pace)

Abstract: An antenna receives an analog waveform and an analog signal indicative of the amplitude and frequency of the analog waveform. The analog signal is processed in a plurality of parallel digital processing channels each arranged to digitize the analog signal at a corresponding sampling frequency f_{si} to produce a plurality of digital signals. A discrete Fourier transform is applied to each of the digital signals output to produce a corresponding plurality of unique Fourier spectra of length $m_i = (f_{si})(T_{Li})$ where T_{Li} is the integration time for the discrete Fourier transform for each digital processing channel. The lengths of the Fourier spectra (m_i) are selected to be pairwise relatively prime. The discrete Fourier transform encodes the signals in same form as the symmetrical number system (SNS). A SNS-to-decimal algorithm is then applied to the detected bin values (a_i) to determine the numerical value of the frequency f of

the analog waveform. The receiver resolves all undersampling ambiguities exactly, thereby relaxing the speed requirements on the digital section of the receiver.

PREDICTIVE READ CACHE MEMORIES FOR REDUCING PRIMARY CACHE MISS LATENCY IN EMBEDDED MICROPROCESSOR SYSTEMS: U. S. Patent Number 6,047,359 (D. J. Fouts)

Abstract: A predictive read cache reduces primary cache miss latency in a microprocessor system that includes a microprocessor, a main memory and a primary cache memory connected between the main memory and the microprocessor via an instruction address bus, a data address bus and a data bus. The predictive read cache tracks the pattern of data read, addresses that cause misses in the primary cache, and associates the pattern with the specific instruction that generates the pattern of miss addresses. When a pattern has been determined, the address where the next cache data read miss will occur is predicted and sent to memory at a time when the memory is not busy with other transactions. The data at the predicted miss address is then fetched and stored in the predictive read cache. The next time a data read miss occurs in the primary cache, if the miss address matches one of the predicted miss addresses stored in the cache, then the required data is immediately sent to the primary cache from the predictive cache, rather than having to be read out of the much slower main memory.

TECHNOLOGY REVIEW AND UPDATE

The Seventeenth Technology Review and Update Course for Technical Personnel was held during the week of 24-28 April 2000. Professor **Rudolf Panholzer**, Dean of Science and Engineering and Chair of the Space Systems Academic Group, coordinated the course. Over fifty participants from DoD, academia and industry were in attendance. Presenters included Dr. Roger R. Schell, President, Secure Systems Solutions, on Internet Security—Opportunity or Oxymoron, Professor **John Powers**, NPS Department of Electrical and Computer Engineering, on Electro-Optical and Infrared Systems, Professor Richard M. White, University of California-Berkeley, on Micro Electro-Mechanical Systems

(MEMS), James Lenz, Honeywell, Inc., on Optical Sensing Technology, Peter Alfke, Xilinx, Inc., on Integrated Circuits, Austin Boyd, Science Applications International Corporation, on Military Satellite Communications Technology, Dr. James Stuart, Kitcomm, on Satellite Communication Technologies and Trends, and Dr. Hamid Berenji, Intelligent Inference Systems Corporation, on Computational Intelligence.

The course, intended for military and civilian technical personnel interested in refreshing and updating their knowledge, provides an excellent overview and stresses the more practical aspects of the technologies covered. The next TRAU is scheduled for 23-27 April 2001.

FACULTY NEWS

AERONAUTICS AND ASTRONAUTICS

S. K. Hebbbar, M. F. Platzer, and A. E. Fritzelas, "Reynolds Number Effects on the Vortical-Flow Structure Generated by a Double-Delta Wing," *Experiments in Fluids*, Vol. 28, No. 3, March 2000, pp. 206-216.

G. Hobson, S. Enomoto, and C. Hah, "Numerical and Experimental Investigation of Low Reynolds Number Effects on Laminar Flow Separation and Transition in a Cascade of Compressor Blades," 45th ASME International Gas Turbine and Aeroengine Technical Congress, Munich, Germany, May 2000.

G. Hobson and S. Weber, "Prediction of a Laminar Separation Bubble with Transition Over a Controlled-Diffusion Compressor Blade," 45th ASME International Gas Turbine and Aeroengine Technical Congress, Munich, Germany, May 2000.

M. F. Platzer and S. Weber, "A Navier-Stokes Analysis of the Stall Flutter Characteristics of the Buffum Cascade," ASME Paper 2000-GT-0385, International Gas Turbine Congress, Munich, Germany, 8-11 May 2000.

M. F. Platzer served as Chair of the Structures and Dynamics Committee at the International Gas Turbine Congress of the International Gas Turbine Committee. He also served as co-organizer (with Prof H. U. Meier of Germany) of the International Symposium on Viscous and Interactive Flow Field Effects, California State University-Long Beach, CA, 28 March 2000.

M. F. Platzer, "Transition and Turbulence Modeling for the Computation of Dynamic Airfoil Stall," International Symposium on Viscous and Interactive Flow Field Effects, California State University-Long Beach, CA, 28 March 2000.

M. F. Platzer presented invited

lectures on Flapping Wing Aerodynamics at the German Aerospace Research Center (DLR) in Goettingen, Germany, 4 May 2000, and at the Technical University of Braunschweig, Germany, 5 May 2000.

COMPUTER SCIENCE

C. Irvine, "Security Issues for Automated Information Systems," *Handbook of Public Information Systems*, ed., G. D. Garson, Marcel Dekker, Inc., New York, NY, pp 231-245.

C. Irvine and T. Levin, "The Effects of Security Choices and Limits in a Metacomputing Environment," NPS Technical Report, NPS-CS-00-004, April 2000.

C. Irvine and T. Levin, "An Introduction to Quality of Security Service," NPS Technical Report, NPS-CS-00-005, April 2000.

C. Irvine, H. J. Siegel, V. Prasanna, D. Hensgen, and T. Levin, "Management System for Heterogeneous Networks, Final Report, Volume I: Project Summary Papers," NPS Technical Report, NPS-CS-00-006, April 2000.

E. Spyropoulou, T. Levin, and C. Irvine, "Quality of Security Service Costing Demonstration for the MSHN Project," NPS Technical Report, NPS-CS-00-007, April 2000.

Jong-Kook Kim, D. Hensgen, T. Kidd, H. J. Siegel, D. St. John, C. Irvine, T. Levin, N. W. Porter, V. K. Prasanna, and R. F. Freund, "A QoS Performance Measure Framework for Distributed Heterogeneous Networks," *Proceedings, 8th Euromicro Workshop on Parallel and Distributed Processing*, Rhodos, Greece, January 2000.

C. Irvine and T. Levin, "Toward Quality of Security Service in a Resource Management System Benefit Function," *Proceedings of the 2000 Heterogeneous Computing Workshop*,

Cancun, Mexico, May 2000.

C. Irvine and T. Levin organized and chaired a panel session entitled, "Is Electronic Privacy Achievable?" at the IEEE Symposium on Security and Privacy, Oakland, CA, May 2000.

N. C. Rowe and R. S. Alexander, "Finding Optimal-Path Maps for Path Planning Across Weighted Regions," *International Journal of Robotics Research*, February 2000.

DEFENSE RESOURCE MANAGEMENT INSTITUTE

P. C. Frederiksen was invited to Supreme Defense Headquarters, Kingdom of Thailand, to present a brief on DRMI, NPS, and his research findings on the relationship between defense spending and economic growth. The presentation was hosted by LTGEN Kasemchart Naressenie, Director; MGEN Sompote Jindawattana, Deputy Director; and COL Chira Ketkasem, Director of Education and Training, Armed Forces Education Department.

ELECTRICAL AND COMPUTER ENGINEERING

J. T. Butler received the IEEE Third Centennial Medal for contributions to the IEEE Computer Society. Prof. Butler also received the IEEE Computer Society's Certificate of Appreciation for Service as a member of the Transactions Operations Committee.

D. J. Fouts passed the State of California Professional Engineer's exam and is now a Registered California Professional in Electrical Engineering.

P. E. Pace, D. Styer, and I. A. Akin, "A Folding ADC Preprocessing Architecture, Employing a Robust Symmetrical Number System with Gray-Code Properties," *IEEE Transactions on Circuits and Systems-II: Analog and Digital Signal Processing*, Vol. 47, No. 5,

-- continued on page 37

FACULTY NEWS

--continued from page 36

May 2000.

P. E. Pace and **D. J. Fouts**, "Digital Target Imaging Architecture for Multiple Large Target Generation," Office of Naval Research Electronic Warfare Science and Technology Gatherings, April 2000.

D. J. Wickersham, **P. E. Pace**, **D. Styer**, **D. C. Jenn**, **R. Vitale**, and **N. S. York**, "High-Resolution DF Architectures Using a Robust Symmetrical Number System Encoding," *Proceedings of the IEEE International Conference on Phased Array Systems and Technology*, MP3, Dana Point, CA, May 2000.

P. E. Pace organized and presented the advanced technical course, "Defense Technologies for the New Millennium," for the Swedish National Defence College (NDC), 20 March through 7 April 2000. This year marked the fourth annual course hosted by the NPS Center for Joint Services Electronic Warfare. NDC Commandant, Major General Karlis Neretneiks, and several officers from the Swedish Defence Headquarters participated in this course.

MECHANICAL ENGINEERING

A. Gopinath and **D. R. Harder**, "An Experimental Study of Heat Transfer from a Cylinder in Low-Amplitude Zero-Mean Oscillatory Flows," *International Journal of Heat and Mass Transfer*, Volume 43, pp. 505-520, April 2000.

T. R. McNelley and **M. T. Perez-Prado**, "Computer Simulation of Grain Boundary Character in a Superplastic Aluminum Alloy," *Superplasticity: Current Status and Future Potential*, P. Berbon, M. Z. Berbon, T. Sakuma, and T. G. Langdon, eds., *Materials Research*

Society Symposium Proceedings, Volume 601, April 2000, pp. 3-14.

T. R. McNelley, "The Application of EBSD Methods to Evaluate Grain Boundary Character of Fine-Grain Pure Aluminum," *Ultrafine Grain Materials*, R. S. Mishra, S. L. Semiatin, C. Suryanarayana, N. N. Thadhani, and T. C. Lowe, eds., The Materials Society, March 2000, pp. 185-194.

T. R. McNelley, "Processing, Recrystallization and Superplasticity in Aluminum Alloys," *Deformation, Processing and Properties of Structural Materials — A Symposium Honoring Professor Oleg D. Sherby*, E. M. Taleff, C. K. Syn, and D. R. Lesuer, eds., The Materials Society, March 2000, pp. 339-352.

T. R. McNelley and **M. T. Perez-Prado**, "Computer Simulation of Grain Boundary Character in a Superplastic Aluminum Alloy," Symposium on Superplasticity: Current Status and Future Potential, Fall 2000 Meeting of The Materials Research Society, Boston, MA, November 1999.

T. R. McNelley, "The Application of EBSD Methods to Evaluate Grain Boundary Character of Fine-Grain Pure Aluminum," Symposium on Ultrafine Grain Materials, 2000 Annual Meeting of The Materials Society, Nashville, TN, March 2000.

T. R. McNelley, "Processing, Recrystallization and Superplasticity in Aluminum Alloys," *Deformation, Processing and Properties of Structural Materials — A Symposium Honoring Professor Oleg D. Sherby*, 2000 Annual Meeting of The Materials Society, Nashville, TN, March 2000.

T. Sarpkaya, "Eulerian and Lagrangian Quantification of Sprays and Droplets," Annual ONR Meeting, California Institute of Technology, Pasadena, CA, 28 February through 3 March 2000.

T. Sarpkaya served as a member of the Export Advisory Panel of NAVSEA on the Hydrodynamics and Hydroacoustics of Submarines, held at the Naval Undersea Warfare Center, Washington, D.C., 10-14 April 2000.

T. Sarpkaya, "A New Model for Vortex Decay in the Atmosphere," *Journal of Aircraft*, Volume 37, No. 1, February 2000, pp. 53-61.

F. Novak and **T. Sarpkaya**, "Vortex Breakdown at High Reynolds Numbers," *Journal of the American Institute of Aeronautics and Astronautics*, Volume 38, No. 4, May 2000, pp 825-834.

METEOROLOGY

P. Durkee, **K. Nielsen**, and **LCDR G. Cooper**, USN, will participate in RIMPAC 2000 during June of this year. RIMPAC is a joint fleet exercise including many countries from the Pacific Rim. The NPS team will support the Naval Pacific Meteorology and Oceanography Center (NPMOC) at Pearl Harbor, HI, by implementing and testing new satellite remote sensing techniques in the context of operational requirements.

R. Haney and **A. Viudez**, "A Study of the Balance of Horizontal Momentum in a Vertical Shearing Current," *Journal of Physical Oceanography*, Volume 30, April 1999, pp. 573-589.

R. Haney, "Offshore Propagation of Eddy Kinetic Energy in the California Current," European Geophysical Society Meeting, Nice, France, May 2000.

NATIONAL SECURITY AFFAIRS

R. Looney, "Private Sector Investment in Pakistani Agriculture: The Role of Infrastructure Investment," *Journal of Developing Societies* (Leiden), Volume XV, No. 2, September 1999.

R. Looney, "Saudi Arabia: Measures

--continued on page 38

FACULTY NEWS

--continued from page 37

of Transition from a Rentier State," UCLA Conference on Iran, Iraq, and the Arab Gulf States, May 2000.

OCEANOGRAPHY

P. C. Chu and C. W. Fan, "Staggered Three-Point Combined Compact Difference Scheme," *Mathematical and Computer Modeling* (in press), 1999.

P. C. Chu, J. M. Veneziano, and C. W. Fan, "Response of the South China Sea to Tropical Cyclone Ernie, 1996," *Journal of Geophysical Research* (in press), 1999.

P. C. Chu, "P-Vector Spirals and Determination of Absolute Velocities," *Journal of Oceanography* (in press), 2000.

P. C. Chu, J. Lan, and C. W. Fan, "Japan/East Sea (JES) Circulation and Thermohaline Structure, Part 1 Climatology," *Journal of Physical Oceanography* (in press), 1999.

L. N. Ly and R. W. Garwood, "Numerical Modeling of Wave-Enhanced Turbulence in the Oceanic Upper Layer," *Journal of Oceanography* (in press), 2000.

L. N. Ly, W. P. Connor, and J. D. Paduan, "A Barotropic Simulation of Semi-Diurnal and Diurnal Tides for the Monterey Bay Region," *Coastal Dynamics and Estuaries in Hydraulic Engineering Software, VIII*, W. R. Blain, ed., Computational Mechanics Publications (in press), 2000.

P. Luong, C. P. Breshears, and L. N. Ly, "Dual-Level Parallelism Improves Load-Balance in Coastal Ocean Circulation Modeling," ERDC MSRC PET Technical Report, Vicksburg, MS, 23 pp.

L. N. Ly, "Using the Pivotal-Condensation Method in an Ocean Model with a New Surface Wave Parameterization," III Pan American Workshop in Applied and Computational Mathemat-

ics (invited), Trujillo, Peru, 24-28 April 2000.

A. Y. Benilov and L. N. Ly, "Modeling of Surface Waves Breaking Effects in the Ocean Surface Layer," III Pan American Workshop in Applied and Computational Mathematics, Trujillo, Peru, 24-28 April 2000.

L. N. Ly was invited to co-organize a mini-workshop on, "Ocean Modeling," at the III Pan American Workshop in Applied and Computational Mathematics, Trujillo, Peru, April 2000.

OPERATIONS RESEARCH

A. Buss, "A Framework for Component-Based Simulation Modeling," INFORMS 2000 Conference, Salt Lake City, UT, 7-10 May 2000.

A. Buss, "Using Servlets to Support Real-Time Decision Making Over a Wireless Network," INFORMS 2000 Conference, Salt Lake City, UT, 7-10 May 2000.

A. J. Ahumada and W. K. Krebs, "Signal Detection in Fixed Pattern Chromatic Noise," *Investigative Ophthalmology and Visual Science*, (Suppl) 41, 3796, Ft. Lauderdale, FL, 2000.

W. K. Krebs, E. A. Essock, S. E. Buttrey, M. J. Sinai, and J. S. McCarley, "An Oblique Effect of Chromatic Gratings Measured by Color Mixture Thresholds," *Perception*, in press.

S. M. Sanchez and P. Konana, "Efficient Data Allocation for Frequency Domain Experiments," *Operations Research Letters*, Volume 26, No. 2, March 2000, pp. 81-89.

S. M. Sanchez, "Internet Teaching: Interaction without Inundation," Issues in Education Column, *OR/MS Today*, April 2000.

S. M. Sanchez, "Robust System Selection," Spring 2000 INFORMS Meeting, Salt Lake City, UT, 7-10 May 2000.

S. M. Sanchez, "Fostering Active Learning in the Virtual Classroom," Teaching Effectiveness Colloquium, Salt Lake City, UT, 7-10 May 2000.

K. Wood, "Network Interdiction and Eavesdropping," Engineering-Economic Systems and Operations Research Colloquium, Stanford University, Palo Alto, CA, 9 May 2000.

PHYSICS

B. Denardo, "Nonradiation Wave Sources," Northern California/Nevada Section Meeting of the American Association of Physics Teachers, Stanford University, Palo Alto, CA, 7-8 April 2000.

Kinsler, Frey, Coppens, and J. Sanders, *Fundamentals of Acoustics*, John Wiley and Sons, 2000.

SYSTEMS MANAGEMENT

F. J. Barrett, "Multi-Party Collaboration as Transitional Space," S. Schruyer (ed), *Multi-Organizational Partnerships and Cooperative Strategy*, Tilburg University Press, 1999.

F. J. Barret, "Cultivating an Aesthetics of Unfolding: Jazz Improvisation as a Self-Organized System," S. Linstead and H. J. Hopfl (eds), *The Aesthetics of Organizations*, London Sage Press, 2000.

F. J. Barret, "Learning to Appreciate the Sublime: Don't Knock the Rock," R. Pellegrini and T. R. Sarbin (eds), *Between Fathers and Sons: Pivotal Narratives in Mens' Lives*, London Sage Press, 2000.

J. Ludima, D. Cooperrider, and F. J. Barret, "Appreciative Inquiry: The Power of the Unconditional Positive Question," P. Reason and H. Bradbury (eds), *Handbook of Action Research*, London Sage Press, 2000.

K. R. Gue, "A Dynamic Distribution Model for Combat Logistics," Naval

--continued on page 39

FACULTY NEWS

--continued from page 38

Postgraduate School, NPS-SM-99-003, December 1999.

K. R. Gue, "Data and Models to Build Supply Blocks for Deploying Marine Corps Units," Naval Postgraduate School, NPS-SM-99-005, December 1999.

D. R. Henderson, "Information Technology as a Universal Solvent for Removing State Stains," *The Independent Review*, Volume IV, No. 4, Spring 2000, pp. 517-524.

T. A. Hleba, "Practical Comptroller Course: Naval Postgraduate School Changes with the Times," *Navy Comptroller*, Volume XI, Issue I, FY2000.

S. O. Hocevar, "Preliminary Analysis of 1999 USMC Web-Based Exit Survey," Naval Postgraduate School, NPS-SM-00-001, January 2000.

S. Hocevar, "Inter-Unit Autonomy Versus Inter-Unit Coordination: Effects on Performance of Simulated Military Mission Accomplishment Under Two Conditions of Uncertainty," Annual Meeting of the Society of Industrial and Organizational Psychology.

L. R. Jones and Fred Thompson, "*Public Management: Institutional Renewal for the Twenty-First Century*," JAI Press, Inc., Stamford, CT, 1999.

M. Green, **L. R. Jones**, and F. Thompson, "Local Heroes: Reinvention Labs in the Department of Defense," J. L. Brudney, L. J. O'Toole, and H. G. Rainey (eds), *Advancing Public Management: New Developments in Theory, Methods, and Practice*, Washington, D.C., Georgetown University Press, 2000, pp. 153-172.

L. R. Jones and F. Thompson, "Strategic Public Management: Lessons for Public and Private Sector,"

Revista do Servico Publica, Escola Nacional de Administracao, Brasilia, Volume 25, No. 3, 2000

L. Jones, "Can Nations Save: Lessons from OECD Nations," 5th Annual Conference of the International Public Management Network (IPMN), Macquarie Graduate School of Management, Sydney, Australia, 5 March 2000.

M. E. Nissen, "Supply Chain Process and Agent Design for E-Commerce," *Proceedings of the Hawaii International Conference on System Sciences*, Maui, HI, January 2000.

M. E. Nissen, "Experimental Assessment of a Process Workflow Redesign Agent," *Proceedings of the Hawaii International Conference on System Sciences*, Maui, HI, January 2000.

M. E. Nissen, "A Multi-Agent Approach to Supply Chain Disintermediation," *Proceedings of the International Conference on Information Systems*, Charlotte, NC, Workshop on Information Technology and Systems, December 1999.

M. E. Nissen, "Knowledge-Based Knowledge Management in the Re-Engineering Domain," *Decision Support System*, 27, 1999, pp. 47-65.

M. E. Nissen, "SPS and Beyond: Innovating Acquisition through Intelligent Electronic Contracting," *Acquisition Review Quarterly*, Volume

6, No. 4, 1999, pp. 383-394.

M. E. Nissen, **M. N. Kamel**, and **K. C. Sengupta**, "Toward Integrating Knowledge Management, Processes and Systems: A Position Paper," *Proceedings of the American Association for Artificial Intelligence*, 2000 Spring Symposium, Stanford, CA, Workshop on Bringing Knowledge to Business Processes, March 2000, pp. 22-29.

N. C. Roberts, "Organizational Configurations: Four Approaches to Public Sector Management," J. L. Brudney, L. J. O'Toole, and H. G. Rainey (eds), *Advancing Public Management: New Developments in Theory, Methods, and Practice*, Washington, D.C., Georgetown University Press, 2000, pp. 217-234.

N. C. Roberts, "The Synoptic Model of Strategic Planning and the GPRA," *Public Productivity and*

Management Review, 23(3), 2000, pp. 297-311.

J. G. San Miguel, "A Comparison of Financial Disclosure Questionnaires for Federal Agencies," Naval Postgraduate School, NPS-SM-99-004, December 1999.

K. W. Thomas, *Intrinsic Motivation at Work: Building Energy and Commitment*, San Francisco Berrett-Koehler Publishers, Inc., 2000.

N. C. Roberts has received the "Frieder Naschold Award for Excellence in Scholarship, in the Field of Public Management" for the Best Paper of Conference at the 5th Annual Conference of the International Public Management Network at Macquarie Graduate School of Management, Sydney, Australia. In her paper entitled, "Coping with Wicked Problems," Roberts defined wicked problems as those where solutions seem virtually impossible, thus requiring cooperation and coordination between a large number of stakeholders and parties that is very difficult to achieve and where the human, social, and economic costs of inability to find resolutions, are very high.

FEATURED PROJECT

RAPID FLIGHT TEST PROTOTYPING SYSTEM, *continued from page 3*

Figure 4 illustrates the functional architecture of the trajectory tracking system. The trajectory tracking algorithm developed in [1] as well as the user interface and data conversion block were implemented on the ground station. During flight test the algorithm was asked to track a circle.

Figure 5 shows the projection onto the horizontal plane of the commanded trajectory as well as the actual trajectory of the Frog during flight test and simulation results. Clearly, the algorithm performed the tracking task well.

Conclusions

As a proof-of-concept demonstration, the RFTPS was used to take the trajectory tracking control concept presented in [1] and evaluate it in the environment for which it was designed. The project began with an unmanned air vehicle with unknown flight characteristics. In addition, a “black box” autopilot with unknown internal dynamics was placed onboard the vehicle. Through the use of the RFTPS, a high fidelity simulation of the vehicle and autopilot was built and used to synthesize the applicable control laws. Extensive testing in simulation followed and appropriate user interfaces were developed. Then, the RFTPS was used to control the vehicle in flight using the control laws developed, collect the data during the flight test, post process the data, and evaluate the performance of the algorithms.

The success of the project demonstrated both the utility of the trajectory tracking algorithm as well as the capabilities of the RFTPS. The trajectory tracking algorithm was shown to work well in a real world application. Performance in flight was very close to performance in simulation, which speaks well of the robustness properties of the algorithm. The RFTPS was shown to be powerful, portable, rugged, effective in the field and in the lab, and safe and reliable at controlling an aircraft.

References

[1] I. Kaminer, A. Pascoal, E. Hallberg and C. Silvestre, “Trajectory Tracking for Autonomous Vehicles: An Integrated

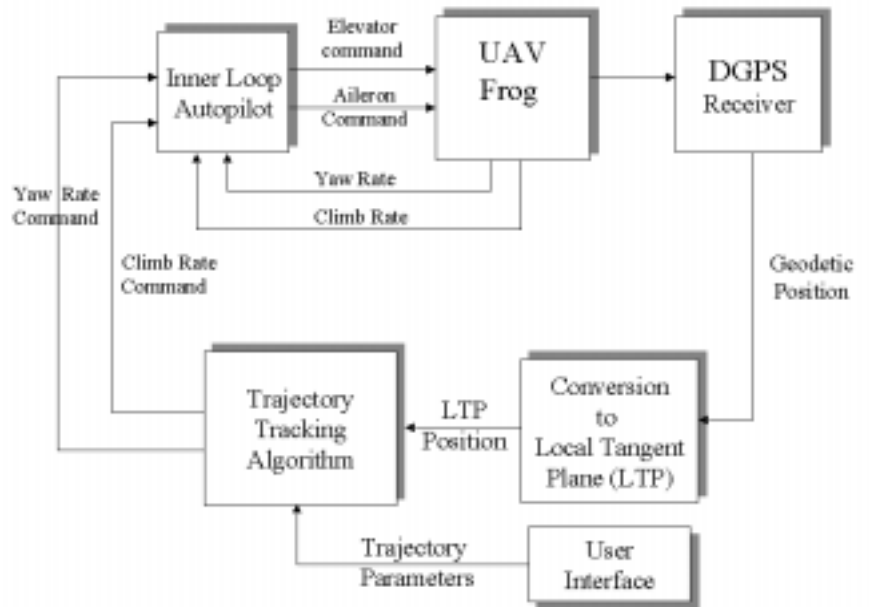

Figure 4. Functional Architecture of the Trajectory Tracking System

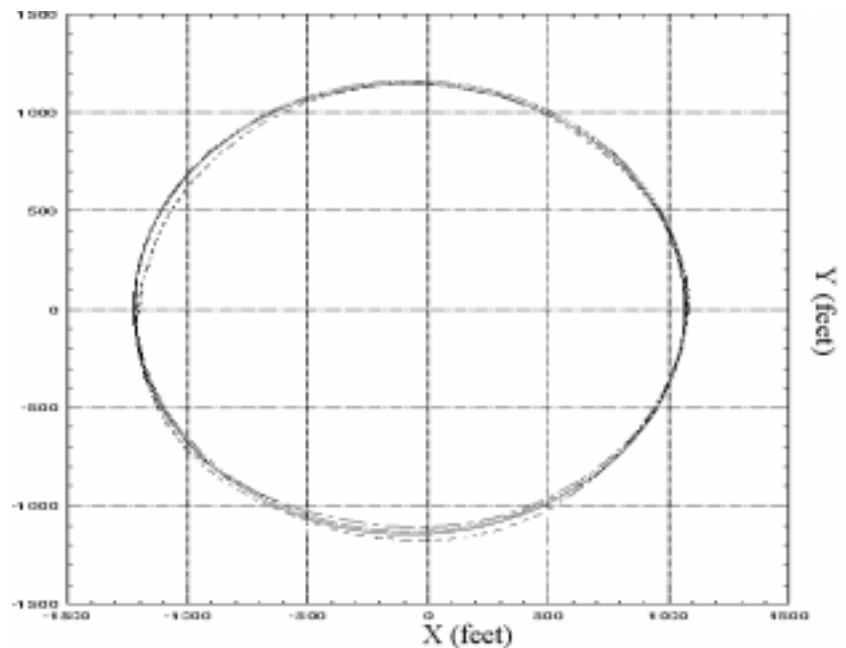

Figure 5. The autonomous flight of Frog--Projection onto the horizontal plane. Commanded trajectory is shown by the solid line. Frog’s flight path is shown by the dashed line. The results from simulation are shown as a dash-dot line.

Approach to Guidance and Control,” *AIAA Journal of Guidance, Control and Dynamics*, Vol. 21, No. 1, pp. 29-38, 1998.

FEATURED PROJECT

THE PLANNER'S DILEMMA, *continued from page 5*

Affairs (RMA). Amongst those efforts were a series of ten RMA Seminar War Games. The seminar games were organized, initially, to explore the impact that “new technology and systems derived therefrom” might have on our military organizations’ approach to the conducting of war. The players, military and civilians, were given a variety of stressing 2020 scenarios and a menu of choices, that is, they could choose say a satellite surveillance system, an arsenal ship and a energy beam air defense system, and then try to make use of the imputed capabilities. As the game series continued, the inputs from participants were used as the basis for a set of Navy Long Range Planning Objectives that began to define general capabilities that would be needed in 2020. However, there were two problems with the wargames and the objectives. First, intelligence could not provide any indication of the innovative path adversaries might take or how they might adapt technologies from the civilian world. And second, there was no apparent path from today’s systems and capabilities to those hypothesized for the year 2020. Absent a road map from today to 2020, which showed how the momentum of bureau activity would be dealt with, little credibility would be attached to these and similar RMA games by those dealing with the “real planning problems” of today.

In light of this “disconnect” between today and the year 2020, we devised our study to confront directly the issues that would have to be resolved to connect today with 2020. The vehicle has come to be known as the “Six Questions” and “Epoch Decision Days.” Since our concern was in creating credible trajectories for the evolution of “Area Denial” capability, we needed to show how the countries we selected for study would produce the needed force structure in the year 2020. We deliberately chose “real countries,” not pseudo-countries Orange, Green, Blue, because we wanted to deal with societal features, geography, and resources. It was not our goal to “project the future,” nor to identify potential adversaries, rather we wanted to construct logically consistent trajectories of force development for an expanding list of countries whose size and location would make them major players on the world scene. Our ideas owe a debt to the scenario approach to researching options described by Peter Schwartz in *The Art of the Long View: Planning for the Future in an Uncertain World*.

The 20 year period was broken into three Epochs, 2000-2006, 2007-2013, and 2014-2020. During Epoch I, 2000-2006, the students in each country team along with their faculty advisor documented what was currently in its “real order

of battle” using publicly available databases. For each country we assembled an outside group of experts to make decisions about Question One, Two and Three for the coming Epoch II, 2007-2013. For example, one country team had three students, a faculty advisor and a three member “Council of Holy Men.” The council members were a former Country Desk staff officer from the National Security Council 1975-1980, the former Chancellor of a University in the Middle East, and a renowned regional economist. Debate about one country, for example, was sparked by the recognition that their oil fields needed recapitalization. If they weren’t modernized then oil revenues could fall more than 30% over the time of Epoch II. Since the country couldn’t depend on foreign investment due to their international status, a choice to build an area denial capability meant even greater strain on their economy and the fortunes of the “Holy Men.” Thus, it was decided to shift foreign policy to become a place for investment, initiate R&D programs during Epoch II, and defer implementation of an “area denial” capability for consideration in Epoch III.

Listed below are the “six questions.” Obviously the U.S. team was not trying to build an area denial capability, rather it was charged to maintain the ability to project power in the face of determined opposition.

The Six Questions

- What is the expected threat to your territory and national interests, and what strategies, e.g., territorial or other ambitions, might you pursue that could generate a conflict or confrontation during this epoch or in the periods to come?
- What economic, foreign and military policies and programs do you choose to pursue for this Epoch?
- What is the projected size of your national economy for the years of this Epoch?
- How much of the national economy do you intend to spend on national defense during this Epoch? And, what fraction will go for the creation of the “Area Denial Force” or other military capability not currently found in your nations force structure?
- How much of the national defense expenditure will you allocate to each of the following resource allocation categories?
 - A. Current operations
 - B. Combat System Procurement
 - C. Intelligence

--continued on page 42

FEATURED PROJECT

THE PLANNER'S DILEMMA, *continued from page 41*

- D. Counterintelligence
- E. Research & Development
 - 1. Basic Research
 - 2. Specific capability development, e.g., high energy lasers
 - 3. Combat System Development to provide change in:
 - a. Area Coverage of the Combat System (Detection Engagement, Control, Command Subsystems)
 - b. Fire Power, number of targets engagable at a time
 - c. Responsiveness, time delay
 - d. Countermeasure susceptibility reduction
 - e. Availability of combat system, e.g., logistics, base structure.
- What is your resulting force structure anticipated for the end of the epoch, and what is your general operational concept for utilizing these forces in a conflict or confrontation? And, what are their projected combat capabilities characterized in terms of the five categories listed in the fifth question (E3), Combat System Development?

What Did We Learn?

First, we demonstrated that a set of twelve students, five faculty members, and a team of outside experts could in a two-quarter sequence of four-hour per week classes work through a complicated strategy and planning problem.

Second, mixing NPS students with various background experiences (USMC, USN, Canadian, USAF, USA) with former Congressmen, OSD senior staff, retired flag officers, analysts from the intelligence community, former presidents of research universities with wide ranging experience in R&D issues, faculty and staff from NPS and the Naval War College, and other world-class scientists and engineers informs the debate and brings credibility to the decisions that drive the results.

Third, the focus of the military on the "military option" is a largely foreign notion to many of our outside experts. At almost every turn there was a determined aversion to confronting and debating the consequences of the choice of particular military actions. Instead, there was a great tendency to push the discussions into the direction of diplomatic gambits and foreign policy choices and avoid the hard choices of having or not having a particular military force with specific military capabilities.

Fourth, our students learned that in the U.S. case the debate about our military and its "right sizing" and "right capability mix" is overlaid with uncertainty about the future. To illustrate, in our 1998 Area Denial study, country X was assumed

to have a rapidly growing GDP and a sizable fraction devoted to defense. (Their procurement budget equaled the U.S. DoD budget in 2010 and their total budget hit almost \$400B in purchasing power in 2020.) Yet, because of the way the Country X team allocated its budget, their army, fixed wing aircraft inventory, and naval craft in their navy fell in numbers as they modernized. Thus, from an "evidentiary intelligence" standpoint, the U.S. President, Congress and country saw a diminishing challenge to the U.S. military and kept DoD spending at 1.7% of GDP. However, by Epoch III Decision Day (2013), the intelligence information provided by our control group suggested that the Country X R&D program on ocean surveillance, cruise missiles, submarines, aircraft carriers, was beginning to produce a worrisome military capability. The response of the U.S. leadership group was to ramp up U.S. defense spending so that by 2020 it had grown to 5% of GDP.

Fifth, the Area Denial projects have prepared SSG Associate Fellows from NPS for effective participation in the SSG innovation efforts.

Sixth, the work of our Middle Eastern team provided a foundation for the design of a fleet battle experiment.

Seventh, our approach to defining future scenarios that are logically developed within geopolitical, economic and technological constraints has been shown to work.

What Next?

As pleased as we were with the efforts of the Area Denial study teams, our analysis just barely scratched the surface of the issues raised. Recognizing both the opportunities to do better and having experience with the limitations imposed by time constraints and the knowledge of the players, the NPS has developed a new professional military education curriculum that exploits the ONR/NPS/CEP experiment in force structure development. The Systems Engineering and Integration Curriculum was started 27 September 1999 with twelve officers. It is a novel curriculum at the NPS in both its organization, the first six months are taught with "block teaching" (one subject at a time for as much as two weeks), and in its use of "the problem" to form an integrative thread through the educational experience. Work on the SEI "problem" will be the sole activity during the last quarter of this six-quarter curriculum. From the work of the class and its faculty support will come a study result that describes the force development trajectories of three additional militaries, the Korean (assumed to reunite during this period), the Japanese, and the Australian over the period 2000-2020. Stay Tuned.

OPERATIONS RESEARCH CURRICULA, *continued from page 9*

for Vessels in a Formation: Tactical Vectoring Equipment.” LCDR Evanoff exploited inexpensive commercial off-the-shelf technology to reduce surface vessel collisions at sea. His visual navigation aid, a TVE display, will enhance shipboard conning officers situational awareness while maneuvering under low-illumination in battle group formation. The TVE will consist of six bi-color red and white lights spaced several feet apart mounted on the stern of an aircraft carrier, similar to the aviation runway displays used to assist pilots on final approach (Figure 1). LCDR Evanoff immersed subjects in a virtual environment to simulate a plane-guard operation. He found that surface warfare officers using the TVE display had fewer bearing and range errors than the normal carrier navigation light configuration while maintaining station 1750 astern of the carrier (Figure 2). The significant results gained

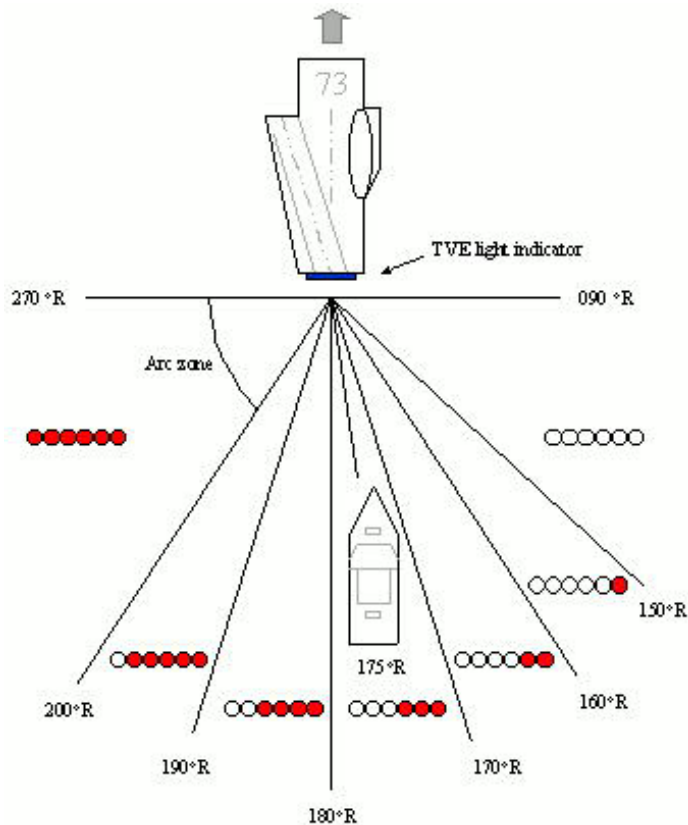

Figure 2. The red and white color system indicates the escort ship's relative position astern of the carrier. The desired station is 175° relative. As the ship's position changes relative to the carrier's stern, the light display changes color indicating approximate degrees off station. The conning officer can also interpret the aircraft carrier's range by the size and spacing of the lights from the combat vessel.

support from VADM Giffin (COMNAVSURFLANT), RADM Gemmill (CNO-N885), RADM Mullen (CNO-N86), and Office of Naval Research (Code 34) to fund a prototype. The land prototype should be ready for testing by June 2000. The FRS Helicopter Squadron HS-10 located at NAS North Island will assist with the land prototype testing to ensure that the display will be invisible to pilots while approaching the carrier. Once the land test is completed, the TVE display will be mounted on an AIRLANT carrier for sea trials later this summer.

In another project, Dr. Albert Ahumada, vision scientist at NASA Ames and NPS visiting professor, and Professor Krebs have been developing image discrimination models that can predict the detectability of target signals in color images. The results of the psychophysical studies may enable engineers to quantify an operators image-sensor-fusion detection performance, provide Operations Research analysts more accurate human detection thresholds for combat models, and gain better insight to the basic understanding of color perception.

Combat Models: The Value of Information in Conflict

The information age, like the industrial revolution before it, has the potential to transform the nature of military operations. The transformation may require dramatic changes in force structure, force organization, and tactics and doctrine. The challenge for defense analysts is to assist senior leadership in making the appropriate decisions. This task is complicated by a dearth of relevant real-world data and by difficulties in applying what we have learned from the past to the increasingly uncertain future. Consequently, combat simulation is an increasingly valuable tool for analysts, and hence decision-makers. Unfortunately, there is a lack of real combat data with which combat models can be validated, and furthermore, most combat models are very large and nonlinear. Therefore, it is difficult to fully explore them. To address these issues, Associate Professor **Tom Lucas'** research has explored: (1) using simple combat models and human experiments to assess the value of information in conflict; (2) using advanced statistical design of experiments to more efficiently search high-dimensional models; and (3) comparing and validating combat models and theory to historical combat data.

Simple combat models and controlled human experiments are used to assess the value of information in conflict and how that information is perceived by military decision-makers. In

--continued on page 44

RESEARCH AND EDUCATION

OPERATIONS RESEARCH CURRICULA, *continued from page 43*

a series of experiments involving 35 trials on each of 30 military and civilian DoD subjects, **LT John McGunnigle, USN** (September 1999) demonstrated that military decision-makers often do not use information optimally even in a simple stress-free situation. Equally insightful, the military decision-makers significantly overestimated the value of information compared to force advantage, suggesting that they too readily embrace the current enthusiasm for information technologies. Additional computational experiments on modern naval surface combat indicate that (1) increasing information advantage can enhance but occasionally may degrade a force's effectiveness, and (2) increasing force advantage in the same conflict always enhances the combat effectiveness of the forces investigated.

Statistical approaches that efficiently explore high-dimensional combat models with a variety of search strategies, such as full factorial, fractional factorial, Latin-hypercube, group screening searches, and combinations of these designs, are being examined. **Capt Lloyd Brown, USMC** (March 2000), also working with Professor Lucas, studied CNA's agent-based combat simulation Irreducible Semi-Autonomous Adaptive Combat (ISAAC) and found that fractional factorial designs provide almost as much information from ISAAC as full factorial designs with only a fraction of the simulation runs.

There is a dearth of detailed two-sided time-phased (daily) combat data that can be used to validate combat models and theories. Recently, the Dupuy Institute compiled detailed databases of the Battle of Kursk (the largest tank battle in history) and the Battle of the Bulge. **1st LT Turker Turkes, Turkish Army** (March 2000) examined how Lanchester equations and other forms fit the data. It turns out that a wide variety of models fit the data about as well--explaining conflicting findings in the literature. Unfortunately, none of the basic Lanchester models fit the data well, bringing into question their use in combat modeling.

The Battlespace/Information War (BAT/IW) Model and Analysis Tool

Modern military operations depend increasingly on the acquisition and usage of information concerning own, joint, and enemy force identities, locations, and apparent courses of action. The raw information (data) comes from a variety of sensors, and from other sources (SIGINT, ELINT); the products are digested, and that fused product informs decision-makers, who may choose to maneuver, dispatch appropriate weapons, or to seek further information. Weapon

dispatch is followed by effect appraisal; or battle damage assessment (BDA); this effort guides further action. A basic realism is that the data and subsequent actions are subject to errors that tend to degrade seriously system performance; the effects tend to be literally highly nonlinear. Thus the quality of information acquired and utilized can be of paramount importance to system operational success.

Distinguished Professor **Donald Gaver** and Professor **Patricia Jacobs** have constructed a dynamic aggregated model type for quickly analyzing military C4ISR systems that acquire information, process it with realistic time delays (latency), use it to direct actions (e.g. select and apply weapons to targets but the same issues arise in hazard relief and disaster control circumstances), infer the consequences of action (BDA), and repeat the process. The model is called Battlespace/Information War (BAT/IW). It realistically accounts for delays and uncertainties in enemy (and own) asset detection, classification, and weapon-target pairing effectiveness: the latencies and error rates characteristic of given system elements of systems-of-systems. It incorporates these system limitations into a high-level overall end-to-end scoping model that facilitates analysis of specific system sensitivities and opportunities for tradeoffs, where payoff is measured in terms of opponent kills (by type), exchange rates, campaign duration, the effects of platform sustainability, and weapons costs. The model emphasizes such issues as the degrading effects of either opponents incapability to identify false targets and decoys.

Development of BAT/IW has been sponsored by the Navy (N6C) and the model is currently being applied to better understand the effect of various system architectures and operational concepts in strike warfare, airborne electronic attack and suppression of enemy air defenses, and to analyze Network-Centric operational concepts.

OR Models and Algorithms Convert Real-Time Information into Decisions

Current military leaders are predicting a future battlefield that is much different than that of today. *Joint Vision 2010* and *Army Vision 2010* create a framework for planning a future force to succeed on that battlefield. Information superiority is the critical enabling technology that will allow U.S. forces to gain dominant battlefield awareness that will yield a much more accurate assessment of friendly and enemy operations. Current Army experiments include a computer in every

--continued on page 45

RESEARCH AND EDUCATION

OPERATIONS RESEARCH CURRICULA, *continued from page 44*

vehicle and even on every individual soldier. Operations research models and algorithms will be critically important in converting the glut of data into useful information for decision-makers. The thesis of **CPT Robert Bradford, USA** (June 2000), has designed an Architecture for Dynamic, Distributed Military OR (ADDMOR) to solve battlespace decision problems involving dynamic road networks using algorithms and data that are distributed over a dynamic, distributed computing network. This work is part of the Loosely Coupled Components faculty/student research group lead by Professor **Gordon Bradley** and Assistant Professor **Arnold Buss**.

The ADDMOR assumes that forces on the battlespace will be connected through a network of heterogeneous computing devices (for example, cell phones, personal digital assistants, personal computers, and super computers). This network will be changing as the forces move in the battlespace. The constantly changing data will be distributed across the network. The design is based on free, currently available technology including HTML servers to support Java servlets that will allow access to data, models and algorithms by any computer on the network that has an Internet browser. CPT Bradford demonstrated the architecture by constructing and testing a system to optimize the movement of personnel and materials on the battlespace road networks. The units in the battlespace are moving and the road network is changing as the battle unfolds. He demonstrated the capabilities of the system by constructing an application that would allow a medic to request directions to the nearest aid station. The request is submitted via a web page to an HTML server running a Java servlet that coordinates the construction of a solution. The servlet marshals the most current data on unit locations and road conditions (distributed across the computing network) and locates on the network an appropriate network optimization algorithm that is then used to construct a solution. The answer is returned to the medic in a web page that is appropriate for his computer (cell phone, personal digital assistant, computer, etc.). The ADDMOR is applicable to a wide range of other problems in warfare and operations other than war where the use of OR models and algorithms to convert real-time data into useful information for military decision-makers will contribute to better decisions.

Ranger Air Load Planner

The United States Army 75th Ranger Regiment conducts combat parachute operations as part of United States Special

Operations Command (USSOCOM). Currently the largest deployable asset of USSOCOM, the Rangers are required to plan and execute large-scale parachute assaults into hostile theaters with little or no notice. The thesis of **CPT Maximo A. Moore, USA** (June 2000), provides Ranger air load planners a tool to rapidly plan feasible equipment loads. The system is called the Java Ranger Air Load Planning Heuristic (JRALPH). JRALPH is simple to learn and operate, provides load solutions based on existing, United States Air Force approved load plans, and supports dynamic decision support with rapid solution return. The thesis, which was advised by Professor **Gordon Bradley**, also contains a mixed-integer programming optimization model used to validate JRALPH.

The success of any military tactical operation depends on preparation before attempted execution. The Rangers cannot rehearse movement from the landing site to the assembly area until the air load planner tells them in which aircraft they will be arriving at the objective area. Failure to generate a timely, robust load plan will result in wasted mission preparation time and possible mission failure. In September 1999, NPS faculty member **LTC Joel Parker, USA** and CPT Moore attended a Ranger training exercise where they observed a Ranger Battalion staff conduct air load planning. For the observed mission, the manual air load planning took one man 6-8 hours using a procedure that has not changed in 15 years. They met with various members of both the Regimental and Battalion staffs. These Rangers agreed that a planning assistance tool for air load planning would be welcome.

JRALPH presents the planner with an air load plan in a graphical user interface (GUI) that helps the planner visualize changes. JRALPH relieves the planner from tedious manual load planning and re-planning sessions required for final load plan approval by the Regimental Commander. During negotiations with subordinate unit commanders for load plan changes, the planner will be able to quickly assess the quality of their proposals; this is an automated capability that does not currently exist. JRALPH is written in the Java programming language. For a sample problem of a battalion-size operation with 11 different types of items and 11 aircraft, JRALPH explicitly evaluates over 16,000 individual load templates. JRALPH accomplishes this in less than one second on a contemporary personal computer. This thesis provides not only a demonstration of JRALPH's capabilities through a sample mission load plan, but also provides a

--continued on page 46

RESEARCH AND EDUCATION

OPERATIONS RESEARCH CURRICULA, *continued from page 45*

working product that can be adapted for use in air load mission planning by all units under USSOCOM.

Agent-Based Simulation Modeling

Urban warfare, information warfare, and operations other than war are a few of the important new concepts that concern military thinking. These new ideas require approaches to analysis that are different than those that have been traditionally conducted. DoD has relied on large simulation models to perform analysis on issues such as force structure, tactics, and doctrine. A new model that has emerged in recent years is based on autonomous, adaptive agents. Maj Ronald Woodaman, USMC (June 2000), working with Professor Gordon Bradley and Assistant Professor Arnold Buss, has developed a component framework for combining an agent-based approach with simulation modeling, building on the Simkit simulation package. Maj Woodaman is applying his framework to urban warfare scenarios that are of great interest to the Marine Corps. Combining simulation modeling with an agent-based approach stands to offer benefits available in both types of modeling.

The simulation models are based on a discrete-event

paradigm, in which events occur as particular epochs of simulated time. These events trigger a change of the systems state followed by further events being scheduled to take place in the future. The agent components consist of rules and meta-rules that describe how entities react to the state of the environment and of other agents. Each rule is relatively simple. The meta-rules are rules for how agents decide which rules are to be used in various situations. Adaptation is modeled by parameterizing the rules and the meta-rules. Together, the simple rules combine to produce complex behaviors from the simulation entities.

The agent-based approach is particularly useful for the urban scenarios studied in Maj Woodaman's thesis since they involve much smaller numbers of entities than traditional theater-level simulation models. Each unit's impact on the outcome is much greater. Information plays a much bigger role as well. Here, asymmetric information is modeled by each agent having its own perception of the state of the system (environment and other entities). Since each agent not only can have different sets of rules, but could have them respond differently due to adaptation, complexities can be captured in the model that would be difficult by any other means.

Senior Lecturer (emeritus) Wayne P. Hughes, Jr., (standing) formerly of the Department of Operations Research, was presented with the Department of the Navy Distinguished Civilian Service Award at his 70th Birthday Bash. The award is the highest honor bestowed upon a civilian by the United States Navy. "Professor Hughes has made significant and lasting contributions to education, analysis and innovation within the Navy during his tenure at NPS," the award reads in part. "He is widely recognized as one of the giants of Naval Operations Analysis, and has contributed extensively to its development. His critically acclaimed book, *Fleet Tactics: Theory and Practice*, now in its second edition, is the definitive work in analytical modeling of how naval units engage in combat." Professor Hughes has also served as NPS' first Chair of Tactical Analysis and as the Chair of Applied Systems Analysis.



RESEARCH LAB

RADAR AND EW LAB, *continued from page 11*

Figure 1) several agencies have expressed interest in working with us to study meteorological effects (e.g., National Oceanic Atmospheric Administration, National Center for Atmospheric Research, and the University of Massachusetts).

In addition, the Army is also supplying an S-band radar, the AN/TPQ-37 that will also be used for measuring weather effects with ONR and NAVSEA. A picture of the AN/TPQ-37 is shown in Figure 2. All of the radar in the Radar and EW laboratory (except for the SPS-40C) is authorized to free-space radiate. The ability to radiate is critical in any type of propagation experiment where target scattering effects are being measured.

Another recent acquisition is the AN/SLQ-32(V)2 that operates from 500MHz to 18.0 GHz and is used for electronic support and ship self defense. Its primary mission is to detect and identify (using threat libraries), incoming anti-ship cruise missiles and to subsequently transmit electronic jamming techniques in order to break the missiles track so that the missile misses the ship. Used onboard every ship in the Navy and many international ships as well, the SLQ-32 has a solid state IFM receiver and a Rotmen Lens antenna. A picture of the SLQ-32 is shown in Figure 3 below.

Computer Processing Laboratory

The Computer Processing Laboratory supports both classified (up to the SECRET level) and unclassified EW simulation and modeling.

--continued on page 48



Figure 2 (top). AN/TPQ-37 phased array radar.



Figure 3 (left). AN/SLQ-32 ship self-defense system.

RADAR AND EW LAB, *continued from page 47*

Classified Simulation and Modeling Tools: The classified simulation and modeling tools are described below. The classified simulation and modeling laboratory contains nine PCs and five Unix workstations.

- Improved Many on Many - The Improved Many on Many (IMOM) model is a program developed by the Air Force Information Warfare Center and used by the Air Force and Navy to graphically displays the electronic order of battle and provides threat detection analysis on various weapons and radar sites.

- Modeling System for Advanced Investigation of Countermeasures (MOSAIC) - The MOSAIC program was developed by the Air Force Wright Laboratory and grew out of the Advanced Strategic Tactical Expendables (ASTE) program. Used by the Air Force, Navy and industry, the MOSAIC program is capable of simulating laboratory experiments, field tests and live fire engagements between advanced infrared missiles and aircraft with modern infrared countermeasures.

- Digitally Integrated Modeling Environment (DIME) - The DIME program was developed by BDM (now TRW) and is used by both the Navy and the Air Force. The DIME program allows the analyst to visually display clutter maps, 3-D six degrees of freedom air vehicle flight paths and detection along a flight path. The end result is to determine the probability of kill either from the aircraft or missiles point of view.

- Georgia Tech Simulations Integrated Modeling System (GTSIMS) - The GTSIMS program was developed and is used by the Army. At present the program models a variety of electro-optical and infrared sensor and weapon systems, military vehicles and infrared countermeasure systems.

- Automatic Extraction of Threat Simulator Critical Parameters (AETSCP) - The AETSCP program was developed by the NPS Center for Joint Services EW and is used by the Naval Research Laboratory, Washington DC. The AETSCP is a Matlab toolbox that extracts the electronic warfare integrated reprogrammable database (EWIRDB) parameters from an anti-ship cruise missile hardware-in-the-loop simulator using the results from a battery of ASCM characterization tests originated in the NRL Central Targeting Simulation (CTS) facility.

- Central Targeting Simulation View (CTSView) - The CTSView program was developed by the NPS Center for Joint Services EW and is used by the Naval Research Laboratory. CTSView is a graphical user interface and model development tool used to evaluate the performance of various

anti-ship cruise missile (ASCM) platforms. The CTSView utilizes both hardware-in-the-loop experimental data and P-3 ORION field-test data to visually analyze, model and predict the effectiveness of the ASCM platforms against shipboard electronic attack.

- Centralized Relative Targeting Software Architecture (CRTSA) - The Centralized Relative Targeting Software Architecture was developed by the NPS Center for Joint Services Electronic Warfare and is used by the Naval Research Laboratory. The CRTSA displays captive-carry HIL missile simulator test range results in geodetic coordinates using only the sensors available on board the captive-carry platform (GPS, INS, seekers). Along with deriving the targets coordinates, a track-tagging algorithm is also presented to identify the true target using the drift angle from the INS.

- Airborne Reactive Electronic Warfare Simulation (ARES) - The ARES simulation was developed by the Naval Research Laboratory and is being used to quantify the Analysis of Alternatives (AoA) for the replacement of the EA-6B Prowler. The laboratory provides the environment necessary for the students to conduct a series of network-centric exercises to develop and analyze detailed operational concepts for a distributed network of electronic attack and electronic support systems for several important information operations.

Unclassified Simulation and Modeling Tools: The unclassified laboratory is supported by the Naval Research Laboratory and provides an environment for investigating both network-centric radar EW and anti-ship cruise missile defense at the unclassified level.

The network-centric radar EW software allows the student to investigate the data link requirements for several important combat scenarios using an Airborne Reactive Electronic Warfare Simulation (ARES). The software provides the environment necessary for the students to conduct a series of exercises to develop and analyze detailed operational concepts for a distributed network of electronic attack and electronic support systems for several important information operations.

The anti-ship cruise missile simulation model allows the student to analyze the effects of ship maneuvers and off-board decoy repeaters on the miss distance of the missile. Students are able to design their own anti-ship cruise missile and also design their own shipboard repeater decoy and tactics. Simulation results can be easily obtained to quantify the effectiveness of the decoy tactics in making the missile miss the ship.

PROJECT NOTES

WIRELESS NETWORKS, *continued from page 21*

and aid organizations. Wireless communications seem like an obvious solution in situations such as the recent floods in Africa. Computing and networking can still be used even if wired telecommunications infrastructures have been damaged. If networking is based on IEEE802.11 protocols, the communications will work regardless of what computing platforms other agencies are using.

Campus Infrastructure

The LCC Working Group has been actively working to create an infrastructure for wireless networking which will eventually give users connectivity from any building (See Figure 3). Campus Networking has committed a significant portion of a

Class C network for this purpose. This network, 131.120.14.*, provides the wired backbone for the wireless network. Wireless access points connected to this backbone provide connectivity to a common DHCP server, which allocates IP (Internet Protocol) addresses to the wireless clients. Since the DHCP server is common across the backbone, the leased IP address is valid for all access points along this subnet. The initial implementation was completed early this year on the second floor of Glasgow Hall. Students have found it particularly useful to be able to work from their study desks.

Campus network services can convert any specified ethernet port to be part of this effort. Once the ethernet port has been

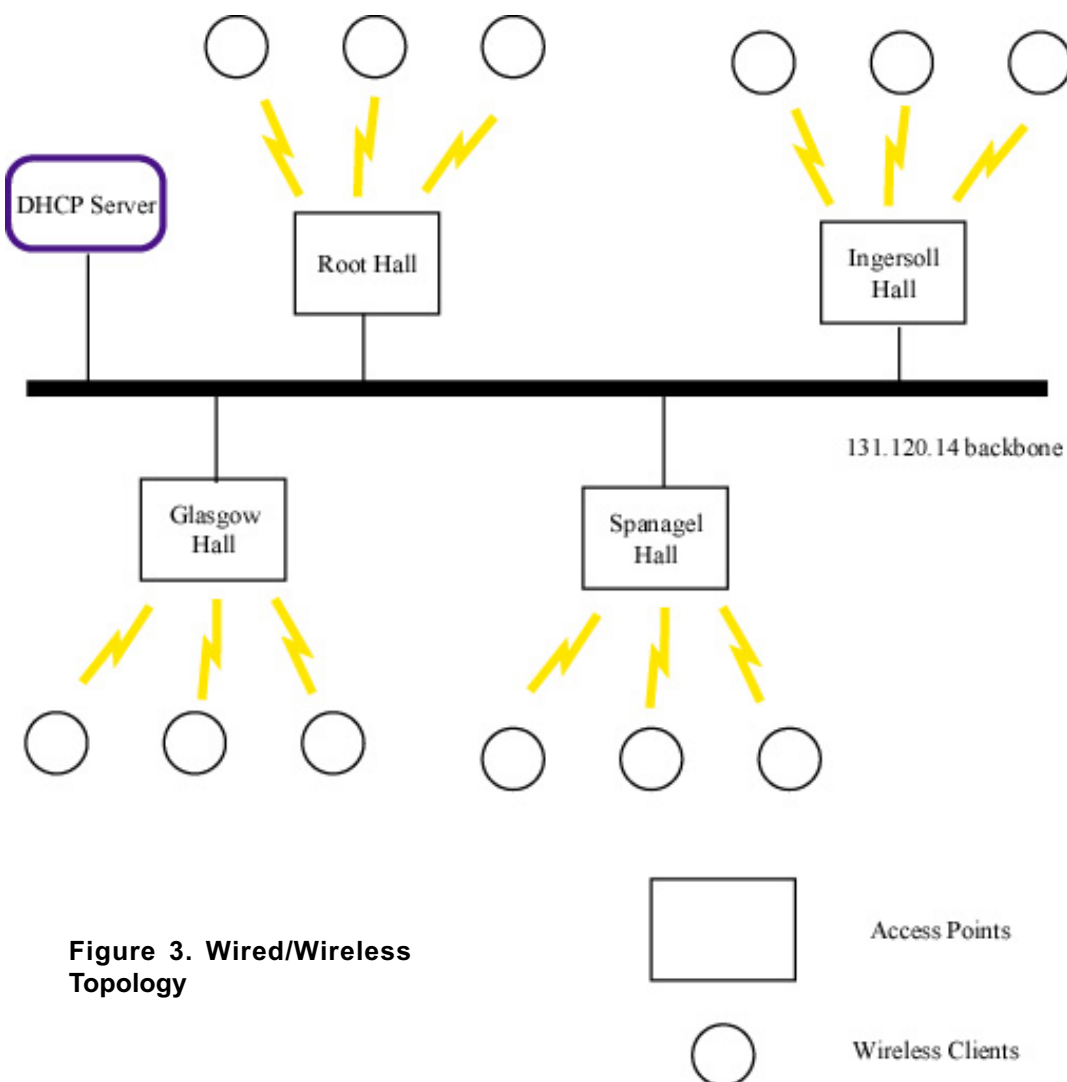

switched to the common backbone, an access point of some sort needs to be connected. As mentioned earlier, we have found both Linux and Apple Airports to be cost-effective solutions. Finally, all of the client computers need to be configured with the shared network password, and to use DHCP. With a minimal investment of resources – an ethernet port dedicated to the wireless subnet and corresponding access point approximately every 200 feet – it would be possible to enable the entire campus for wireless networking.

Application

CPT Maximo Moore, USA, a student in the Operations Research Department and part of the LCC Working Group, has applied the LCC architecture running on a wireless network to Ranger Deployment Airfield Control Operations (DACO). The problem is to keep track of

--continued on page 50

PROJECT NOTES

WIRELESS NETWORKS, *continued from page 49*

personnel and equipment during a DACO. This is particularly important during the exfiltration part of the operation, where it is critical to identify soldiers or equipment that may have been loaded on different helicopters than they came in on.

CPT Moore developed a web-based wireless network solution using notebook computers. One laptop is designated a "server" – it must be running a database and web server application. The rest of the system is comprised of client laptops with barcode scanners and web browsers. Each soldier and piece of equipment will have a bar code that is scanned by a client laptop whenever he gets on or off any aircraft. The database containing information on where everyone (and everything) is located is updated wirelessly via a "servlet," a small application that is accessed using a standard web browser. The servlet can also ascertain the status of any individual or item of equipment. Servlets use standard HTML without any special requirements. Therefore, any device that is wireless-capable, authenticated to the network, and can run a browser can access the database using servlets.

This application illustrates the utility of the "LAN in a Bag" design. Deployment involves configuring all devices to a common network password, and then bringing the server and one or more clients within range of each other. The equipment is extremely portable, involves only COTS technologies, and the network that is the underpinning is completely transient and dynamic.

Other Uses

The LCC Working Group's wireless architecture was utilized recently by the Center for Executive Education (CEE) in a three-week course for high-ranking flag officers. The concept was that the participants could either bring their notebook computers and be issued a wireless card or use one of the Center's notebook computers for the course's computing requirements. The wireless computers were critical to the conduct of the module. For example, small breakout groups had complete internet access no matter where they met within the Center. All participants were able to communicate with each other and share documents on the computers.

The network also illustrated the wired/wireless concept as well as mixed network ideas. In order to obtain internet access, both a WavePoint and an AirPort hub were used. Connectivity was seamless, and the users were unaware of which access point was being used at any time. Furthermore,

an old 486 computer was rescued from excess and configured with the Linux operating system to issue IP addresses using DHCP. When a wireless notebook was turned on and the card inserted, it issued a request for an IP address that went onto the wired LAN from either the AirPort or the WavePoint hub. This request was captured by the 486 Linux machine, which issued the address. From that point on the client had full IP networking, including internet access.

Ongoing Work

The LCC Working Group is continuing to work on various ways that new and emerging computing technologies can best be exploited to improve military planning and decision-making. The focus is on how these technologies can be best exploited to improve military planning and decision-making using tools from Operations Research and the Decision Sciences.

The research has been sponsored by grants from the Air Force Office of Scientific Research (AFOSR), NPS' Institute for Joint Warfare Analysis (IJWA), Office of Naval Research (ONR), and USSOCOM.

References

- [1] Bilyeu, Allan L., "Concept for a Special Operations Planning and Analysis System," MS in Operations Research, June 1998.
- [2] Bradford Robert, "Solving Dynamic Battlespace Movement Problems Using Dynamic Distributed Computer Networks," MS in Operations Research, June 2000.
- [3] Curley, PH2 Larry, "Wireless LAN Soars Through the Clouds," *Campus News*, September 16, 1999.
- [4] Moriarty, Sean T., "A Technical Demonstration of a Map Based Logistics Planning Tool," MS in Operations Research, September 1997.
- [5] Moss, Robert B., "SOF Tactical Intranet : Low Probability of Detection, Low Probability of Exploitation Communications for Special Operations Forces, Using A Commercial Off The Shelf Wireless Local Area Network," M.S. in Systems Technology and M.S. in Defense Analysis, September 1999.
- [6] Tripp, Stephen J., "An Airborne High Data Rate and Low Cost Digital Communications Network Using Commercial Off The Shelf Wireless Local Area Network Components," M.S. in Systems Engineering, September 1999.

CONFERENCE CALENDAR

CONFERENCES/MEETINGS AT THE NAVAL POSTGRADUATE SCHOOL

Date	Title	Sponsor
5-9 Jun 00	2000 National Operations Security Conference and Exhibition (SECRET sessions)	National Security Agency, Interagency Operations Security (OPSEC) Support Staff
6-8 Jun 00	International Technical Exchange Meeting on Navy Fuels, Lubricants and Allied Products	Naval Sea Systems Command
20-22 Jun 00	Joint Theatre Level Simulation (JTLS) Configuration Control Board Conference	Joint Warfare Fighting Center
23-24 Jun 00	35th Annual Colonel Allyn D. Burke Memorial Dental Symposium (UNCLAS)	NPS Dental Clinic
24-28 Jun 00	Air Directorate Field Advisory Council (ADFAC) Meeting	California Air National Guard
25-28 Jun 00	Command and Control Research and Technology Symposium	Office of the Assistant Secretary of Defense
27-28 June 00	Globalization and Security: An Executive Forum	Under Secretary of the Navy
29-30 Jun 00	Command Control Communications SNR COE Working Group Meeting	U.S. Mission to NATO and Defense Information Systems Agency
8-9 Aug 00	Virtual Education and the Future Role of the University	White House Office of Science and Technology Policy and the Naval Postgraduate School
21-25 Aug 00	Science and Technology of Mine Warfare Systems Short Course	Naval Postgraduate School
26-28 Sep 00	INTELINK Annual Conference	Defense Analysis Intelligence Center
7-10 Nov 00	AIAA 2000 Missile Sciences Conference (SECRET)	American Institute of Aeronautics and Astronautics
13-16 Nov 00	Aircraft Survivability 2000; Science and Technology Initiatives Symposium	Air Force Research Lab
13-17 Nov 00	2000 JANNAF CS/APS/PSHA Joint Meeting	JANNAF Interagency Propulsion Committee

NPS has excellent facilities for hosting conferences, workshops, symposia, and meetings. The wide range of facilities can accommodate both small and large groups. Additional rooms are available for smaller functions or breakout sessions. Conferences classified through SECRET can be accommodated on the NPS campus. Sensitive Compartmented Information Facility (SCIF) facilities exist and may be available for small groups on a more restricted basis. For more information, contact the NPS Conference Coordinator, Eileen Hamilton, at 831-656-2426 or by e-mail, eehamilt@nps.navy.mil.

RESEARCH DIRECTORIES

RESEARCH OFFICE

Associate Provost and Dean of Research

David W. Netzer Code: 09
Phone: 831-656-3241
Mail: dnetzer@nps.navy.mil

Director of Research Administration

Danielle Kuska Code: 91
Phone: 831-656-2099
Mail: dkuska@nps.navy.mil
research@nps.navy.mil

Research Programs/Publications

Judy Joyce Code: 91JJ
Phone: 831-656-2098
Mail: jjoyce@nps.navy.mil

Administrative Support Assistant

Dolores Jackson Code: 91DJ
Phone: 831-656-2098
Mail: djackson@nps.navy.mil

Conference Coordinator

Eileen Hamilton Code: 92
Phone: 831-656-2426
Mail: eehamilt@nps.navy.mil

Research Support Services

Teri Jay Code: 91TJ
Phone: 831-656-1044
Mail: tjay@nps.navy.mil

Research Financial Analysts (Sponsored Programs)

Laura Ann Small Code: 91LS
Phone: 831-656-2271
Mail: lsmall@nps.navy.mil
Sandra Key Code: 92SK
Phone: 831-656-2272
Mail: skey@nps.navy.mil

Research Administration Assistant (Publication Page Charges, Technical Reports/Assistant Thesis Processor)

Nenita Maniego Code: 91NM
Phone: 831-656-2273/2762
Mail: nmaniego@nps.navy.mil

Thesis Processor

Elaine Christian Code: 91EC
Phone: 831-656-1124
Mail: echristian@nps.navy.mil

RESEARCH CENTERS

Center for Autonomous Underwater Vehicle (AUV) Research
Professor Anthony Healey, Director

Center for Civil Military Relations
Associate Professor Paul Stockton, Director

Center for Diversity Analysis
Professor George Thomas, Director

Center for INFOSEC (Information Systems Security) Studies and Research
Assistant Professor Cynthia Irvine

Center for Interdisciplinary Remotely Piloted Aircraft Studies (CIRPAS)
Distinguished Professor David W. Netzer, Executive Director

Center for Joint Services Electronic Warfare Simulation and Modeling
Associate Professor Phillip Pace, Director

Center for Material Sciences and Engineering
Professor Alan Fox, Director

Center for MASINT Research
Lyle Ashton Cox, MASINT Chair Professor and Director

Center for Reconnaissance Research
Professor John P. Powers, Director

Center for Recruiting Innovation
Professor Mark Eitelberg, Director

Center for Signal Processing
Professor Charles Therrien, Director

Cryptologic Research Center
Vicente Garcia, National Security Agency Cryptologic Chair and Director

Decision and Information Systems Center
Associate Professor Hemant Bhargava, Director

Institute for Joint Warfare Analysis (IJWA)
Professor Gordon Schacher, Director

Joint Center for International and Security Studies (JCISS)
Research Associate Professor Jan Breemer, Director

Navy-NASA Joint Institute of Aeronautics
Distinguished Professor Max Platzer, Director

Research Center for Military Applications of Space
Alan Ross, Navy TENCAP Chair and Director

Software Metrics Center
Professor Norman Schneidewind, Director

Spacecraft Research and Design Center
Professor Brij Agrawal, Director

Turbo-Propulsion Laboratory
Professor Ray Shreeve, Director

Vertical Flight Technology Center
Professor E. Roberts Wood, Director

Comments/inquiries regarding *Research News* can be addressed via e-mail to: research@nps.navy.mil. Additional information about *Research at NPS* can be found at <http://web.nps.navy.mil/~code09/>