



Author(s)	Nugent, Devon Courtney
Title	Analysis of FOVEON multi spectral sensor for counter camouflage, concealment and deception applications
Publisher	Monterey California. Naval Postgraduate School
Issue Date	2005 12
URL	http://hdl.handle.net/10945/1755

This document was downloaded on May 04, 2015 at 23:44:52



<http://www.nps.edu/library>

Calhoun is a project of the Dudley Knox Library at NPS, furthering the precepts and goals of open government and government transparency. All information contained herein has been approved for release by the NPS Public Affairs Officer.

**Dudley Knox Library / Naval Postgraduate School
411 Dyer Road / 1 University Circle
Monterey, California USA 93943**



<http://www.nps.edu/>



**NAVAL
POSTGRADUATE
SCHOOL**

MONTEREY, CALIFORNIA

THESIS

**ANALYSIS OF FOVEON MULTI-SPECTRAL SENSOR FOR
COUNTER-CAMOUFLAGE, CONCEALMENT AND DECEPTION
APPLICATIONS**

by

Devon Courtney Nugent

December 2005

Thesis Advisor:

Richard C. Olsen

Co-Advisor:

Gamani Karunasiri

Approved for public release; distribution is unlimited

THIS PAGE INTENTIONALLY LEFT BLANK

REPORT DOCUMENTATION PAGE			<i>Form Approved OMB No. 0704-0188</i>
Public reporting burden for this collection of information is estimated to average 1 hour per response, including the time for reviewing instruction, searching existing data sources, gathering and maintaining the data needed, and completing and reviewing the collection of information. Send comments regarding this burden estimate or any other aspect of this collection of information, including suggestions for reducing this burden, to Washington headquarters Services, Directorate for Information Operations and Reports, 1215 Jefferson Davis Highway, Suite 1204, Arlington, VA 22202-4302, and to the Office of Management and Budget, Paperwork Reduction Project (0704-0188) Washington DC 20503.			
1. AGENCY USE ONLY (Leave blank)	2. REPORT DATE December 2005	3. REPORT TYPE AND DATES COVERED Master's Thesis	
4. TITLE AND SUBTITLE: Analysis of FOVEON Multi-Spectral Sensor for Counter-Camouflage, Concealment and Deception Applications			5. FUNDING NUMBERS
6. AUTHOR(S) Devon Courtney Nugent			
7. PERFORMING ORGANIZATION NAME(S) AND ADDRESS(ES) Naval Postgraduate School Monterey, CA 93943-5000			8. PERFORMING ORGANIZATION REPORT NUMBER
9. SPONSORING /MONITORING AGENCY NAME(S) AND ADDRESS(ES) N/A			10. SPONSORING/MONITORING AGENCY REPORT NUMBER
11. SUPPLEMENTARY NOTES The views expressed in this thesis are those of the author and do not reflect the official policy or position of the Department of Defense or the U.S. Government.			
12a. DISTRIBUTION / AVAILABILITY STATEMENT Approved for public release; distribution is unlimited			12b. DISTRIBUTION CODE
13. ABSTRACT (maximum 200 words) The research described here addresses a technology that may be useful for the defeat of camouflage, concealment, and deception (CC&D). This research aims to study a low cost and highly portable alternative to existing counter CC&D techniques. A commercial off the shelf (COTS) imagery sensor able to distinguish near-infrared (NIR), near-ultraviolet (NUV), and visible wavelengths has been studied. The FOVEON image sensor, a multi-layer focal plane technology, was used in a simple camera implementation to test its viability as a multispectral imager. As expected the sensor functioned as both a visible and NIR detector. Vegetation was easily distinguished based on its NIR reflectance, and man-made materials could be effectively separated from the background			
14. SUBJECT TERMS Photodetector, FOVEON, Responsivity, Digital Imagery, Digital Imagery Processing, Digital Imagery Analysis, NIR Imagery, Camouflage, Concealment, Deception, CC&D, Counter-CC&D, Foliage Penetrating Radar, FOPEN, Laser Radar, LADAR, Hyper-spectral Imagery, Multi-spectral Imagery			15. NUMBER OF PAGES 67
			16. PRICE CODE
17. SECURITY CLASSIFICATION OF REPORT Unclassified	18. SECURITY CLASSIFICATION OF THIS PAGE Unclassified	19. SECURITY CLASSIFICATION OF ABSTRACT Unclassified	20. LIMITATION OF ABSTRACT UL

THIS PAGE INTENTIONALLY LEFT BLANK

Approved for public release; distribution is unlimited

ANALYSIS OF FOVEON MULTI-SPECTRAL IMAGES FOR COUNTER-CAMOUFLAGE, CONCEALMENT AND DECEPTION APPLICATIONS

Devon C. Nugent
Lieutenant Commander, United States Navy
B.T., Pratt Institute, 1989

Submitted in partial fulfillment of the
requirements for the degree of

MASTER OF SCIENCE IN APPLIED PHYSICS

from the

**NAVAL POSTGRADUATE SCHOOL
December 2005**

Author: Devon Courtney Nugent

Approved by: Richard Christopher Olsen
Thesis Advisor

Gamani Karunasiri
Co-Advisor

James Luscombe
Chairman, Department of Physics

THIS PAGE INTENTIONALLY LEFT BLANK

ABSTRACT

The research described here addresses a technology that may be useful for the defeat of camouflage, concealment, and deception (CC&D). This research aims to study a low cost and highly portable alternative to existing counter CC&D techniques. A commercial off the shelf (COTS) imagery sensor able to distinguish near-infrared (NIR), near-ultraviolet (NUV), and visible wavelengths has been studied. The FOVEON image sensor, a multi-layer focal plane technology, was used in a simple camera implementation to test its viability as a multispectral imager. As expected the sensor functioned as both a visible and NIR detector. Vegetation was easily distinguished based on its NIR reflectance, and man-made materials could be effectively separated from the background

THIS PAGE INTENTIONALLY LEFT BLANK

TABLE OF CONTENTS

I.	INTRODUCTION.....	1
A.	MOTIVATION	1
B.	OBJECTIVE OF RESEARCH.....	2
II.	BACKGROUND	3
A.	OVERVIEW OF CURRENT TECHNOLOGIES BEING USED IN COUNTER-CC&D	3
1.	Foliage-penetrating (FOPEN) Radar	3
2.	Hyperspectral Imagery (HSI)	4
3.	Laser Radar (LADAR)	4
B.	OVERVIEW OF THE FOVEON IMAGE SENOR.....	5
C.	OVERVIEW OF DIGITAL IMAGERY PROCESSING AND ANALYSIS	6
1.	Digital Imagery Analysis Techniques	6
2.	Application of Digital Imagery Analysis Techniques to Counter-CC&D.....	7
III.	CHARACTERIZATION OF THE FOVEON IMAGE SENOR.....	9
A.	PREVIOUS RESULTS.....	9
B.	OVERVIEW OF THE PHOTODETECTOR CHARACTERIZATION SYSTEM.....	10
C.	CHARACTERIZATION RESULTS	11
IV.	HARDWARE	15
A.	THE FOVEON SENSOR TO THE FRAME-GRABBER	15
B.	THE FRAME-GRABBER TO THE IMAGERY ANALYSIS SOFTWARES	16
C.	THE PORTABLE IMAGERY EXPLOITATION SYSTEM.....	17
V.	IMAGERY PROCESSING.....	19
A.	EXTRACTING AND EXPLOITING THE NIR SIGNAL	19
1.	Creation of NIR, NDVI and Probable Non-Vegetation Image Using ENVI.....	20
2.	Creation of NIR, NDVI and Probable Non-Vegetation Image Using IDL.....	22
VI.	EXPLOITING CC&D IMAGERY IN THE FIELD	25
A.	WIDE AREA SCENE WITH HIDDEN OBJECTS IN THE TREE LINE.....	25
B.	A WOODED SCENE WITH CONCEALED ENTRANCE	27
C.	VEHICLES CONCEALED BY TREES AND BUSHES	29
VII.	POTENTIAL APPLICATIONS.....	31
A.	MILITARY APPLICATIONS	31
1.	On the Battlefield	31

2.	Aerial Reconnaissance	32
B.	CIVIL APPLICATIONS.....	32
VIII.	SUMMARY AND RECOMMENDATIONS	33
A.	SUMMARY OF THIS RESEARCH.....	33
B.	RECOMMENDATIONS FOR APPLICATIONS AND FOLLOW-ON STUDIES	33
1.	Upgrade and Use in Training Exercises.....	33
2.	Conduct Further Research to Exploit the NUV Detection Range.....	34
3.	Use of Multiple Spectral Band Pass Filters to Narrow Detection Ranges.....	34
	APPENDIX A - REFERENCE PHOTODIODE RESPONSIVITY VALUES AND CURVE	35
	APPENDIX B - CHARACTERIZATION MEASUREMENTS OF THE REFERENCE PHOTODIODE	37
	APPENDIX C - CHARACTERIZATION MEASUREMENTS OF THE FOVEON IMAGE SENSOR	39
	APPENDIX D - FRAMELINK FRAME-GRABBER FOVEON SPECIFICATION	41
	APPENDIX E - IDL PROGRAM TO DETECT NON-VEGETATION.....	43
	APPENDIX F - FILTER CURVE FOR THE IR TRANSMIT FILTER.....	45
	LIST OF REFERENCES	47
	BIBLIOGRAPHY	49
	INITIAL DISTRIBUTION LIST	51

LIST OF FIGURES

Figure 1.	HVDUO 5M Camera (left). The three p-n junctions in a FOVEON pixel (right) [4].....	5
Figure 2.	Foveon® X3™ Pro 10M CMOS Image Sensor F7X3-A91	10
Figure 3.	Photodetector Characterization System. Taken from reference [8].....	11
Figure 4.	Picture of FOVEON Detector and Reference Photodiode on bench	12
Figure 5.	FOVEON Detectors Responsivity vs. Wavelength	14
Figure 6.	Camera-Link Operation. Taken from Reference [9].....	15
Figure 7.	Frame-Grabber FOVEON Specification.....	16
Figure 8.	The Imagery Exploitation System	17
Figure 9.	FOVEON camera absorption mechanism for various wavelengths [4].....	19
Figure 10.	Pseudo-NIR [left] compare to NIR with filter [right].....	20
Figure 11.	Spectral Reflectance of various material and vegetation versus wavelength from NASA JPL.....	21
Figure 12.	ENVI /IDL function to detect non-vegetation.....	22
Figure 13.	Annotated scene used as input image to IDL Non-Vegetation detection program.....	23
Figure 14.	Above scene with NUV/NIR blocking filter installed.....	23
Figure 15.	Input image [left], IDL created NIR image [right]	24
Figure 16.	IDL created NDVI image [left], IDL created non-vegetation image [right] ...	24
Figure 17.	Wide Area Scene with the NUV/NIR blocking filter in place.....	26
Figure 18.	Wide Area Scene without the NUV/NIR blocking filter	26
Figure 19.	NIR enhance image of Wide Area Scene	27
Figure 20.	Wooded Scene with Concealed Entrance [visible range].....	28
Figure 21.	Wooded Scene with Concealed Entrance with NIR enhanced	28
Figure 22.	Vehicles Concealed by Vegetation [visible range].....	29
Figure 23.	Vehicles Concealed by Vegetation [NIR range].....	30
Figure 24.	Samples of Military portable PCs form the Itronix Military Solutions http://www.itronix.com/industry_solutions/military.asp November 2005	31
Figure 25.	Reference Silicon Photodiode Model UV-035D Calibration Chart	36
Figure 26.	FOVEON Sensor Signals vs. wavelength [above], FOVEON Sensor Responsivity vs. wavelength [below]	40
Figure 27.	R-70 Infrared Transmitting Filter Curve.....	45

THIS PAGE INTENTIONALLY LEFT BLANK

LIST OF TABLES

Table 1.	Reference Silicon Photodiode Model UV-035D Calibration Table	35
Table 2.	Characterization Values for the Reference Photodiode	37
Table 3.	Characterization values for the FOVEON Sensor	39
Table 4.	The Frame-Grabber Specification for the FOVEON Camera	41

THIS PAGE INTENTIONALLY LEFT BLANK

ACKNOWLEDGMENTS

The author would like to extend his appreciation for the support and guidance received during the course of this thesis research work. Firstly, to Professor RC Olsen and Professor Gamani Karunasiri for the generous patience and guidance received throughout this study. The author gained a deeper understanding and appreciation for the rigors that are involved in physics research. Secondly, to Angela Puetz, Research Associate, for the many selfless hours she dedicated to teaching the author the basics of imagery processing and analysis. She made learning the basics of very sophisticated imagery processing applications like ENVI and IDL easy and enjoyable. Thirdly, the author would like to thank Mr. Samuel Barone, the Physics Department's Electronic Technician, for his guidance and assistance in so many areas of this research. His "can-do" attitude and helpful suggested solution to numerous problems that were encountered along the way was greatly appreciated. Lastly, the author like to extend his appreciation to the students and facility of the Physics Department in the Naval Postgraduate School for their generous help and support which has made this experience a worthwhile and enriching one.

THIS PAGE INTENTIONALLY LEFT BLANK

I. INTRODUCTION

A. MOTIVATION

The world of digital imagery has seen significant growth in recent years, both in the technology of imagery acquisition and in the technology and the techniques of imagery progressing and analysis. During this time the face of the military battlefield has also seen significant changes. The modern enemy is no longer predictable both in his identity or his methods. The enemies the military face today do not advertise their presence nor do they conduct overt attacks. Their greatest weapon is their expert use of the murky shadows from which they strike. Concealment and deception is their primary means of warfare. In response to this modern threat the military has been aggressively pursuing various methods to deprive the enemy of his camouflage, concealment and deception. The mission area of Counter-Camouflage, Concealment and Deception (Counter-CC&D) is currently receiving considerable attention by the military and the intelligence community as they struggle to use modern technology to counter the oldest tricks in the book of warfare. Unfortunately, many of the technologies that are being pursued are too bulky, too costly or plagued with low detection rates and high false-alarms. Some are based on immature technology making them unlikely to produce a useful product to meet the warfighter needs in the immediate future.

A low cost commercially available camera may assist the warfighter in this counter-CC&D role. This camera utilizes the unique triple-well FOVEON focal plane. The FOVEON design is a multi-layer Complementary Metal Oxide Semiconductor (CMOS) focal plane that allows the acquisition of spectral imagery in the near ultra-violet (NUV), visible and the near infrared (NIR). The exploitation of these images with commercially available imagery analysis software holds the potential to detect man-made objects hiding in natural surroundings by analyzing the reflectance and absorption characteristics of the objects in the digital scene.

B. OBJECTIVE OF RESEARCH

The objective of the research is to explore commercially available, low cost and highly portable imagery exploitation systems to be utilized in the Counter-CC&D military mission area. The research focuses on the unique multispectral detecting capability of the FOVEON image sensor. The FOVEON sensor is exploited to create a low cost, lightweight Counter-CC&D tool that can be used by the military in the field. The study continues the work began in the December, 2004 Naval Postgraduate School thesis by Major Cheak, entitled Detecting Near-UV and Near-IR Wavelengths with the FOVEON Image Sensor.

In the work that follows, the FOVEON image sensor was characterized in the laboratory then the imagery system was assembled. The system consisted of the image sensor, a portable laptop computer, a frame-grabber, and a digital imagery progressing and analysis software tool. The imagery analysis platform is then used to acquire and study imagery of a Counter-CC&D nature with the goal of creating a database of imagery processing techniques to be utilized by the military in the field.

II. BACKGROUND

A. OVERVIEW OF CURRENT TECHNOLOGIES BEING USED IN COUNTER-CC&D

Counter-CC&D is the ability to detect obscured targets in foliage, under camouflage, in shallow hides, or those utilizing deception techniques. In this military mission area the current standard techniques in use is long wavelength synthetic aperture radar (SAR) to penetrate foliage and other materials. Foliage and most covering materials are transparent to long electromagnetic wavelengths. Research and technical demonstrations are also being conducted to demonstrate the utility of hyperspectral imagery in a Counter-CC&D role. The use of Laser Radar (LADAR) is also being studied as a means of countering CC&D. A brief overview of these areas is presented below.

1. Foliage-penetrating (FOPEN) Radar

Foliage-penetrating (FOPEN) radar operating in the VHF or UHF frequency ranges are being utilize on UAVs such as Global Hawk and on manned surveillance aircraft like the Army RC-12. Long wavelength electro-magnetic energy penetrates vegetation and lightweight covering with little attenuation. FOPEN SAR has been in use by the military for several years and it is a proven technology for detecting targets at long range in all weather and lighting condition.

Moyer [1] noted that the same physical mechanism that gives FOPEN SAR its penetrating power is also the reason for its limitations, its use of long wavelength energy.¹ The resolution of FOPEN SAR imagery is poor due to the inverse relationship between resolution and wavelength. Poor resolution and the large amounts of surface clutter reflection leads to missed targets and a very high false-alarm rate. Also, it is not readily portable due to the bulky radar support gear that is required. FOPEN SAR is further challenged by the crowded VHF and UHF spectrum in which it operates. FOPEN SAR suffers from radio frequency interference from radio stations, TV stations, commercial and military communications.

¹ Lee Moyer, Defense Advanced Research Projects Agency (DARPA) Special Project Office CC&D Program Manager's speech

2. Hyperspectral Imagery (HSI)

As outlined in Pabich [2], hyperspectral imagery (HSI) holds potential for military application in the area of Counter-CC&D. By analyzing the multiple spectrum bands of HSI it is possible to detect concealed targets by keying on their reflectance differences at non-visual wavelengths. This property gives HSI the ability to distinguish real targets from decoy thereby preventing the waste of expensive precision munitions on decoys. It can also detect targets hiding in backgrounds and/or under camouflage.

DARPA, the Army, the Navy, and the Air Force all have ongoing HSI research projects utilizing both airborne and space based systems. HSI appears to offer excellent future potential for the military, but as was pointed out in Pabich [2] given the newness of this technology it will take some time before the Department of Defense (DoD) works through the numerous administrative and logistics hurdles in the way of putting usable HSI technology in the hands of the warfighter.

3. Laser Radar (LADAR)

DARPA has been conducting research into the use of LADAR to detect concealed targets in foliage or under camouflage as discussed in Hauge [3]. Using short pulse (2 nanosecond) LADAR, the capability of identifying tanks under a forest canopy has been demonstrated. The forest canopy reflects most of the transmitted LADAR energy except that portion which passes through the gaps and is reflected by the target. The LADAR returns are in the form of range to the target, which lends itself to the creation of 3-D images, which aids in the target recognition process.

To make LADAR a useful Counter-CC&D technology for the warfighter in the field the size and power requirements of the laser must be decreased. Also due to high atmospheric attenuation that occurs in the LADAR operating frequency band the operational range of the system is currently limited. DARPA is working on these and others limitations in an attempt to make LADAR a useful military counter-CC&D tool in the near future.

B. OVERVIEW OF THE FOVEON IMAGE SENSOR

The operation and characteristics of the FOVEON image sensor has been covered thoroughly in Cheak [4]; a brief overview is presented here. The FOVEON image sensor differs from traditional photodetector in its construction and that physical difference is the source of its unique spectrum properties. Unlike traditional semiconductor photodetectors that only detect one primary color per detector and then simulate the other two primary colors by means of interpolation and integration, the FOVEON sensor detects all three primary colors in each detector by exploiting the variation of the radiation absorption coefficient of silicon with wavelength and depth. This capability of detecting the three primary colors in each detector and therefore in each pixel gives the FOVEON sensor three times the resolution of a traditional focal plane with the same number of detectors.

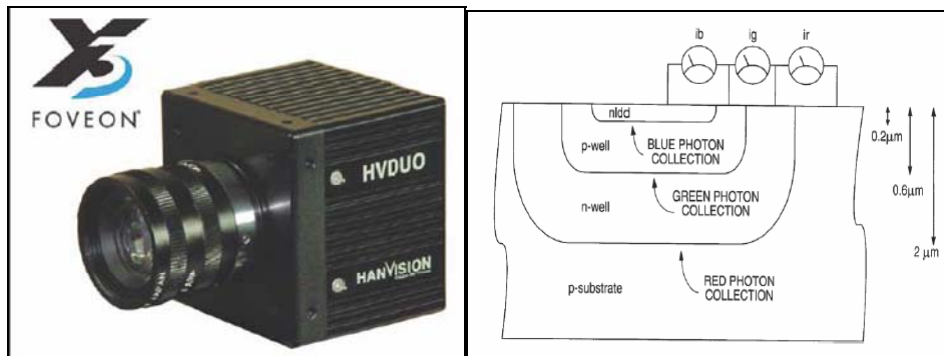

Figure 1. HVDUO 5M Camera (left). The three p-n junctions in a FOVEON pixel (right) [4]

The marketed purpose of the FOVEON detector is for utilization in the visible spectrum range, but its unique triple well construction also gives it the added ability to detect NUV in the shallowest well and NIR in the deepest well. This essentially makes the FOVEON sensor a multispectral detector. It was shown by Cheak [4] that the FOVEON detection capability coupled with selected spectral filters could produce images in the NUV, visible, NIR and in combinations of all three spectral bands. It is this ability of the FOVEON sensor to detect non-visible electromagnetic radiation especially

in the NIR that makes it a potential Counter-CC&D tool. Analysis of the NIR reflectance from objects in the scene can aid in distinguishing natural from man-made objects.

C. OVERVIEW OF DIGITAL IMAGERY PROCESSING AND ANALYSIS

Due to increased processing power, memory capacity, and speed of modern computers, digital imagery processing and analysis is now a viable tool for all levels of technical investigations. As Jahne [5], notes gone are the days when imagery processing required large mainframe computers and large memory storage devices. Today most imagery processing can be done on standard personal computers. The wide availability, low cost, and ever-decreasing size of computers have made them an appropriate tool for the warfighter in the field. Also powerful imagery software tools are now available from numerous manufacturers that can easily do the kind of processing and analysis that is required for deriving useful information from raw imagery acquired in the field.

Digital imagery processing, as described in Russ [6], is the use of a digital computer to (1) improve the visual appearance of an image or (2) to prepare the image for measurement of features and structures that are present. Digital imagery analysis is the use of mathematical algorithms to transform the raw image in some preferential way to allow the extraction of arbitrary information, such as classification, pattern recognition and edge detection.

1. Digital Imagery Analysis Techniques

Digital imagery analysis is currently being utilized in countless fields from manufacturing of paints to the study of the universe. As illustrated in Environment for Visualizing Images (ENVI) User's Guide [7], current digital imagery analysis techniques can be generally grouped into four board areas: Classification, Transformations, Filters and Analyzing Tools.

Imagery classification is the process of categorizing each pixel in the digital scene by type and features. Some common methods of classifying a digital scene are Parallelepiped, Minimum Distance, Mahalanobis Distance, Maximum Likelihood and Spectral Angle Mapper.

The goal of imagery transformation is to improve the interpretation of the image by transforming it into another data space where the features in question can be more clearly seen. Transformations are usually performed by applying a linear function thereby preserving the integrity of the image. Some common transformation methods are, Image Sharpening, Spectral Sharpening, Principal Component Analysis, Color Transformations, and Vegetation Indices Transforms such as Normalized Difference Vegetation Index (NDVI) and Tassled Cap.

Filters are used on images to remove certain spatial frequencies. Some common filters used in imagery processing are Convolution, Morphological, Texture, Adaptive and Fourier Filtering.

Many analyzing tools are available in most digital imagery analysis software packages. There are spectral tools for analyzing the spectral data in multispectral and hyperspectral images. There are map tools for image registration, orthorectification, geometric correction, and mosaicking. Some analysis software also includes specialized tools to work with radar imagery and topographical tools for working with digital elevation data.

2. Application of Digital Imagery Analysis Techniques to Counter-CC&D

For the purpose of analyzing Counter-CC&D images the use of selected methods and tools from all of the above areas may be necessary. Due to the need to distinguish man-made object from natural objects the transformation techniques of NDVI will be the most useful. Also the ability to conduct mathematics of spectral bands in a digital image will be relied upon heavily.

THIS PAGE INTENTIONALLY LEFT BLANK

III. CHARACTERIZATION OF THE FOVEON IMAGE SENOR

A. PREVIOUS RESULTS

The FOVEON image sensor was characterized in Cheak [4], but due to low sensor response at some wavelengths the camera's built in processor had to be used to compensate the output in order to obtain adequate measurements. The built in processor is controlled by the software that was shipped with the camera and would not be used for this work due to its lack of portability. It was therefore necessary to re-characterized the sensor before proceeding with this work. Also, the present work is focus in the NIR range of the sensor. Therefore a more detailed characterization in that wavelength range was needed.

The goal of characterizing any image sensor is to obtain a plot of the sensor's electrical response to the presence of light of a given intensity at varying wavelengths. To obtain this plot it was necessary to subject the sensor to monochromatic light of known intensity and measure its response at each wavelength of interest. The sensor's response is termed the "Responsivity" of the detector. Once the characteristic responsivity of a detector is known the output signal of that detector can then be determined from the intensity and wavelength of future observations with the detector.

The work by Major Cheak confirmed that the responsivity of the FOVEON image sensor measured in the laboratory was similar to that which was provided by the manufacturer in the intended operational range of 450 to 700 nanometers (nm), the visible range, as shown in Figure 1 below. In an attempt to fully characterize the FOVEON sensor Major Cheak submitted the detector to light ranging from 200 nm (NUV) to 1100 nm (NIR). There were numerous difficulties in obtaining measurable signals in the range below 400 nm. These difficulties were again seen in the present work at lower than 400 nm. This low responsivity is believed to be the combined effects of the design bias of the monochromator diffraction grating and the reflectivity of the mirrors used in the Photodetector Characterization System. More work is needed to understand and overcome these difficulties before this range of the FOVEON sensor can be exploited

for potential military application. Since, the primary focus of this work was in the visible and NIR ranges the NUV measurements are not included in this discussion.

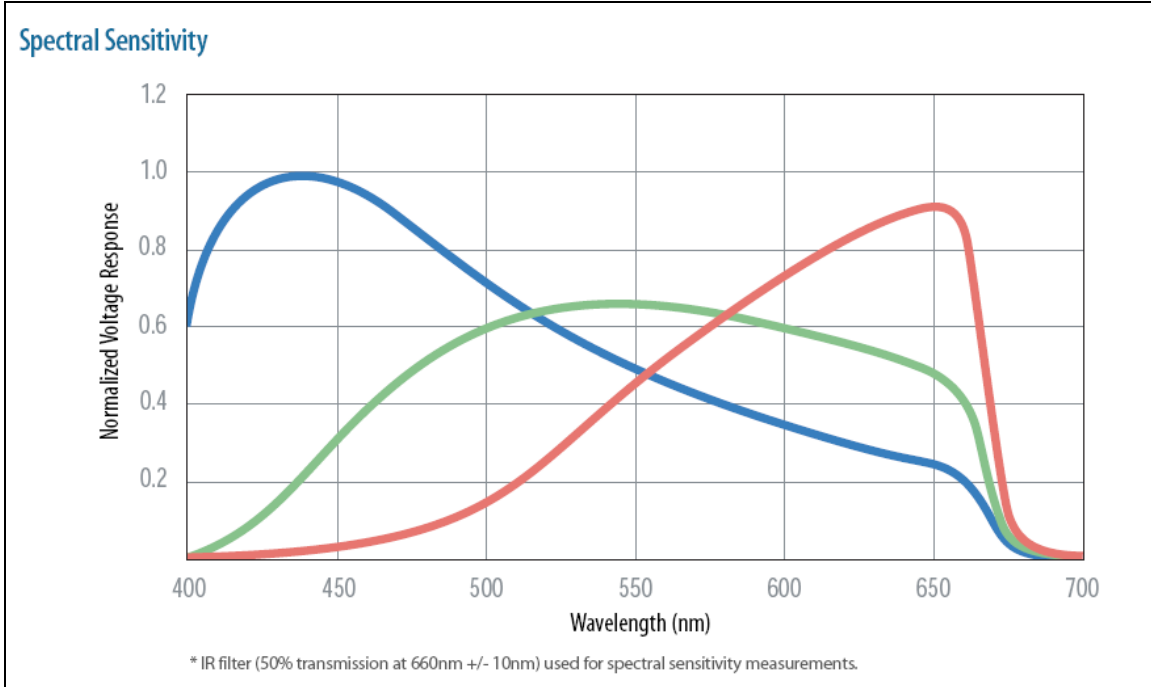

Figure 2. Foveon® X3™ Pro 10M CMOS Image Sensor F7X3-A91

In order to exploit the NIR range of the FOVEON sensor for Counter-CC&D purposes it was therefore necessary to generate responsivity curves for the FOVEON sensor that extended into the NIR range (700 – 1100 nm).

B. OVERVIEW OF THE PHOTODETECTOR CHARACTERIZATION SYSTEM

The Computer-Controlled Photodetector Characterization System was created by LCDR Herdlick as his Naval Postgraduate School Thesis work. Herdlick [8] was used to operate the characterization system for studying the FOVEON sensor both in this work and Cheak [4]. The system is depicted below in Figure 3. The system consisted of an analysis computer, a light source, a monochromator, two lock-in amplifiers and an assortment of mirrors and detector connection points assembled on a light bench. There is

also a thermally controlled sensor housing to be used with cooled IR sensors. This portion of the system was not used for this work.

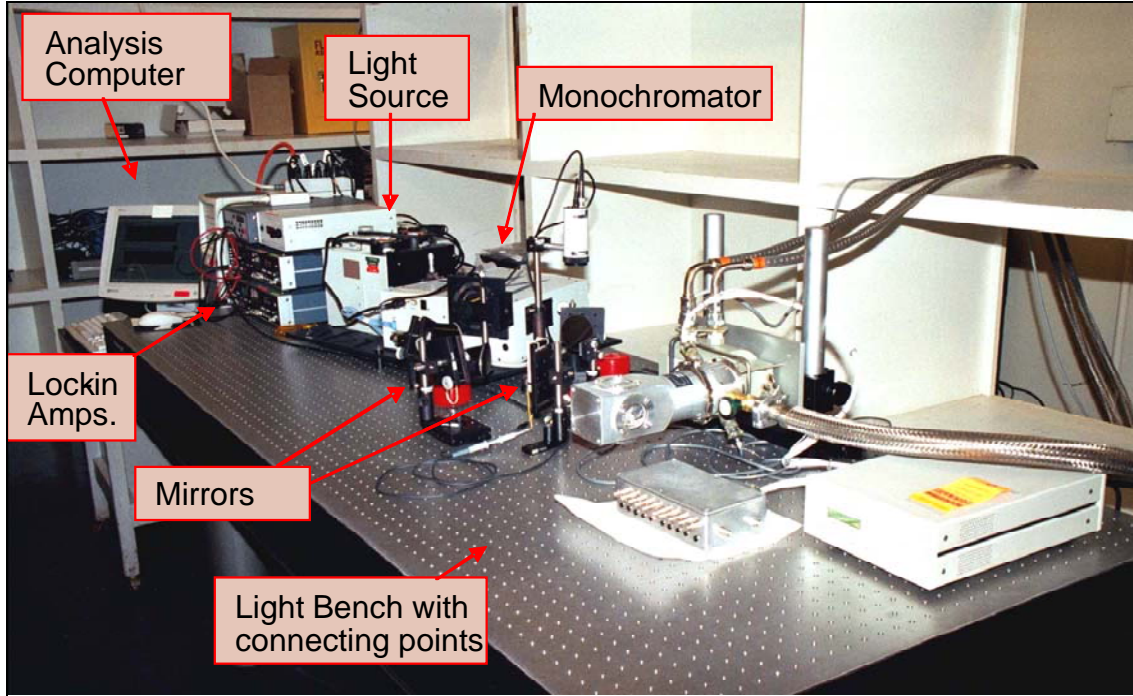

Figure 3. Photodetector Characterization System. Taken from reference [8]

In addition to the existing characterization system the reference silicon photodiode, model PIN UV-035D, serial number 7309 used in Cheak [4] was again used. Calibration details for the reference silicon photodiode can be found in Appendix A. An aluminum coated splitting mirror was added to divide the light from the monochromator evenly between the FOVEON sensor and the reference photodiode.

C. CHARACTERIZATION RESULTS

Additional details of the FOVEON image sensor characterization including spreadsheets and additional graphs can be found in Appendix B. The basic approach and the results are summarized here. The FOVEON sensor and the reference photodiode were arranged to receive equal portions of the light emitted from the monochromator, as shown in Figure 4. The Photodetector Characterization System was controlled by the LABVIEW controlled program written in Herdlick [8]. The LABVIEW program also adjusted the

wavelength of the light coming from the monochromator and collected the readings from the reference photodiode. As in Cheak [4] the readings from the FOVEON sensor was obtained by taking picture at each wavelength by utilizing the control and imagery progressing software that came with the camera. The collected data was then exported into a spreadsheet and the graphs were created based on the collected data.

Using the detector area of the reference photodiode and the FOVEON sensor provided by the manufacturers and the size of the incident light beam an effective area for each detector was calculated for use in the responsivity calculating spreadsheet. The width of the incident light beam was estimated to be the width of the monochromator output slit assuming negligible spreading of the beam over the focal length of the mirrors which was 4.7 inches.

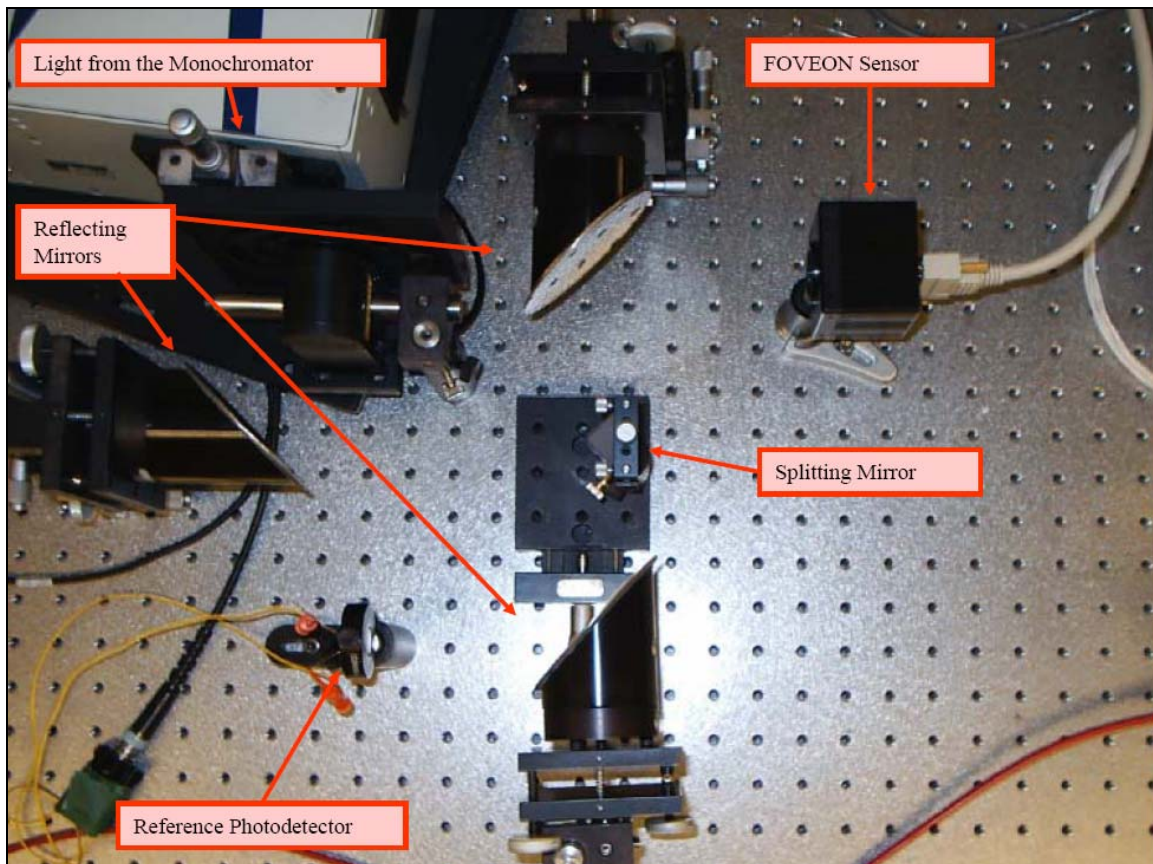

Figure 4. Picture of FOVEON Detector and Reference Photodiode on bench

Some mathematical manipulations of the data were required to arrive at the responsivity of each of the three photodetectors that makes up each of the FOVEON sensor pixel. The calculations used are as follows:

Using the known responsivity of the reference photodiode as a function of wavelength, $R_{\text{ref}}(\lambda)$ listed in Appendix A and the measured signal of the reference photodiode, $S_{\text{ref}}(\lambda)$ the power incident on the reference photodiode can be calculated as:

$$P_{\text{ref}}(\lambda) = S_{\text{ref}}(\lambda) / R_{\text{ref}}(\lambda) \quad (1)$$

By dividing the power incident on the reference photodiode by the area of the reference photodiode the intensity of the light that is incident on both the reference photodiode and the FOVEON sensor can be found as:

$$I_{\text{ref}}(\lambda) = I_{\text{FOV}}(\lambda) = P_{\text{ref}}(\lambda) / A_{\text{ref}} \quad (2)$$

By multiplying the light intensity by the area of the FOVEON sensor the power incident on the FOVEON detector can be found as:

$$P_{\text{FOV}}(\lambda) = I_{\text{FOV}}(\lambda) \times A_{\text{FOV}} \quad (3)$$

With the incident power on the FOVEON sensor and the measured signal from the FOVEON sensor the responsivity of each of the three FOVEON photodetectors can be determined as:

$$R_{\text{FOV}}(\lambda) = S_{\text{FOV}}(\lambda) / P_{\text{FOV}}(\lambda) \quad (4)$$

The resulting graphs of the measured FOVEON responsivity in the NIR range (700 – 1100 nm) are shown in Figure 4 below. A pseudo-NIR responsivity curve was also generated by subtracting the green code band from the red color band. This was done based on the fact that the long wavelengths in the NIR range pass through both the blue and the green photodetector before being recorded in the red photodetector. The derivation of this pseudo-NIR will be more fully addressed later in chapter five.

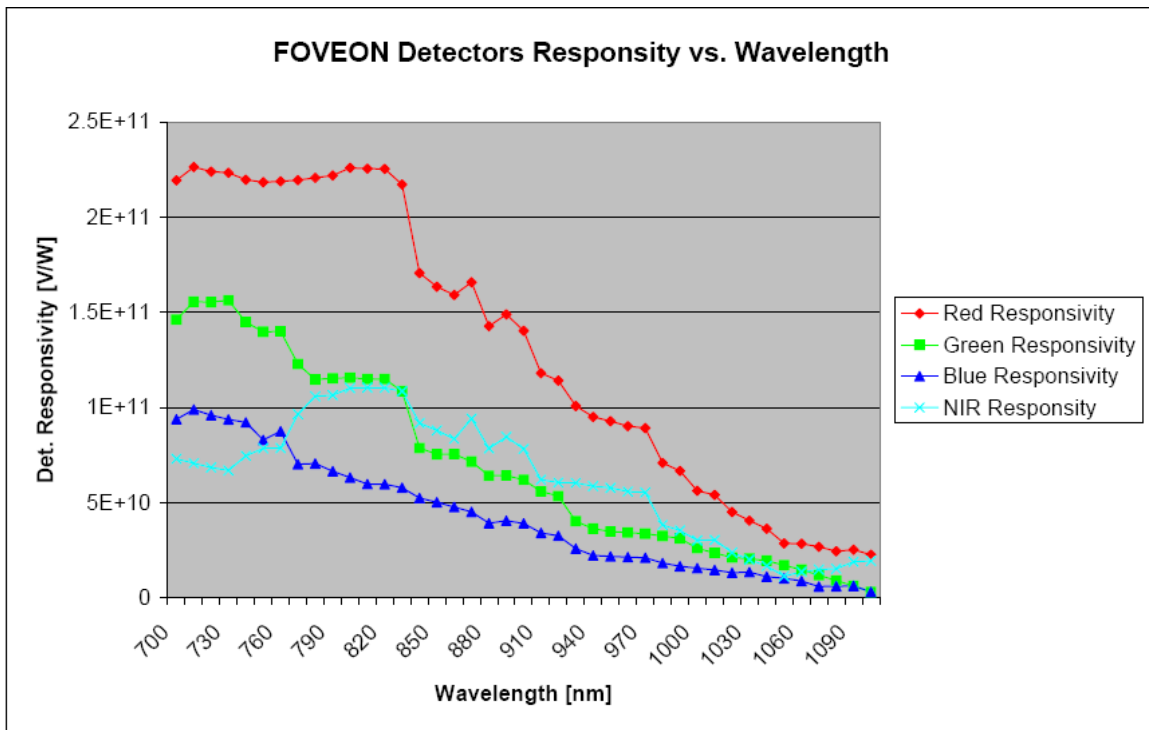

Figure 5. FOVEON Detectors Responsivity vs. Wavelength

IV. HARDWARE

A. THE FOVEON SENSOR TO THE FRAME-GRABBER

The goal of this work was to create a portable imagery system that can be used in the field to counter camouflage and deception to achieve this end it was necessary for the FOVEON camera be mated to a portable computer. The frame-grabber and analysis software used in Cheak [4] were not available in portable versions therefore a new frame-grabber was needed that would work with the FOVEON camera and a standard laptop computer. The signal output of the FOVEON camera supported the Camera-Link™ specifications, which is an interface standard for digital cameras and frame-grabbers.

The job of a frame-grabber is to capture digital video data from a camera and transfer it into the memory of a host computer. A FRAMELINK™ frame-grabber made by Imperx Incorporated was chosen based on its support for Camera-Link™ and its rugged design. Camera-Link™ is a registered trade mark of the National Semiconductor Corporation which created it based on ANSI/TIA/EIA-644 general purpose interface standard. Camera-Link™ uses Low Voltage Differential Signaling (LVDS), which is a high-speed, low-power signal protocol that is capable of data transfer speeds up to 1.9 Gbps, as noted in the specifications of the Camera Link Interface Standard for Digital Cameras and Frame Grabbers [9]. Camera-Link™ transfer data over a connecting cable as shown in Figure 5.

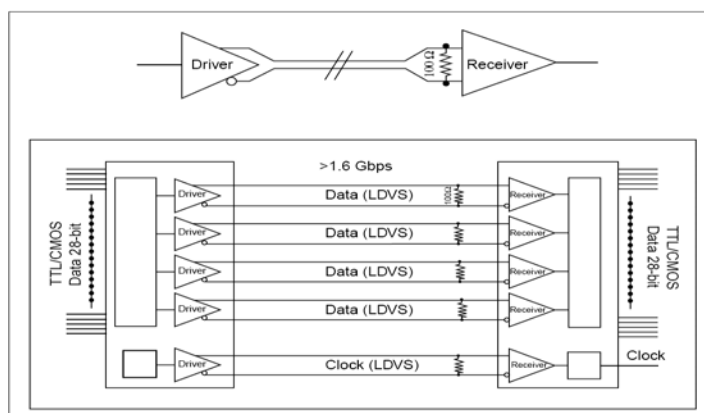

Figure 6. Camera-Link Operation. Taken from Reference [9]

The FRAMELINK™ frame-grabber came with an application that configures the frame-grabber to the specifications of each camera, thereby allowing the capture of images from that camera. The required specification for the FOVEON camera was arrived at by a combination of communications with the manufacturers of the frame-grabber and the camera and trial and error. The specification that resulted in successful operation was saved in a configuration file (.cam) in Appendix D and below in Figure 6.

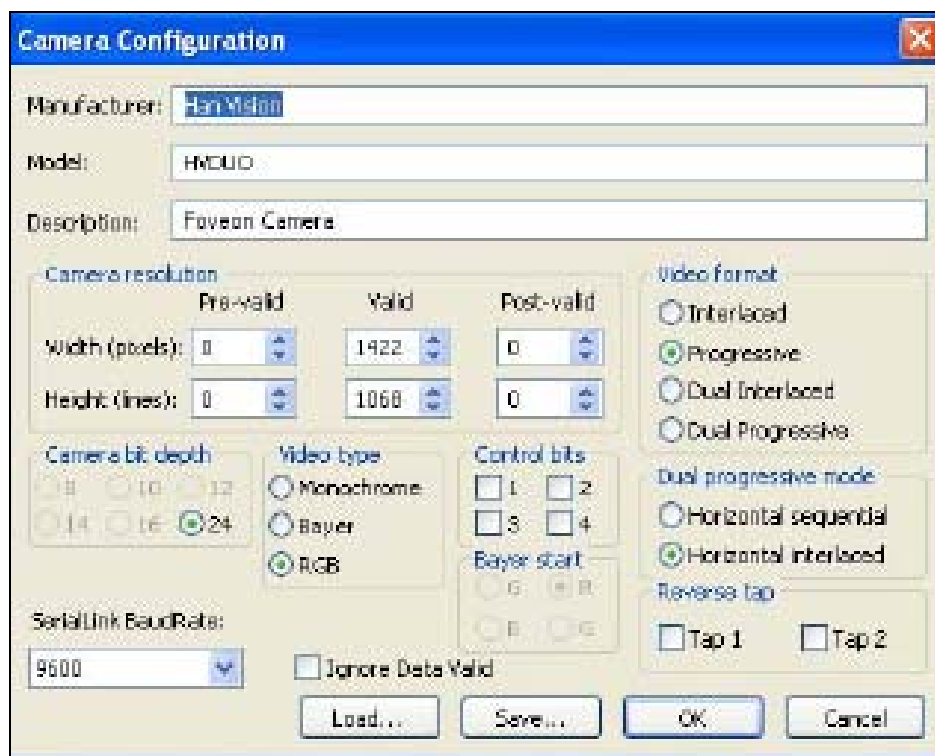

Figure 7. Frame-Grabber FOVEON Specification

B. THE FRAME-GRABBER TO THE IMAGERY ANALYSIS SOFTWARES

The frame-grabber application software facilitated the capture of images from the camera and gave the option of saving the images in one of three image format, (Bitmap, JPEG, or TIFF). TIFF was found to be the best format for the import of imagery into the analysis software. The chosen imagery analysis software for this work was ENVI® (Environment for Visual Images). ENVI®, (here after referred to as ENVI) is an

innovative, user-friendly environment written in Interactive Data Language (IDL®), (here after referred to as IDL). ENVI and IDL are registered trademarks of Research System Incorporated (RSI). The images were also manipulated in IDL as a faster but more code intensive means for deriving the intelligence value. Operation guidance for ENVI was found in ENVI [7], and for IDL in the IDL Users Manual [10].

The saved imagery from the camera was imported into ENVI and IDL as three color band RGB images. This allowed each of the three color bands to be manipulated separately. With the imagery analysis tools in ENVI and the programming power of IDL it is then possible to perform mathematical operations on the color bands to extract the NIR data and use it to determine the vegetation index of a digital image scene. A vegetation index enhanced image would facilitate the identification of non-vegetation type objects in a vegetation intense environment.

C. THE PORTABLE IMAGERY EXPLOITATION SYSTEM

The portable imagery exploitation system as shown in Figure 8, is comprised of the FOVEON camera, a custom filter holder, the frame-grabber with connecting cable and the laptop computer running ENVI and/or IDL as a imagery exploitation tool. The goal of this work is to create an easy to use system with few attachments.



Figure 8. The Imagery Exploitation System

THIS PAGE INTENTIONALLY LEFT BLANK

V. IMAGERY PROCESSING

A. EXTRACTING AND EXPLOITING THE NIR SIGNAL

To utilize the Normalized Difference Vegetation Index (NDVI) as a means of detecting vegetation in a scene the presence of a separate NIR band is needed, since NDVI is a function of the difference between the reflectance in the NIR band and the red band as seen in equation (5) below. The imported FOVEON images only consisted of three color bands; red, green and blue (RGB). The generation of a separate NIR band from the FOVEON image is needed. The physical design of the FOVEON sensor results in the NIR signal being primarily detected in the deep photodetector. As was discussed in Cheak [4], long wavelength radiation passes through and interacts with all three photodetectors in FOVEON sensor, but due to the relatively thin absorption region in the upper photodetectors the response is minimal. The main interaction of the red and NIR radiation is the green and red photodetectors. It was therefore theorized that the subtraction of the green photodetector response from the red photodetector response would result in an approximate representation of the NIR signal.

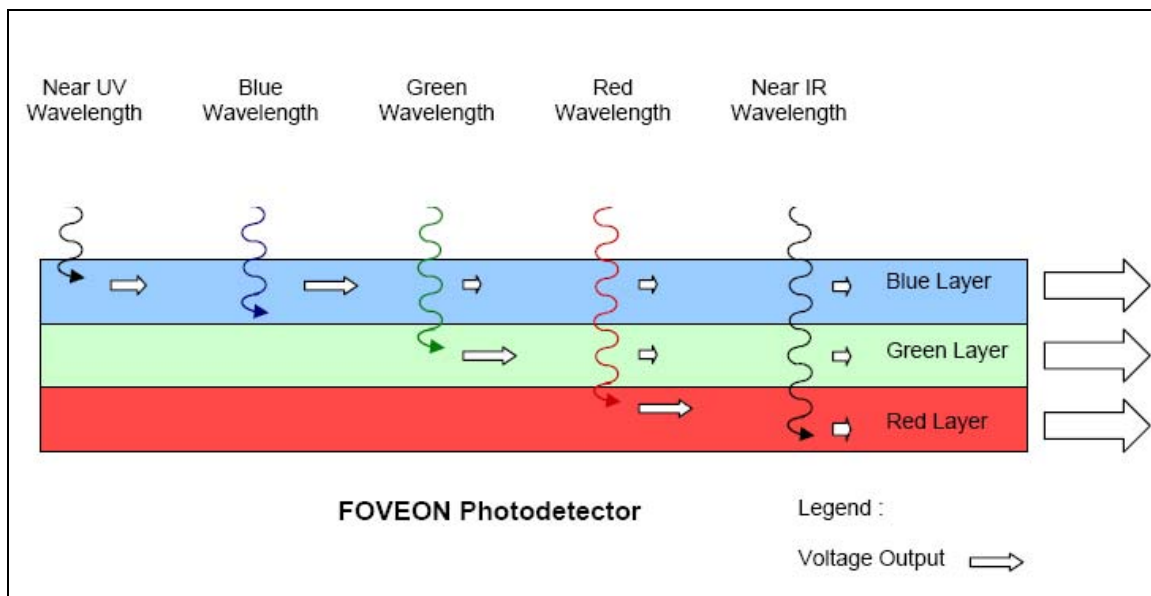

Figure 9. FOVEON camera absorption mechanism for various wavelengths [4].

To test the above theory a pseudo-NIR image was created using the above theory then compared against an image taken with a NIR filter installed to block all light below the NIR band. The two images are compared below in Figure 10. The scene is of a potted plant with bushes to the left and two concrete pillars and more bushes in the background. Vegetation in the scene is more reflective in the NIR band than non-vegetation therefore the vegetation appear brighter.



Figure 10. Pseudo-NIR [left] compare to NIR with filter [right]

The above demonstrates that the extraction of the NIR information from the red and green color bands by mathematical manipulation provides a reasonable approximation of the true NIR reflectance. This will be used in the imagery progressing that follows.

1. Creation of NIR, NDVI and Probable Non-Vegetation Image Using ENVI

NDVI is able to indicate vegetation due to the differential reflectance of vegetation in red band (580 – 680 nm) and the NIR band (750 – 1100 nm). As can be seen in Figure 11 below vegetation exhibits a sharp rise spectral reflectance around 700 nm. This sharp rise in reflectance is often referred to as the vegetation IR ledge. The NDVI calculation exploits the IR ledge to detect the presence of vegetation in the image scene.

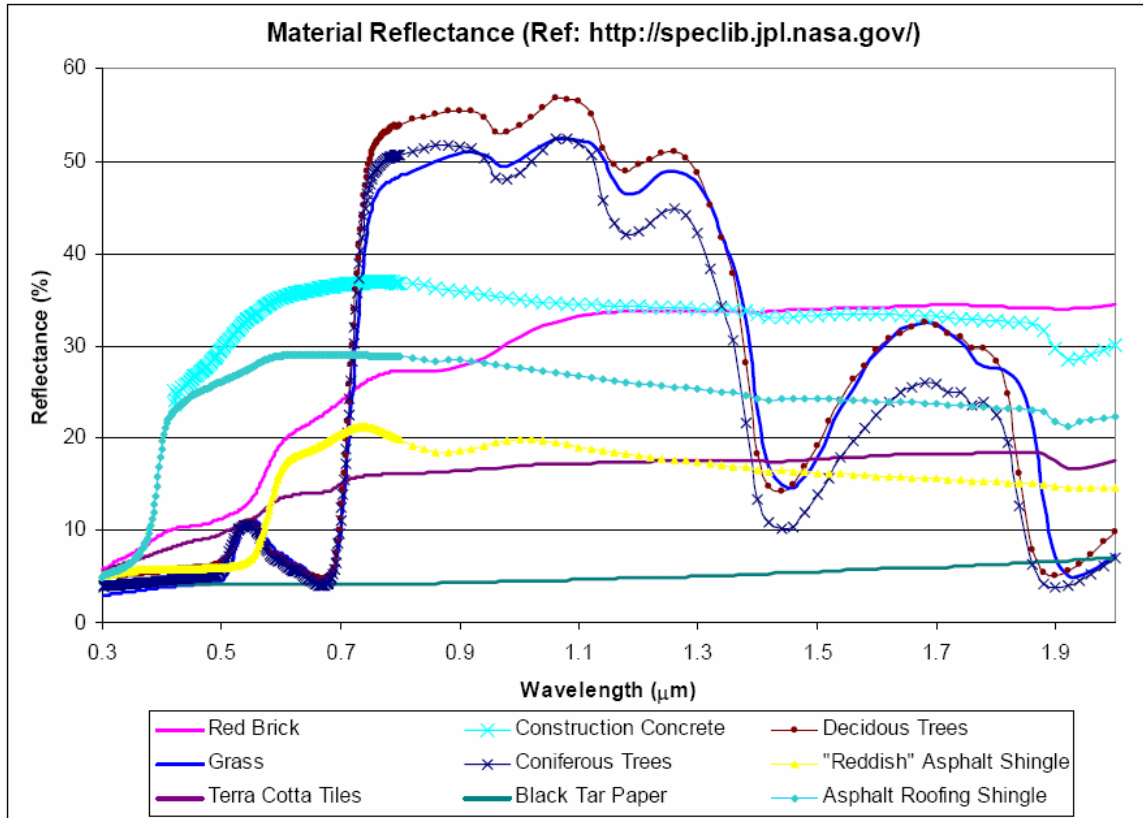

Figure 11. Spectral Reflectance of various material and vegetation versus wavelength from NASA JPL

Images from the FOVEON camera saved in Tagged Image File format (TIFF) are loaded directly into ENVI. In addition to displaying the image as a RGB color image, ENVI can also display each color band separately. This allows mathematical operations on each band. The pseudo-NIR band was created in ENVI by using one of the built-in basic tools called “Band Math”. ENVI gave the option of conducting a mathematical operation to subtract the green color band from the red color band to create the NIR band and then to conduct another operation to create an NDVI grayscale image as follows:

$$NDVI = (NIR - Red) / (NIR + Red) \quad (5)$$

There is also the option of creating a user defined “FUNCTION” written in IDL to execute both operations plus more. The below sample “FUNCTION” called “detect

non-veg” was used to calculate the NIR band, then used the NIR band to calculate NDVI and then created an image showing the probable locations in the scene where non-vegetation exists.

```
{An user define Band Math function for uses in ENVI to calculate NIR,  
NDVI and probable non-vegetation written in IDL}  
  
FUNCTION detect_non_veg, b1, b2  
NIR = float(b1)-float(b2)  
NDVI_float = (NIR - b1) / (NIR + b1)  
NDVI = BYTSCL(NDVI_float, min=-3, max=5)  
NON_VEG = NDVI LT MEAN(NDVI)  
RETURN, NON_VEG  
END
```

Figure 12. ENVI /IDL function to detect non-vegetation

The advantage of using a full imagery processing software application like ENVI is the availability of numerous powerful imagery manipulation tools that can be used to enhance the displayed image to aid in target detection. The disadvantage is the time required to accomplish the progressing due to the numerous menus that have to be navigated. A full and flexible imagery processing application like ENVI is more appropriate in post-processing applications vice the near-real time processing that is required for operations in the field.

2. Creation of NIR, NDVI and Probable Non-Vegetation Image Using IDL

Using the Interactive Data Language (IDL), the language that ENVI was written in, it is possible to conduct the required imagery processing in near-real time. This required creating and compiling a program written in IDL to load the input image, conduct the band mathematics to create the NIR band, and then calculates the NDVI to detect the probable locations of non-vegetation items in the scene. A sample program that achieves this is listed in Appendix E. The image depicted below in Figure 13 was used as the input image for the program. Note that with the manufacturer’s NUV/NIR blocking filter removed the colors in the image scene are skewed due to the NIR radiation reflecting off the green vegetation and being detected in red color bands. When the

blocking filter is re-installed the scene appears normal in color as seen in Figure 14. Also note how much brighter the image that includes the NIR reflectance is compare to the same scene without the NIR.



Figure 13. Annotated scene used as input image to IDL Non-Vegetation detection program



Figure 14. Above scene with NUV/NIR blocking filter installed

With Figure 13 as the input file to the IDL program the below output images files were created and displayed.



Figure 15. Input image [left], IDL created NIR image [right]

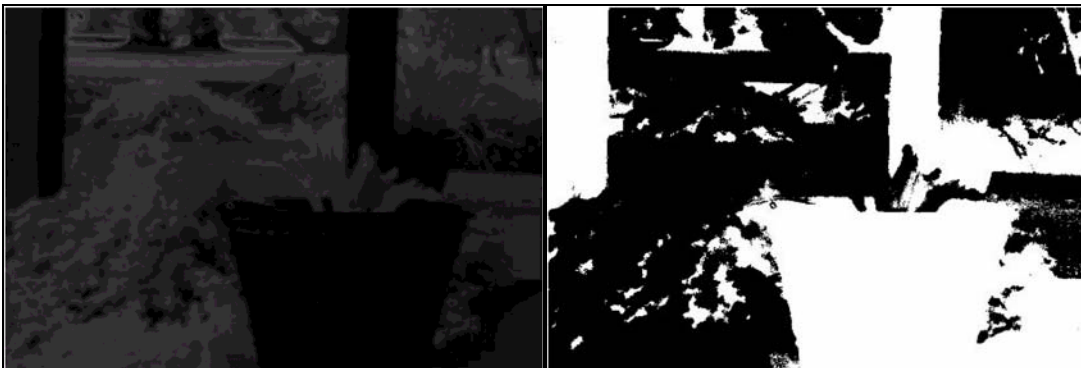

Figure 16. IDL created NDVI image [left], IDL created non-vegetation image [right]

As can be seen in the above images exploiting the NIR reflectance of vegetation can be used to enhance the appearance of non vegetation in a scene even in a low light condition.

VI. EXPLOITING CC&D IMAGERY IN THE FIELD

After the development of the imagery exploitation hardware and the creation and testing of the software under laboratory conditions the next step was to take the system into the field and test it against pseudo camouflage and deception targets. Due to the lack of accessibility to real camouflage and deception targets in the immediate area, accessible scene in the local area were used to test the capability of the imagery system. One problem that was encountered when the system was exposed to full sunlight was the issue of over-exposure. As was seen above adding in the NIR reflectance greatly increases the brightness of the scene. When this was done in full sunlight the images were over-saturated. This required carefully reducing the shutter opening to limit the exposure. Once the over-exposure problem was adjusted for the three scenes below were imaged in an attempt to re-create typical counter-CC&D scenes that may be encountered on the battlefield.

A. WIDE AREA SCENE WITH HIDDEN OBJECTS IN THE TREE LINE

The first scene is of a dense tree lined area with numerous man made objects hidden amongst the trees. The first image below, Figure 17, was taken with the manufacture's NUV/NIR blocking filter installed therefore it only shows the information available in the visible range. One items of note in this scene is the faint power lines running horizontally across the image. These could present an aircraft navigation hazard in an unknown area. Notice how the power lines are more visible when the NIR reflection of the trees is enhanced in Figure 19.



Figure 17. Wide Area Scene with the NUV/NIR blocking filter in place

There is also a building in the background with two cars parked in front. The building is almost invisible in the Figure 17 above because it is grey-brown in color thereby blends well into the natural background. The two cars in front of the building are partially visible due to the sun reflecting off their silver colored reflecting surface. This would not be the case if they were painted a flat camouflage color.



Figure 18. Wide Area Scene without the NUV/NIR blocking filter

In Figure 19 the two parked cars shows up as notable dark spots against the NIR enhanced background indicating that they are clearly non-vegetation.

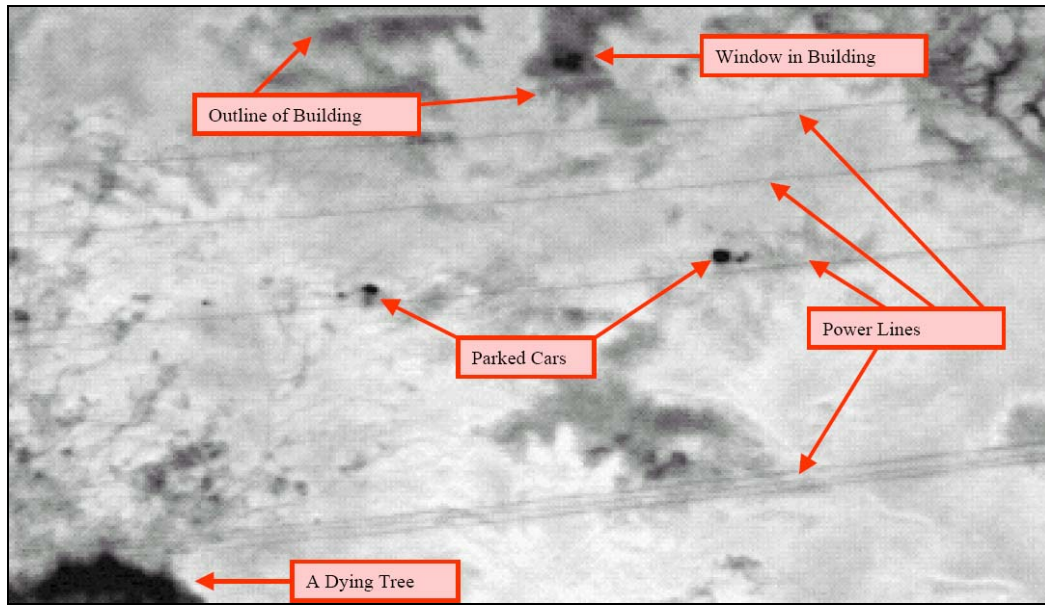

Figure 19. NIR enhance image of Wide Area Scene

Also from the stand point of monitoring vegetation health, the tree in the lower left hand corner of Figure 19 is reflecting almost no NIR indicating possible poor health.

B. A WOODED SCENE WITH CONCEALED ENTRANCE

The second scene is of a wooded area with a partially concealed underground entrance way to an adjacent building, Figure 20. This type of concealment is a common method of hiding the entrance to underground bunkers. This image was taken from the roof of a nearby six floor building. It is somewhat representative of a low flying airborne photograph. In the visible range the entrance is partially blocked by the trees and brushes and not very visible to the observer. If it was painted to blend in with the natural surroundings this entrance would be easily missed by an airborne reconnaissance platform.



Figure 20. Wooded Scene with Concealed Entrance [visible range]

When the NIR reflected by the vegetation is used to enhance the scene, Figure 21, the entrance stands out as dark spot in a mostly light background. This contrast should be enough to alert an operator to investigate this area more.

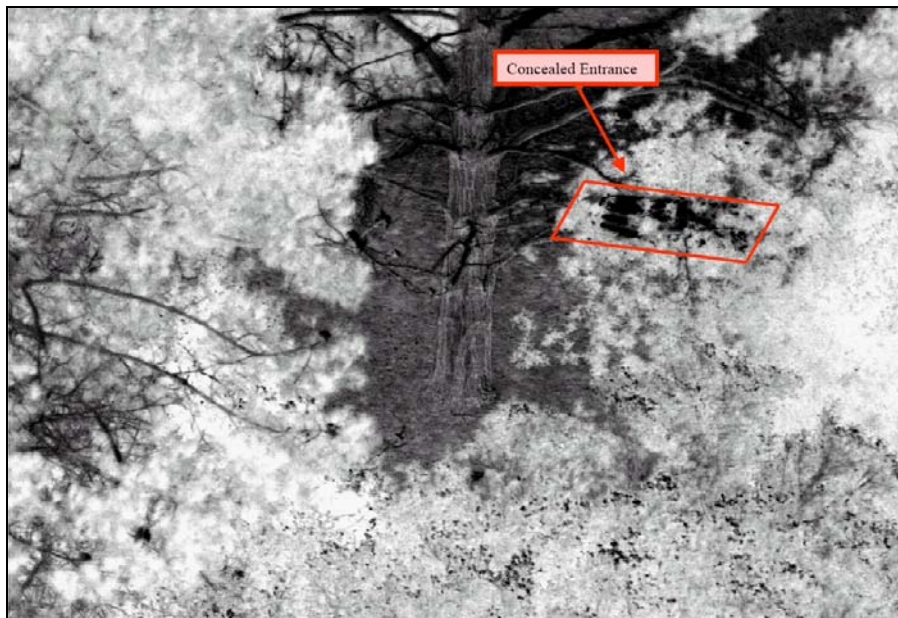

Figure 21. Wooded Scene with Concealed Entrance with NIR enhanced

C. VEHICLES CONCEALED BY TREES AND BUSHES

The third scene below in Figures 22 and 23 demonstrates the imagery systems capability to detect vehicles hidden in dense vegetation. Some of the parked cars are somewhat visible in Figure 22 due to their light coloring and glossy finish which serves to reflect sunlight. If they were painted in flat camouflage paint it would be harder to distinguish them in this vegetation rich scene. In the NIR enhanced image the surrounding vegetation becomes a light background making it easier to detect to vehicles behind the trees and bushes, as shown in Figure 23 below.

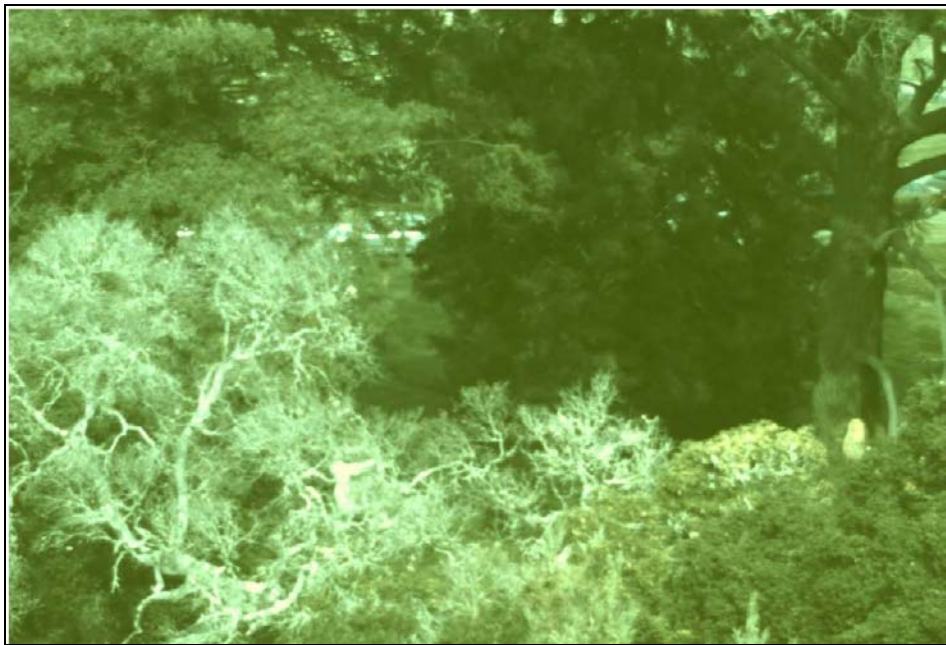

Figure 22. Vehicles Concealed by Vegetation [visible range]

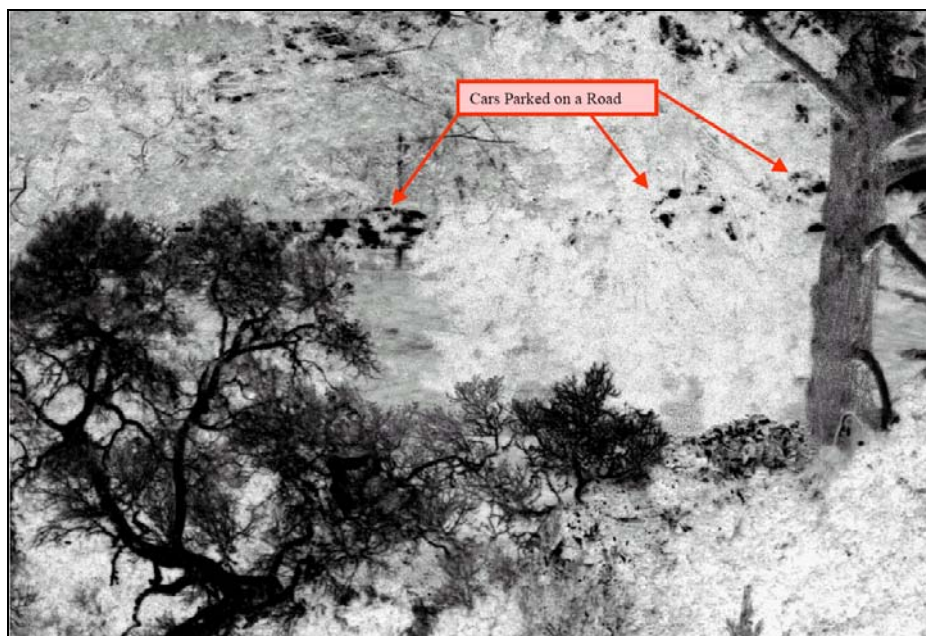

Figure 23. Vehicles Concealed by Vegetation [NIR range]

Note how the outline of the vehicles begins to emerge in the NIR enhanced image. With the use of additional imagery progressing tools it may be possible to create even more contrast between the vehicles and the background to the point where an automated detection program would be able to detect them.

VII. POTENTIAL APPLICATIONS

A. MILITARY APPLICATIONS

There is a need for an inexpensive and portable counter-CC&D sensor in the modern battlefield. As was pointed out the introduction chapter the current counter-CC&D sensors are not portable, not mature enough, or too expensive to be used in board applications across the military. The light weight and low cost of a FOVEON based counter-CC&D system makes it suitable for applications in numerous military mission areas.

1. On the Battlefield

The small size and lightweight of the FOVEON camera makes it an ideal accompany to the small ruggedized computers that are being used on today's battlefield. The Army and Marine Corps currently use computers on the battlefield in M1A2 Abrams Main Battle Tanks, in M2A3 Bradley Fighting Vehicles and as numerous handheld, tablet and notebook computers for foot soldiers applications. Some examples are depicted below.

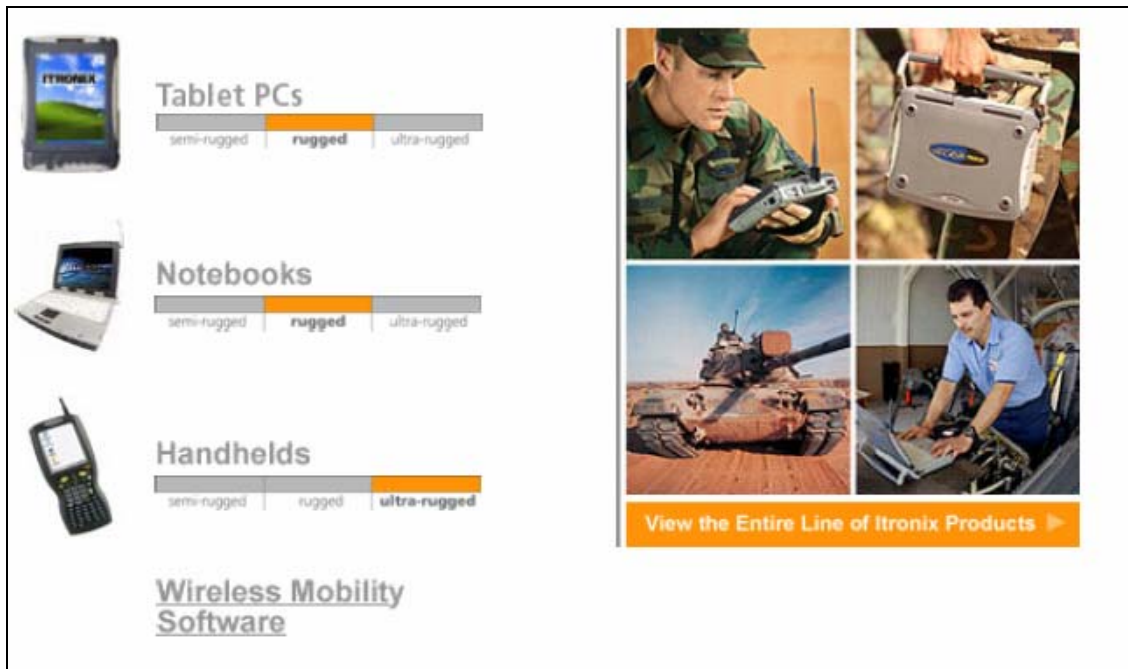

Figure 24. Samples of Military portable PCs from the Itronix Military Solutions http://www.itronix.com/industry_solutions/military.asp November 2005

Imagery sensors are currently deployed on the modern battlefield in support of the Net-Centric Warfare Concept. The goal is to provide situational awareness of the whole battlefield to every soldiers and every command center in hopes of maximizing the battle efficiency of a smaller, but more technologically enhanced fighting force. Digital video cameras are already in use to provide this situational awareness so the addition of a new piece of gear is not an issue. The replacement of some of the existing digital cameras with FOVEON cameras and the addition of another software application is all that is required to integrate the FOVEON sensor into the modern battlefield. The FOVEON camera is small enough to be helmet mounted and have the video signal fed back to a remote computer for analysis.

2. Aerial Reconnaissance

The FOVEON camera can also be used to replace the digital camera in a UAV or manned reconnaissance aircraft. Due to the unique triple well Photodetector design the FOVEON camera has three times the image resolution of a normal digital camera with the same amount of pixels so upgrading to the FOVEON camera will significantly improve the normal picture quality. With some simple modifications the FOVEON camera could easily function both as a high-resolution visible range camera and as a counter-CC&D multi-spectral sensor. For the UAV operation the imagery signal sent from the camera can be analyzed remotely in the same manner that is currently being used for other UAV signals.

B. CIVIL APPLICATIONS

Commercial crop growers and the National Forest Service current use multi-spectral and hyper-spectral satellite and airborne imagery to determine the health of vegetation. The acquisition of satellite and airborne imagery is costly due to the limited available and the high cost of the imaging systems and platforms. The use of a FOVEON based imagery analysis system can be a low cost alternate. In this application NDVI will be used has a direct indicator of crop health by monitoring its value. The value of NDVI ranges from -1 to $+1$, the higher the NDVI value the healthier the crop.

VIII. SUMMARY AND RECOMMENDATIONS

A. SUMMARY OF THIS RESEARCH

The research conducted in this work indicated that the FOVEON image sensor could be used in the counter-CC&D military mission area due to its ability to detect light in the NIR range. The low cost and high portability of the FOVEON sensor makes it attractive for use on the battlefield. By replacing some of the digital cameras currently being used in the military and the addition of imagery application software it is possible to add a counter-CC&D sensor to the battlefield at very little cost. This work was done using one of the earliest models of the FOVEON focal array, a 1.51 megapixels physical (effectively 4.53 megapixels, due to the triple well structure). This camera only had an 8 bit dynamic range, which gave pixel value ranging from 0 to 255 (0 to 2^8). The quality of the imagery in this research was limited by these factors. The FOVEON focal array is now available in 3.43 megapixels physical (10.29 megapixels effective) and with higher dynamic ranges. The utilization of a current FOVEON array should more than double the resolution and dynamic ranges seen in this research. The addition of a more advanced frame grabber that can provide more control of the camera's functionality will improve the quality and the ease of operation of the imagery system.

B. RECOMMENDATIONS FOR APPLICATIONS AND FOLLOW-ON STUDIES

1. Upgrade and Use in Training Exercises

Given the limitations of the early model camera used in this research work it is recommended that a later model FOVEON camera and a more advanced frame grabber be acquired and mated to the imagery exploitation system. This upgraded system should then be used against real CC&D targets. Following the successful employment against real targets it should be put into the hands of troops in a training environment. This will serve to get users feedback which can be used to modify the software and hardware to improve its performance.

2. Conduct Further Research to Exploit the NUV Detection Range

The FOVEON sensor was shown in Cheak [4] to detect near-ultra violet light (200 – 400 nm). Further study is needed to understand and find potential uses for the focal array in this range. Exploiting the UV absorption characteristics of vegetation as compared to that of non-vegetation can add another tool for detecting man-made targets in vegetation rich environment.

3. Use of Multiple Spectral Band Pass Filters to Narrow Detection Ranges

With the addition of multiple narrow band pass spectral filters the spectral range of the FOVEON sensor of 200 nm to 1100 nm would be broken into narrows bands to enable further exploitation of the deferential reflectance of objects in the image scene. As was shown in Figure 11, the plot of the spectral reflectance of various man-made and natural materials, each material has a unique spectral reflectance signature. With narrower spectral filters it may be possible detect specific materials in a scene.

APPENDIX A - REFERENCE PHOTODIODE RESPONSIVITY VALUES AND CURVE

Below are the calibrated responsivity values and curve for the reference silicon photodiode that was provided by the manufacturer that was used in the characterization of the FOVEON sensor.

Wavelength	Responsivity (A/W)	Wavelength	Responsivity (A/W)	Wavelength	Responsivity (A/W)
200	0.07	500	0.242	800	0.418
210	0.078	510	0.25	810	0.423
220	0.084	520	0.256	820	0.429
230	0.09	530	0.262	830	0.435
240	0.094	540	0.268	840	0.44
250	0.089	550	0.275	850	0.445
260	0.082	560	0.281	860	0.45
270	0.076	570	0.288	870	0.455
280	0.078	580	0.294	880	0.46
290	0.087	590	0.3	890	0.464
300	0.099	600	0.305	900	0.472
310	0.106	610	0.31	910	0.477
320	0.11	620	0.315	920	0.481
330	0.113	630	0.322	930	0.486
340	0.115	640	0.329	940	0.491
350	0.101	650	0.334	950	0.494
360	0.102	660	0.34	960	0.499
370	0.104	670	0.346	970	0.499
380	0.114	680	0.351	980	0.501
390	0.131	690	0.357	990	0.496
400	0.147	700	0.361	1000	0.487
410	0.161	710	0.367	1010	0.472
420	0.174	720	0.373	1020	0.447
430	0.185	730	0.379	1030	0.413
440	0.194	740	0.384	1040	0.369
450	0.204	750	0.39	1050	0.318
460	0.212	760	0.396	1060	0.262
470	0.221	770	0.402	1070	0.216
480	0.229	780	0.407	1080	0.18
490	0.236	790	0.412	1090	0.149
				1100	0.121

Table 1. Reference Silicon Photodiode Model UV-035D Calibration Table

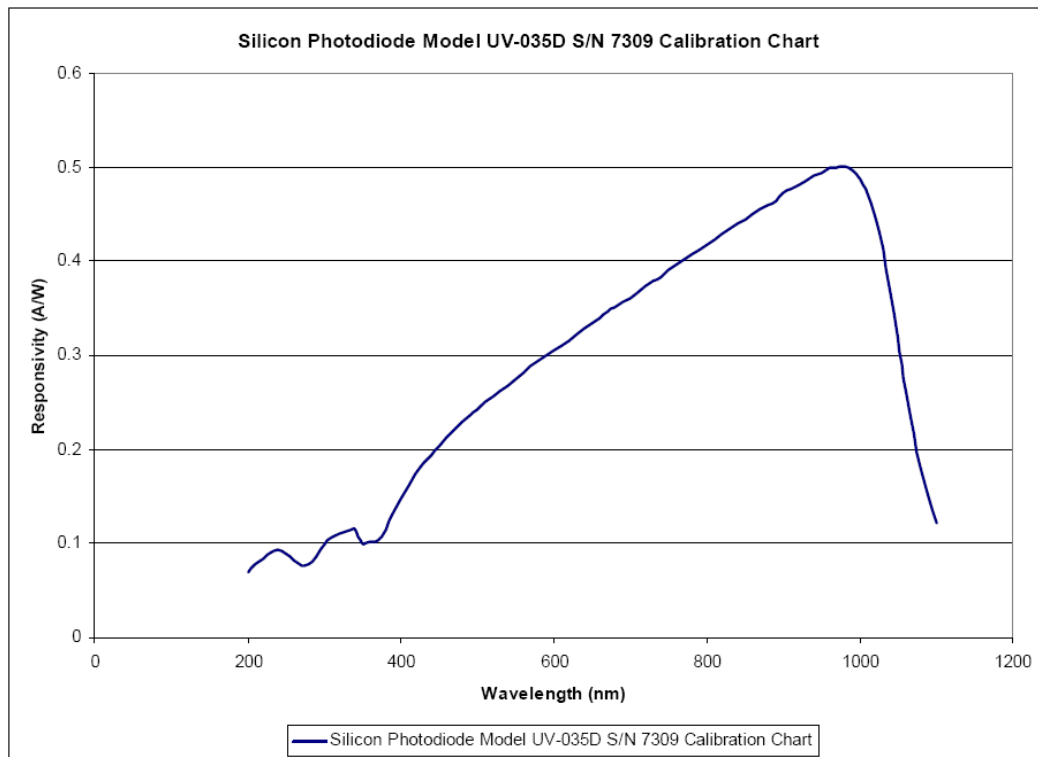

Figure 25. Reference Silicon Photodiode Model UV-035D Calibration Chart

APPENDIX B - CHARACTERIZATION MEASUREMENTS OF THE REFERENCE PHOTODIODE

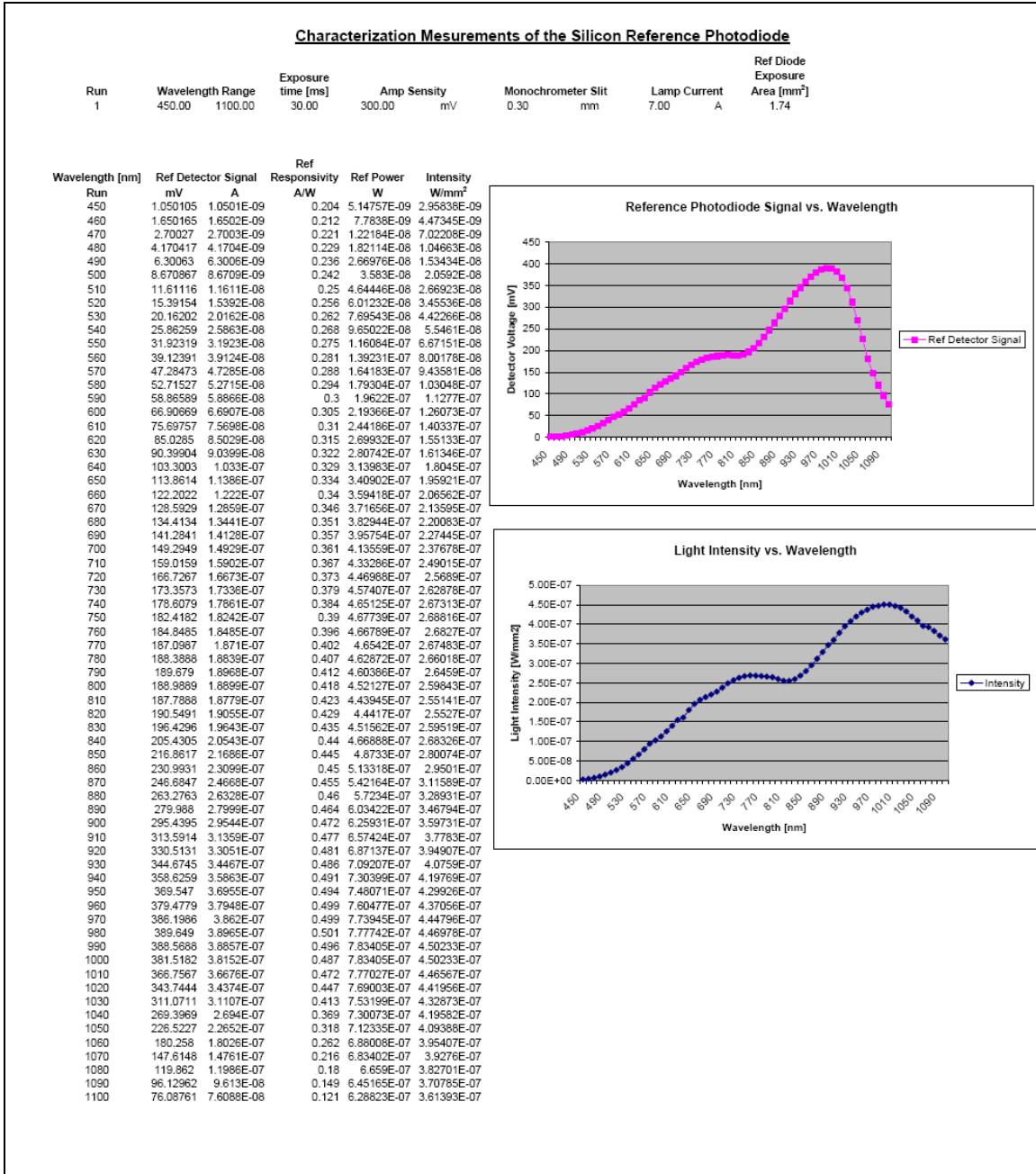

Table 2. Characterization Values for the Reference Photodiode

THIS PAGE INTENTIONALLY LEFT BLANK

APPENDIX C – CHARACTERIZATION MEASUREMENTS OF THE FOVEON IMAGE SENSOR

Characterization Measurements of the FOVEON Image Sensor												
Run	Wavelength Range		Exposure time [ms]	Amp Sensity	Monochrometer Slit		Lamp Current	FOVEON Pixel Area				
1	450.00	1100.00	30.00	300.00 mV	0.30	mm	7.00 A	8.32E-05 [mm ²]				
Run	Wavelength [nm]	FOVEON Detector Reading			FOVEON Detector Singal [V]			Intensity W/mm ²	FOVEON Power W	FOV Responsivity [A/W]		
		R	G	B	R	G	B		W	R	G	B
450	0	5	20	0	0.0976563	0.390625	2.95838E-09	2.46137E-13	0	3.988E+11	1.58702E+12	
460	5	10	30	0.0976563	0.1953125	0.585938	4.47345E-09	3.72191E-13	2.62382E+11	5.248E+11	1.57429E+12	
470	5	15	35	0.0976563	0.2929688	0.683594	7.02208E-09	5.84237E-13	1.67152E+11	5.015E+11	1.17006E+12	
480	10	20	40	0.1953125	0.390625	0.78125	1.04683E-08	8.70799E-13	2.24291E+11	4.486E+11	8.97164E+11	
490	15	30	40	0.2929688	0.5859375	0.78125	1.53434E-08	1.27657E-12	2.29496E+11	4.59E+11	6.1199E+11	
500	20	45	50	0.390625	0.6790063	0.976563	2.0592E-08	1.71325E-12	2.28002E+11	5.13E+11	5.70005E+11	
510	30	60	60	0.5859375	1.171875	1.171875	2.66923E-08	2.2208E-12	2.63841E+11	5.277E+11	5.27681E+11	
520	35	65	63	0.6835938	1.2695313	1.230469	3.45536E-08	2.67486E-12	2.37784E+11	4.416E+11	4.2801E+11	
530	45	75	70	0.8789063	1.4648438	1.367188	4.42266E-08	3.67965E-12	2.38856E+11	3.961E+11	3.71553E+11	
540	60	95	88	1.171875	1.8554688	1.71875	5.5461E-08	4.61436E-12	2.53963E+11	4.021E+11	3.72479E+11	
550	70	105	95	1.3671875	2.0507613	1.855469	6.67151E-08	5.5507E-12	2.46309E+11	3.695E+11	3.34277E+11	
560	95	120	95	1.8554688	2.34375	1.855469	8.00178E-08	6.65748E-12	2.78704E+11	3.52E+11	2.78704E+11	
570	100	130	95	1.953125	2.5390625	1.855469	9.43581E-08	7.85059E-12	2.48787E+11	3.234E+11	2.36348E+11	
580	120	130	95	2.34375	2.5390625	1.855469	1.03048E-07	8.6736E-12	2.73388E+11	2.981E+11	2.16417E+11	
590	130	135	95	2.5390625	2.6367188	1.855469	1.1277E-07	9.36248E-12	2.70618E+11	2.81E+11	1.97759E+11	
600	130	130	95	2.5390625	2.5390625	1.855469	1.26073E-07	1.04892E-11	2.42064E+11	2.421E+11	1.76893E+11	
610	132	125	85	2.578125	2.4414063	1.660156	1.40337E-07	1.1676E-11	2.20805E+11	2.091E+11	1.42185E+11	
620	160	140	95	3.125	2.734375	1.855469	1.55133E-07	1.26071E-11	2.42115E+11	2.119E+11	1.43759E+11	
630	162	130	90	3.1640625	2.5390625	1.757913	1.61346E-07	1.3424E-11	2.35702E+11	1.891E+11	1.30945E+11	
640	192	155	105	3.75	3.0273438	2.050781	1.8045E-07	1.50134E-11	2.49778E+11	2.016E+11	1.36599E+11	
650	188	138	100	3.671875	2.6953125	1.953125	1.85921E-07	1.63006E-11	2.2526E+11	1.654E+11	1.19819E+11	
660	192	128	105	3.75	2.5	2.050781	2.06962E-07	1.7180E-11	2.18201E+11	1.465E+11	1.19329E+11	
670	194	145	100	3.7890625	2.8320313	1.953125	2.13596E-07	1.77711E-11	2.13215E+11	1.594E+11	1.09904E+11	
680	202	150	100	3.9453125	2.9296875	1.953125	2.20083E-07	1.83109E-11	2.15463E+11	1.6E+11	1.06665E+11	
690	240	165	110	4.6875	3.2226563	2.148438	2.27446E-07	1.86234E-11	2.47709E+11	1.703E+11	1.13533E+11	
700	222	148	95	4.3359375	2.890625	1.855469	2.37678E-07	1.97748E-11	2.19266E+11	1.462E+11	93830003383	
710	240	165	106	4.6875	3.2226563	2.050781	2.49015E-07	2.0718E-11	2.26252E+11	1.555E+11	98985315745	
720	245	170	106	4.7851563	3.3203125	2.050781	2.5689E-07	2.13732E-11	2.23885E+11	1.553E+11	95950892408	
730	250	175	106	4.8828125	3.4179688	2.050781	2.62878E-07	2.18714E-11	2.23251E+11	1.563E+11	93785324417	
740	250	165	106	4.8828125	3.2226563	2.050781	2.67313E-07	2.22404E-11	2.19547E+11	1.449E+11	92209651095	
750	250	160	95	4.8828125	3.125	1.855469	2.68816E-07	2.23655E-11	2.18319E+11	1.397E+11	82961386026	
760	250	160	100	4.8828125	3.125	1.953125	2.6827E-07	2.232E-11	2.18764E+11	1.4E+11	87505482375	
770	250	140	80	4.8828125	2.734375	1.5625	2.67483E-07	2.22545E-11	2.19407E+11	1.229E+11	70210361681	
780	250	130	80	4.8828125	2.5390625	1.5625	2.66018E-07	2.21327E-11	2.20615E+11	1.147E+11	70568627536	
790	250	130	75	4.8828125	2.5390625	1.464844	2.6459E-07	2.20139E-11	2.21806E+11	1.153E+11	66541909261	
800	250	128	70	4.8828125	2.5	1.367188	2.59843E-07	2.16189E-11	2.25858E+11	1.166E+11	63240312009	
810	245	125	65	4.7851563	2.4414063	1.269531	2.55141E-07	2.12277E-11	2.2542E+11	1.15E+11	5680535357	
820	245	125	65	4.7851563	2.4414063	1.269531	2.5527E-07	2.12385E-11	2.25306E+11	1.15E+11	56775030446	
830	240	120	64	4.6875	2.34375	1.25	2.59519E-07	2.15919E-11	2.17095E+11	1.085E+11	57891948464	
840	195	90	60	3.8085938	1.7578125	1.171875	2.68326E-07	2.23247E-11	1.706E+11	7.874E+10	52492212213	
850	195	90	60	3.8085938	1.7578125	1.171875	2.80074E-07	2.33022E-11	1.63444E+11	7.544E+10	50290320861	
860	200	95	60	3.90625	1.8554688	1.171875	2.9501E-07	2.45449E-11	1.59147E+11	7.559E+10	4774210065	
870	220	95	60	4.296675	1.8554688	1.171875	3.11589E-07	2.59242E-11	1.65748E+11	7.157E+10	45203957783	
880	200	95	55	3.90625	1.7578125	1.074219	3.28931E-07	2.73671E-11	1.42735E+11	6.423E+10	3925258951	
890	220	95	60	4.296675	1.8554688	1.171875	3.46704E-07	2.88533E-11	1.48921E+11	6.431E+10	40814935023	
900	215	95	60	4.1992188	1.8554688	1.171875	3.59731E-07	2.99296E-11	1.40303E+11	6.199E+10	39154400991	
910	190	90	55	3.7109375	1.7578125	1.074219	3.7783E-07	3.14355E-11	1.18049E+11	5.592E+10	34172199025	
920	192	90	55	3.75	1.7578125	1.074219	3.94007E-07	3.26562E-11	1.14134E+11	5.35E+10	3264530052	
930	175	70	45	3.4179688	1.3671875	0.878906	4.0759E-07	3.39115E-11	1.00791E+11	4.032E+10	25917850486	
940	170	65	40	3.3203125	1.2695313	0.78125	4.19769E-07	3.49248E-11	95070281331	3.635E+10	22369477960	
950	170	64	40	3.3203125	1.25	0.78125	4.29926E-07	3.57698E-11	92824408205	3.465E+10	21841037225	
960	168	64	40	3.28125	1.25	0.78125	4.37056E-07	3.6363E-11	90235680119	3.438E+10	21484733362	
970	169	64	40	3.3007813	1.25	0.78125	4.44786E-07	3.7007E-11	89183356434	3.378E+10	21110853594	
980	135	62	35	2.6367188	1.2109375	0.683594	4.46978E-07	3.71886E-11	70901257590	3.256E+10	18381607523	
990	128	60	32	2.5	1.171875	0.625	4.50233E-07	3.74594E-11	66738989805	3.128E+10	16884747401	
1000	108	50	30	2.109375	0.676625	0.585938	4.50233E-07	3.74594E-11	56311029207	2.607E+10	15641952558	
1010	103	45	28	2.0117188	0.6789063	0.546875	4.46867E-07	3.71544E-11	54144849152	2.366E+10	14718988119	
1020	85	40	25	1.6601563	0.78125	0.488281	4.41966E-07	3.67707E-11	45148880847	2.125E+10	13279076720	
1030	75	38	25	1.4648438	0.7421875	0.488281	4.32873E-07	3.6015E-11	40673130743	2.061E+10	13557710248	
1040	65	35	20	1.2695313	0.6835938	0.390625	4.19682E-07	3.49092E-11	36366627003	1.958E+10	11189731386	
1050	50	30	18	0.9765625	0.5859375	0.351563	4.09388E-07	3.40611E-11	28670807162	1.72E+10	10321526578	
1060	48	25	15	0.9375	0.4882813	0.292969	3.95407E-07	3.28978E-11	28497310796	1.484E+10	8905409624	
1070	45	20	10	0.8789063	0.390625	0.195313	3.9276E-07	3.26776E-11	28896293684	1.195E+10	5979954152	
1080	40	15	10	0.78125	0.2929688	0.195313	3.82701E-07	3.18407E-11	24536182622	9.201E+09	6134045655	
1090	40	10	10	0.78125	0.1953125	0.195313	3.70785E-07	3.08493E-11	25324741048	6.331E+09	6331185262	
1100	35	5	5	0.6835938	0.0976563	0.097656	3.61393E-07	3.00679E-11	22735025438	3.248E+09	3247800777	

Table 3. Characterization values for the FOVEON Sensor

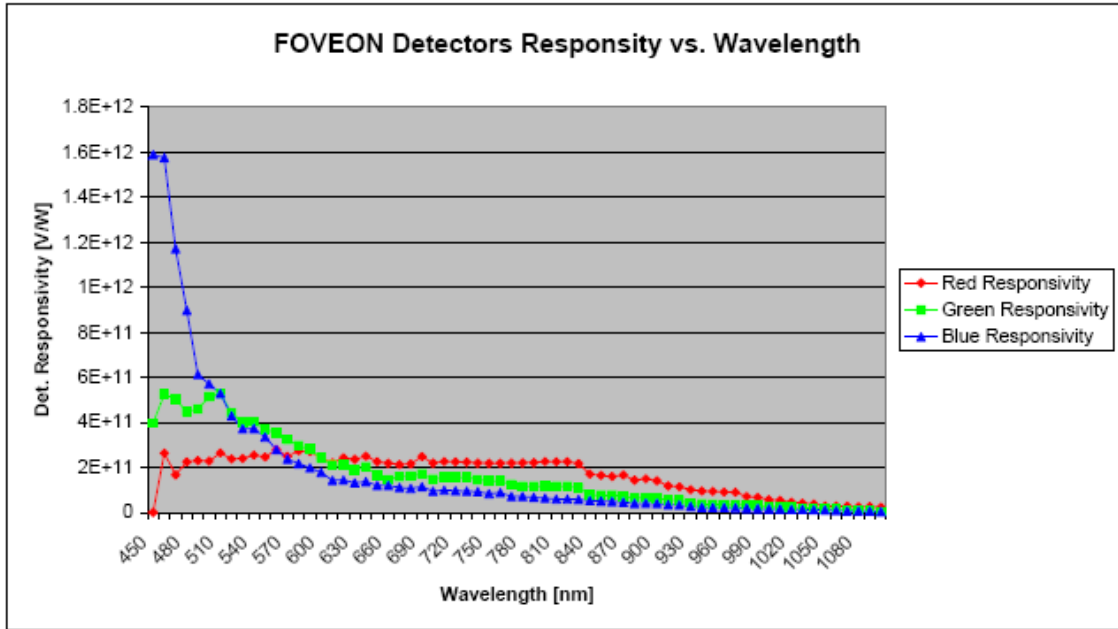
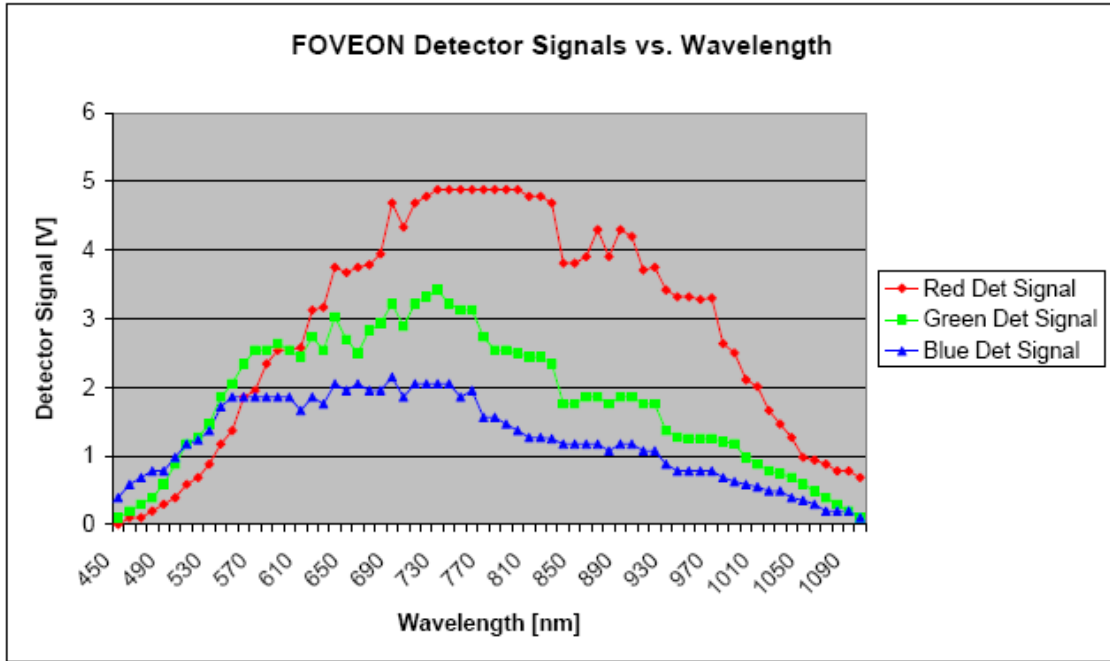

Figure 26. FOVEON Sensor Signals vs. wavelength [above], FOVEON Sensor Responsivity vs. wavelength [below]

APPENDIX D – FRAMELINK FRAME-GRABBER FOVEON SPECIFICATION

[Camera]	SrcX=0	Filter=0	InvertDV=0
Manufacturer=Han Vision	SrcY=0	PLLMode=0x0	InvertLV=0
Model=HVDUO	Fast=0	MDivisor=0	InvertFV=0
Description=Foveon Camera	HBlankStart=0	NDivisor=0	
Switches=	HBlankEnd=0	LinesPerFrame=0	
Setup=	VBlankStart=0	BitDepth=24	
[Video]	VBlankEnd=0	LineScan=0	
Version=0	PLLClockDivisor=0	CameraCtrl=0	
RGB=2	ClampLevel=0	ReverseTap=0	
XRes=1422	TriggerDirection=0x0	TapOrder=1	
YRes=1068	Outputs=0x0	PALFieldOrder=0	
AsyncTrigger=0	Iris=0	BayerMode=1	
HSyncSource=0	NonInterlaced=1	BaudRate=9600	
HSyncPolarity=0	LteWait=0	IgnoreDV=0	
ADClockSource=0	LteTime=0	RedGain=0	
VSyncSource=0	LteMaster=0	GreenGain=0	
VSyncPolarity=0	LteFrames=0	BlueGain=0	

Table 4. The Frame-Grabber Specification for the FOVEON Camera

THIS PAGE INTENTIONALLY LEFT BLANK

APPENDIX E – IDL PROGRAM TO DETECT NON-VEGETATION

{Note comment lines are in green with “;” in front, all other lines are code}

```
; An IDL® program to extract NIR information from a FOVEON image and  
calculates
```

```
; NDVI and display areas in the image that are most probable non-vegetation.
```

```
;Define input and output directories'
```

```
dir = 'S:\Foveon\outside\test'
```

```
output_dir = dir+'\Output_Files'
```

```
CD, dir
```

```
;Routine to find and load image files from the input directory. Activate either this  
;routine of user select routine below
```

```
;file = FILE_SEARCH('* .tif')           {note need to remove “;” to activate line}
```

```
;image = READ_TIFF(file)               {note need to remove “;” to activate line}
```

```
;Routine to have user select the input image file
```

```
file = dialog_pickfile()               {note need to add “;” to de-activate line}
```

```
image = read_tiff(file)                {note need to add “;” to de-activate line}
```

```
;Size and display input image
```

```
image = image(*,*,0:1058)
```

```
nx = 1422
```

```
ny = 1058
```

```
WINDOW, 2, TITLE='Input Image', xsize = nx/3, ysize = ny/3
```

```
im = CONGRID( image, 3, nx/3, ny/3)
```

```
TV, im, true = 1, order = 1
```

```
;Create array for each color band (R,G,B)
```

```
data = float( image)
```

```
red = data(0, *, *)
```

```
green = data(1, *, *)
```

```
blue = data(2, *, *)
```

```
;Create NIR image and display it
```

```
nir = red - green
```

```
window, 0, TITLE='NIR Image', xsize = nx/3, ysize = ny/3
```

```
im_nir = bytscl(nir)
```

```
im1 = congrid( im_nir, 1, nx/3, ny/3)
```

```
tv, im1, order = 1
```

```
;Calculate and display NDVI
```

```
ndvi = (nir - red) / (nir + red)
```

```
window, 3, TITLE='NDVI', xsize = nx/3, ysize = ny/3
```

```

im_ndvi = bytscl(ndvi, min=-1, max=1)
im2 = congrid( im_ndvi, 1, nx/3, ny/3)
tv, im2, order = 1

;Calculate and display probable non-vegetation
non_veg = im_ndvi LT median(im_ndvi)
;non_veg = ndvi LT 1
window, 1, TITLE='Probable Non-Vegetation',xsize = nx/3, ysize = ny/3
im_non_veg = bytscl(non_veg, min=0, max=1)
im3 = congrid( im_non_veg, 1, nx/3, ny/3)
tv, im3, order = 1

;Output image files
cd, output_dir
write_tiff,'input.tif',reform(image)
write_tiff,'NIR.tif', reform(im1)
write_tiff,'NDVI.tif', reform(im2)
write_tiff,'Non_veg.tif', reform(im3)

end

```

APPENDIX F – FILTER CURVE FOR THE IR TRANSMIT FILTER

Below is the transmittance curve of the infrared transmits filter use to verify that the pseudo NIR calculated from the subtracting the green band from the red band was comparable to real NIR.

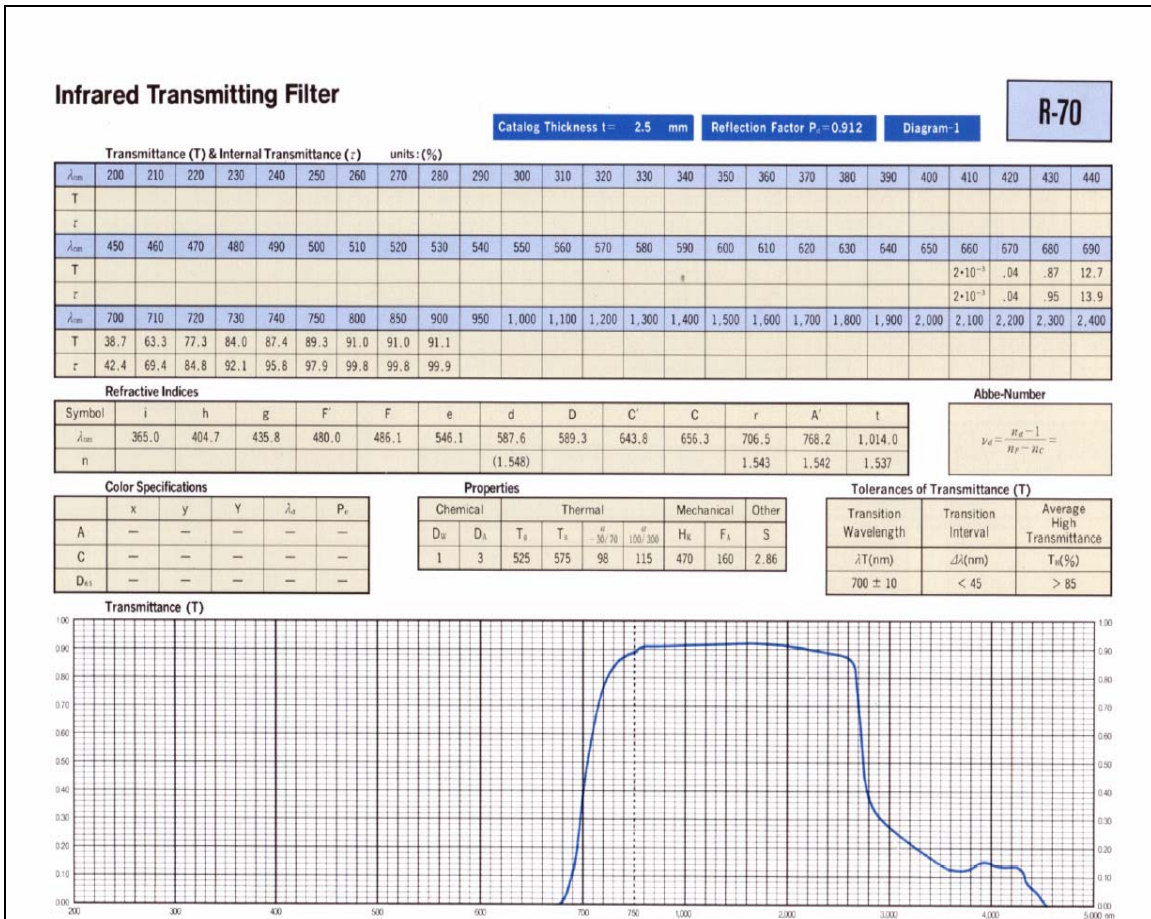

Figure 27. R-70 Infrared Transmitting Filter Curve

THIS PAGE INTENTIONALLY LEFT BLANK

LIST OF REFERENCES

1. Moyer, Lee DARPA Special Project Office CC&D PM Speech, [www.darpa.mil/DARPATech2000/Speeches/SPOSpeeches/SPOCounterConcealed\(Moyer\).doc](http://www.darpa.mil/DARPATech2000/Speeches/SPOSpeeches/SPOCounterConcealed(Moyer).doc), November 2005.
2. Pabich, Paul J. LTC, HYPERSPECTRAL IMAGERY: Warfighting Through a Different Set of Eyes, Air University Maxwell AFB.
3. Hauge, Robert, DARPA, LADAR puts the Puzzle together. <http://oemagazine.com/fromTheMagazine/apr03/pdf/ladar.pdf>, November 2005.
4. Cheak, Seck F. Detecting Near-UV and Near-IR Wavelengths with the FOVEON Image Sensor. Thesis: Naval Postgraduate School, 2004.
5. Jahne, Bernd. Digital Image Processing; Concepts, Algorithms and Scientific Applications, Fourth Edition. Springer-Verlag Berlin Heidelberg, 1997.
6. Russ, John C. The Image Processing Handbook, Second Edition. CRC Press, 1995.
7. Environment for Visualizing Images (ENVI) User's Guide, Version 4.0. Research Systems Inc. September 2003.
8. Herdlick, Bryan E. Computer-Controlled Photodetector Characterization System (Design and Construction). Thesis: Naval Postgraduate School, 2002.
9. Specifications of the Camera Link Interface Standard for Digital Cameras and Frame Grabbers, October 2000.
10. Interactive Data Language (IDL) User's Guide, Version 6.0. Research Systems Inc. July 2003.
11. IMPERX FRAMELINK™ User's Manual, DOC-0011-0002 Rev. RA03.

THIS PAGE INTENTIONALLY LEFT BLANK

BIBLIOGRAPHY

1. Cheak, Seck F. Detecting Near-UV and Near-IR Wavelengths with the FOVEON Image Sensor. Thesis: Naval Postgraduate School, 2004.
2. Jahne, Bernd. Digital Image Processing; Concepts, Algorithms and Scientific Applications, Fourth Edition. Springer-Verlag Berlin Heidelberg, 1997.
3. Russ, John C. The Image Processing Handbook, Second Edition. CRC Press, 1995.
4. Environment for Visualizing Images (ENVI) User's Guide, Version 4.0. Research Systems Inc. September 2003.
5. Herdlick, Bryan E. Computer-Controlled Photodetector Characterization System (Design And Construction). Thesis: Naval Postgraduate School, 2002.

THIS PAGE INTENTIONALLY LEFT BLANK

INITIAL DISTRIBUTION LIST

1. Defense Technical Information Center
Ft. Belvoir, Virginia
2. Dudley Knox Library
Naval Postgraduate School
Monterey, California