

# NAVAL POSTGRADUATE SCHOOL MONTEREY, CALIFORNIA

## AN *ARSENAL SHIP* DESIGN

by

LT G. Baumann, USN  
LCDR M. Chase, USN  
LT B. Ellis, USCG  
LT J. Gage, USCG  
LT T. Heatter, USN  
LT C. Mercer, USN  
LT G. Null, USN  
LT J. Sebastian, USCG

LT J. Brown, USCG  
LT D. Florence, USN  
LT M. France, USN  
LT C. Holmes, USN  
CAPT T. Langlois, USMC  
LT A. Rowe, USN  
LT J. Scrofani, USN

December 1996

Advisors:           Assoc. Prof. C. N. Calvano  
                          Assoc. Prof. R. C. Harney

NAVAL POSTGRADUATE SCHOOL



## **AN ARSENAL SHIP DESIGN**

This report documents a systems engineering and design capstone project undertaken by students in the Total Ship Systems Engineering program at the Naval Postgraduate School. The project was performed under the direction of Prof. C. N. Calvano and Prof. R. Harney. The officer students who comprised the design team were: LT G. Baumann, USN; LT J. Brown, USCG; LCDR M. Chase, USN; LT B. Ellis, USCG; LT D. Florence, USN; LT M. France, USN; LT J. Gage, USCG; LT T. Heatter, USN; LT C. Holmes, USN; CAPT T. Langlois, USMC; LT C. Mercer, USN; LT G. Null, USN; LT A. Rowe, USN; LT J. Scrofani, USN; LT J. Sebastian, USCG.

### **ABSTRACT**

The Navy's "*Arsenal Ship* Concept of Operations (CONOPS)" and "*Arsenal Ship* Capabilities Document (SCD)" address a need for the design of a large missile platform that can carry massive and precise firepower, accomplish long-range strike, and perform flexible targeting and multidimensional theater defense capabilities consistent with the policies of "Forward...From the Sea" and "Operational Maneuver from the Sea." The ship is designed to be a large missile magazine that receives its launch orders from remote air, land or sea forces. It is fully integrated into the joint command and control structure to assist current forces in the opening days of conflict. A major design goal of the *Arsenal Ship* is to limit the crew size to 50 personnel through the use of system automation, redundancy and equipment reliability, while imposing an additional constraint of limiting the sailaway price to 550 million dollars.

The Total Ship's Systems Engineering (TSSE) design team devised a design philosophy, functional analysis and flow diagrams, and a team specific *Arsenal Ship* CONOPS. These documents provided initial guidance in the selection of systems and procedures by identifying a prioritized list of design goals, and a detailed description of how the *Arsenal Ship* operates.

The preliminary design phase involved tradeoff studies to determine the optimal hull alternatives, combat system selection, and systems and procedures to reduce crew size. The *Arsenal Ship*'s hull is a modified repeat of the T-AO 201 class auxiliary ship with double hull. The selection of this hull is based partly on mass tonnage for survivability, carrying capacity for approximately 500 vertical launched missiles, and budget constraints that preclude a new hull design. The midship section of the ship is fitted with 64 8-cell Vertical Launch System (VLS) modules. The Cooperative Engagement Capability (CEC) was researched and implemented into the design to provide the controlling platform the ability to remotely fire the *Arsenal Ship*'s missiles. System automation, remote sensors and cameras are used in every situation to benefit the design for manning reduction.

## INTRODUCTION

This is the final report for the Total Ship's Systems Engineering (TSSE) student design project of 1996. The report contains the compilation of work performed over a two quarter period from June through December of 1996. The various assignments and design products created have been integrated into this report to provide a detailed and comprehensive record of the work completed.

The Assistant Secretary of the Navy, (Research, Development, and Acquisition), Mr. John W. Douglass, approached the TSSE faculty with the task of using the TSSE program to provide a preliminary design for the *Arsenal Ship*. The *Arsenal Ship* acquisition program is unique in that civilian contractors team together and compete for the design, as well as the construction contract. The TSSE project is the only non-industry design being performed. Secretary Douglass and his staff will be given the TSSE report to be used as background information to assist them in understanding and assessing contractor submissions.

To provide a thorough investigation of the *Arsenal Ship* concept, the TSSE team was divided into three teams: Hull, Mechanical, and Electrical (HM&E), Operations, and Combat Systems. The project included the following major design phases:

- (1) Design Philosophy
- (2) Functional Analysis and Concept of Operations
- (3) Hull, Mechanical, and Electrical Tradeoff Studies
- (4) Combat System Concept of Design and Tradeoff Studies
- (5) Preliminary Design, Crew Reduction and Cost Analyses
- (6) Design Evaluation

The following report contains the TSSE design team's analysis and drawings of the *Arsenal Ship*'s preliminary design. We believe that the at-sea experience and thorough analysis from the officer's involved has resulted in a sensible design of a creative and highly realistic solution to the Navy's call for an *Arsenal Ship* of the 21<sup>st</sup> Century.

## TABLE OF CONTENTS

<b>I. ARSENAL SHIP CONCEPT OF OPERATIONS.....</b>	<b>1</b>
A. INTRODUCTION.....	1
1. Forward ...From the Sea .....	1
2. General Description of Mission and Threat .....	2
a. The Mission .....	2
b. Threat.....	3
B. CRITICAL SYSTEM CHARACTERISTICS AND CONSTRAINTS .....	4
C. ARSENAL SHIP CONCEPT OF OPERATIONS.....	6
1. Key Employment Elements .....	6
2. Basing and Ship Movement.....	7
3. Integrated Logistics Support.....	8
a. Maintenance Concept .....	8
b. Logistics Considerations.....	9
4. Manpower, Personnel and Training.....	9
5. Command and Control.....	12
6. Security .....	13
7. Interoperability and Integration with Carrier Battle Groups and Amphibious Readiness Groups .....	13
D. SUMMARY .....	15
<b>II. DESIGN PHILOSOPHY .....</b>	<b>17</b>
A. OVERVIEW .....	17
B. PRIORITY OF DESIGN CONSIDERATIONS .....	17
1. Acquisition Cost and Life Cycle Cost .....	18
2. Mission Effectiveness.....	18
3. Survivability and Self Defense .....	19
4. Reduction in Manning .....	19
5. Reliability, Maintainability and Availability.....	20
6. Commonality: Other Platforms, Commercial off the Shelf (COTS) and Exploiting other DoD investments .....	21
7. Upgradeability and Modularity.....	21
8. Minimize Maintenance .....	22
9. Environmental Impact.....	22
10. Habitability .....	23
<b>III. DESIGN FOR REDUCED MANNING .....</b>	<b>24</b>
A. INTRODUCTION.....	24
B. TRAINING CONCEPT .....	26
1. Overview.....	26
2. The <i>Arsenal Ship</i> Training Command (ASTC) .....	27
3. Crew Training Cycle.....	27

4. Individual Training Concept.....	27
a. Rating/Designator Training .....	27
b. Cross-training .....	28
5. Crew Training Concept.....	28
a. Special Detail Training .....	28
b. Fleet Integration.....	28
6. Effect on Manning .....	29
a. <i>Arsenal Ship</i> Manning .....	29
C. MAINTENANCE CONCEPT .....	29
1. Depot-Level Maintenance .....	29
2. Intermediate-Level Maintenance .....	30
3. Organizational-Level Maintenance .....	30
4. Redundant systems .....	31
5. Modularity .....	31
6. Industrial Coatings.....	32
D. SPECIAL EVOLUTIONS .....	32
1. Overview.....	32
2. Underway Replenishment.....	33
3. Helicopter Operations.....	34
4. Boat Operations .....	36
5. Sea and Anchor Detail.....	38
6. Maintenance.....	38
E. ADMINISTRATIVE CONCEPT .....	40
1. Overview.....	40
2. Administrative Concept.....	41
3. Postal Services .....	41
4. Medical and Dental Services .....	41
5. Disbursing Office.....	42
F. HABITABILITY .....	42
1. Overview.....	42
2. Messing.....	42
3. Berthing .....	43
4. Crew Services .....	44
a. Laundry .....	44
b. Ship's Store.....	44
c. Barber Services .....	44
d. Crew Recreation/Physical Fitness .....	44
e. Divine Services .....	45
G. AUTOMATION.....	45
1. Overview.....	45
2. Voyage Management System .....	45
3. Two Wire Automatic Remote Sensing Evaluation System .....	46
4. Standard Monitoring Control System .....	46
5. Damage Control System .....	47
6. Integrated Condition Assessment System.....	48
7. Local Area Networks .....	48

H. DAMAGE CONTROL .....	48
I. COMBAT SYSTEM MANNING REQUIREMENTS .....	49
1. Overview.....	49
2. Command.....	50
3. Combat Systems Officer of the Watch (CSOW).....	51
4. Communications (COMMS).....	52
5. Self Defense (SD).....	52
6. Combat System Maintenance Personnel (CSMP) .....	53
J. ENGINEERING MANNING REQUIREMENTS .....	53
1. Overview.....	53
2. Engineering Watchstanders .....	54
3. Engineering Maintenance Personnel (EMP) .....	55
K. PHYSICAL SECURITY.....	55
1. Overview.....	55
2. Threat Assessment.....	55
3. Passive Design Measures.....	56
4. At Sea Security Concept and Tactics .....	56
5. Inport Security Concept and Tactics .....	56
6. Active Design Explorations.....	57
a. Weapons Positions.....	57
b. Border Suppression System (BSS).....	57
c. Intruder Detection System (IDS) .....	58
L. WATCHSTANDING CONCEPT.....	58
<b>IV. COMBAT SYSTEMS .....</b>	<b>61</b>
A. COMBAT SYSTEMS DESIGN OVERVIEW.....	61
B. LAUNCHER SYSTEMS .....	64
1. MK-41 Vertical Launch System.....	64
2. Concentric Canister Launcher .....	65
3. Launcher Selection .....	67
C. AAW, STRIKE WARFARE AND TMBD.....	67
D. SHIP SELF DEFENSE .....	68
1. Threat Analysis.....	68
2. Detection Elements.....	70
a. AAW/ASCM Threat .....	70
b. Electronic Warfare.....	70
c. ASW Threat .....	70
3. Control.....	71
a. Ship Self-Defense System (SSDS) .....	71
b. AIEWS.....	71
4. Engagement .....	72
a. Missiles .....	72
b. Decoys .....	73
E. NAVAL SURFACE FIRE SUPPORT .....	74

1. Guns/Projectiles.....	76
2. NSFS Missiles .....	79
3. NSFS Weapon Control .....	80
4. Discussion.....	80
F. COMMAND AND CONTROL SYSTEMS .....	84
1. Command and Control Goals .....	84
2. C <sup>4</sup> Employment.....	85
3. Naval Telecommunications Automation Programs.....	87
G. COMMUNICATIONS.....	87
1. 1. External Communications Equipment.....	88
a. Long Haul Communications [44] .....	93
b. HF Communication Component Descriptions: .....	95
c. VHF/UHF Line-of-Sight Communications [44].....	104
d. VHF/UHF Antennas .....	114
e. UHF Fleet Satellite Communications (FLTSATCOM) [44].....	116
f. UHF FLTSATCOM Equipment [44].....	121
g. INMARSAT.....	123
h. SHF Satellite Communications.....	124
i. Cooperative Engagement Capability (CEC).....	126
j. EHF Satellite Communications [44] .....	127
2. Naval Telecommunications Automation Programs.....	129
3. Shipboard Technical Control Systems .....	130
4. Interior Communications .....	132
5. Copernicus Architecture.....	133
6. Communication Links.....	134
7. Beyond-line-of-sight Communications.....	135
8. SINGARS .....	135
9. <i>Arsenal Ship</i> Combat Systems Communications Protocol.....	136
H. TOPSIDE DESIGN.....	138
1. Electromagnetic Compatibility.....	138
a. Topside.....	138
b. Electromagnetic Compatibility below Topside .....	141
2. Antenna Integration .....	142
3. EMI Control in HF and VHF Systems.....	143
4. Topside Design Method.....	144
I. UNDERWAY MISSILE REPLENISHMENT .....	146
<b>V. HULL, MECHANICAL, AND ELECTRICAL .....</b>	<b>149</b>
A. HULL ALTERNATIVES .....	149
1. Warship.....	149
2. Swath, Catamaran, Trimaran, and Slice .....	150
3. Specialty Hulls.....	150
4. Semi-Submersible.....	150
5. Tanker/Cargo Carrier.....	151
B. PROPULSION PLANT SELECTION.....	152



C. PROPULSION PLANT LAYOUT .....	155
D. ELECTRICAL PLANT SELECTION.....	156
E. EXTERNAL SHIP VIEWS.....	159
<b>VI. ARRANGEMENTS.....</b>	<b>166</b>
A. INTERNAL ARRANGEMENTS.....	166
1. Deck Level Plans .....	166
a. Forward Internal Arrangements .....	166
b. Aft Internal Arrangements .....	175
B. DETAILED ARRANGEMENTS .....	180
1. Bridge Layout Drawings.....	180
2. Engineering Central Control Station Drawings.....	182
3. Combat Information Center Drawings .....	184
<b>VII. SURVIVABILITY .....</b>	<b>185</b>
A. INTRODUCTION.....	185
B. APPROACH.....	185
C. SUSCEPTIBILITY .....	186
D. VULNERABILITY.....	187
1. Redundancy and Separation .....	187
2. Passive Damage Suppression.....	188
3. Component Location and Shielding .....	189
E. DAMAGE CONTROL.....	190
F. CHEMICAL, BIOLOGICAL AND RADIOLOGICAL (CBR) .....	192
<b>VIII. NAVAL ARCHITECTURE .....</b>	<b>193</b>
A. HULL GEOMETRY.....	193
B. HYDROSTATIC CURVES .....	195
C. SECTIONAL AREA CURVE .....	196
D. HULL SUBDIVISIONS AND FLOODABLE LENGTH .....	197
E. STATIC STABILITY .....	199
F. HULL STRUCTURE .....	202
<b>IX. COST ESTIMATION .....</b>	<b>204</b>
<b>X. DISPOSAL OF WASTE AT SEA .....</b>	<b>206</b>
<b>XI. DESIGN EVALUATION.....</b>	<b>209</b>

**LIST OF REFERENCES.....212**

**APPENDIX A .....216**

**APPENDIX B .....242**

**APPENDIX C .....243**

**APPENDIX D (REMOVAL THIS APPENDIX IS REQUIRED PRIOR TO  
UNLIMITED DISTRIBUTION OF THIS DOCUMENT)ERROR! BOOKMARK NOT DEFINED.**

**INITIAL DISTRIBUTION LIST ..... ERROR! BOOKMARK NOT DEFINED.**

## LIST OF FIGURES

Figure I-1. <i>Arsenal Ship</i> Forward Operating Bases and Strategic Reach.....	7
Figure I-2: Basic Operational Cycle for an <i>Arsenal Ship</i> Squadron .....	15
Figure III-1. O&S Costs for a Typical Destroyer .....	25
Figure III-2. Typical Navy Combatant vs. Projected <i>Arsenal Ship</i> Manning for Special Evolutions.....	40
Figure IV-1: Communications For The <i>Arsenal Ship</i> .....	63
Figure IV-2: <i>Arsenal Ship</i> Combat System Summary.....	64
Figure IV-3: CCL Summarized.....	66
Figure IV-4. <i>Arsenal Ship</i> Threat Triangle.....	69
Figure IV-5: <i>Arsenal Ship</i> Self-Defense Suite .....	72
Figure IV-6. The Vertical Gun for Advanced Ships (VGAS).....	77
Figure IV-7. Communication Related Advanced Technology Demonstrations .....	89
Figure IV-8. Low Observable Multi-Function Stack Exhaust Suppressor and SATCOM Antennas .....	90
Figure IV-9. Expanded View of Low Observable Multi-Function Stack Embedded Antennas.....	90
Figure IV-10. Multi-Function Electromagnetic Radiation System (MERS) Architecture. ....	91
Figure IV-11. Advanced Enclosed Mast.....	92
Figure IV-12. Example of Integrated HF Broadband Antenna, Octagonal Orientation.....	92
Figure IV-13. AN/TRQ-42 Transmitter and Receiver .....	99
Figure IV-14. AN/URT-23(D) Transmitter .....	100
Figure IV-15. R-2368B/URR HF Receiver .....	101
Figure IV-16. Broadband Three-Wire Light Weight Communications Antenna .....	102
Figure IV-17. VHF/UHF Spectrum .....	105
Figure IV-18. SINCGARS RT-1523 Transceiver.....	108
Figure IV-19. AN/ARC-182 VHF/UHF Radio.....	109
Figure IV-20. AN/WSC-3(V)6 UHF Transceiver .....	110
Figure IV-21. AN/URC-93 VHF/UHF Transceiver .....	111
Figure IV-22. GPS antenna.....	112
Figure IV-23. Low Observable UHF Communications Antenna .....	114
Figure IV-24. Low Observable LINK 16/IFF Communications Antenna.....	115
Figure IV-25. NAVMACS Processor .....	119
Figure IV-26. SRR-1 Antenna System.....	122
Figure IV-27. AS-3429/G.....	122
Figure IV-28. AS-3018/WSC-1(V) .....	123
Figure IV-29. AN/WSC-6 SHF SATCOM Antenna.....	125
Figure IV-30. CEC Antenna Schematic .....	126
Figure IV-31. CEC Antenna Location .....	127
Figure IV-32. EHF MILSTAR Antennas.....	129
Figure IV-33. CCS Architecture .....	133
Figure IV-34. EMI Between Sources and Victims .....	144
Figure V-1: Shaft Horsepower vs. Speed.....	154
Figure V-2: <i>Arsenal Ship</i> Machinery Layout.....	155
Figure V-3: <i>Arsenal Ship</i> Main Engine Room .....	156
Figure V-4: Electrical Distribution System: 3 Primary Busses, 15 Zones .....	158
Figure V-5: Top View .....	159
Figure V-6: Forward Port Bow View .....	160
Figure V-7: Forward Stbd Bow View .....	161
Figure V-8: Aft Port Qtr View .....	162
Figure V-9: Aft Starboard Qtr View .....	163
Figure V-10: Bow View.....	164
Figure V-11: Stern View.....	165
Figure VI-1: Forward Superstructure.....	171
Figure VI-2: Main Deck Forward .....	172
Figure VI-3: Second Deck Forward.....	172

Figure VI-4: Third Deck Forward.....	173
Figure VI-5: Fourth Deck Forward.....	173
Figure VI-6: Fifth Deck Forward.....	174
Figure VI-7: Sixth Deck Forward.....	174
Figure VI-8: Main Deck Aft.....	178
Figure VI-9: Second Deck Aft.....	178
Figure VI-10: Third Deck Aft.....	179
Figure VI-11: Fourth Deck Aft.....	179
Figure VI-12: Integrated Bridge System Layout.....	180
Figure VI-13: Integrated Bridge System.....	181
Figure VI-14: Engineering Central Control Station Drawings.....	182
Figure VI-15: Engineering Central Control Station.....	183
Figure VI-16: Combat Information Center.....	184
Figure VIII-1: <i>Arsenal Ship</i> Body Plan.....	194
Figure VIII-2: Hydrostatic Curves.....	196
Figure VIII-3: Sectional Area Curve.....	197
Figure VIII-4: <i>Arsenal Ship</i> 's Floodable Length Curves.....	199
Figure VIII-5: Static Stability Curve for 100 kt Beam Winds.....	200
Figure VIII-6: Static Stability Curve for High Speed Turn.....	201
Figure VIII-7: Damaged Static Stability Curve.....	202
Figure VIII-8: <i>Arsenal Ship</i> 's Midship Section.....	203

## LIST OF TABLES

Table III-1. Typical Naval Combatant Manning for Underway Replenishment [8] .....	33
Table III-2. Projected <i>Arsenal Ship</i> Manning for Refueling at Sea Evolutions. ....	34
Table III-3. Typical Navy Combatant vs. Projected <i>Arsenal Ship</i> Manning for Helicopter Operations [10].....	36
Table III-4. Typical Navy Combatant vs. Projected <i>Arsenal Ship</i> Manning for Small Boat Operations [9]. ....	37
Table III-5. PMS requirements for Deck personnel on topside equipment.....	39
Table III-6. Combat Systems Manning Requirements .....	51
Table III-7. Engineering Manning Requirements .....	54
Table III-8. Watch, Quarter and Station Bill for Watchstanders .....	59
Table III-9. Watch, Quarter and Station Bill for Special Evolutions.....	60
Table IV-1. <i>Arsenal Ship</i> Representative NSFS Targets. ....	75
Table IV-2. Suggested <i>Arsenal Ship</i> NSFS Weapon Capabilities. ....	75
Table IV-3. Vertical Gun for Advanced Ships Advantages and Disadvantages .....	78
Table IV-4. Advantages and Disadvantages of the 5-inch Gun modifications with ERGM .....	79
Table IV-5. NSFS Cost Effective Options.....	82
Table IV-6. Gun and Missile Warhead Selections.....	83
Table IV-7. HF Communications Programs .....	94
Table IV-8. <i>Arsenal Ship</i> HF Communications Equipment.....	95
Table IV-9. LOS VHF/UHF Range versus Antenna Height.....	106
Table IV-10. SINCGARS Technical Specifications.....	108
Table IV-11. Technical Characteristics of CHBDL AN/USQ-123(V) Transceiver .....	113
Table IV-12. Fleet Satellite Communications Subsystems .....	117
Table IV-13. SHF SATCOM Advantages .....	124
Table IX-1. Combat Systems Estimated Costing Data .....	205

# I. *ARSENAL SHIP* CONCEPT OF OPERATIONS

## A. INTRODUCTION

### 1. Forward ...From the Sea

Projection of power from the sea to the land, sea control and maritime supremacy, strategic deterrence, strategic sealift, and forward naval presence: these describe the fundamental and enduring roles U. S. naval forces play in providing for our nation's security. In support of these fundamental roles, naval expeditionary forces are routinely forward-deployed, designed and trained with the objectives of preventing conflicts, controlling crises, and if called upon, fighting and winning wars. Forward-deployed naval expeditionary forces are essential elements of the fundamental roles of the U. S. Navy. These naval forces normally consist of aircraft carrier battle groups and/or amphibious readiness groups. Consistent with the Navy's strategic concept paper, *Forward ...From the Sea* [1], and the Marine Corps' concept of expeditionary warfare in *Operational Maneuver From the Sea* [2], it is envisioned that these forces will increasingly be called upon to play larger and larger roles in regional conflicts.

From peacetime presence to full joint and combined operations, the power-projection capabilities of forward naval forces must increase. As described in the Navy's paper on naval warfare in the 21st century, *2020 Vision* [3], the theater commander of the future will require massive and precise firepower, long-range strike, flexible targeting, and multi-dimensional theater defense capabilities that go beyond current levels. A concept which will provide these increased capabilities is the introduction of a new

weapons platform into the existing expeditionary force structure which enables the concentration of massive firepower with netted targeting and weapons assignment. This new weapons platform, called an *Arsenal Ship*, will essentially be a massive, remote missile and fire support magazine, linked through Cooperative Engagement Capabilities (CEC) with off-board targeting and fire control platforms engaged in the battle space. Operating under the control and umbrella of Aegis surface combatants, the *Arsenal Ship* will provide the Joint Task Force (JTF) Commander with rapid response and firepower. This can be used to blunt the attack of regional aggressors and support the build-up and maneuver of coalition land-based air and ground forces through precision strike, naval surface fire support, and theater air and missile defense.

## **2. General Description of Mission and Threat**

### **a. The Mission**

The *Arsenal Ship* is a missile laden, forward-deployed, highly automated, optimally-manned ship that possesses a high degree of built-in protection and uses the most advanced communication networks available. In concert with traditional naval expeditionary forces, the *Arsenal Ship* provides an extremely potent forward presence in peacetime. It is used as a remote magazine, linked with the fire control and command platforms of the expeditionary forces. These *Arsenal Ship* augmented forces, operating under the concepts described in *Forward ...From the Sea* and *Operational Maneuver From the Sea*, are used by the JTF Commander for missions such as the following:

Halting Invasions. The *Arsenal Ship* provides massive quantities of advanced missiles, equipped with precision-guided munitions, used to stop attacking armored forces.

Long-Range Strike. The *Arsenal Ship* provides Tomahawk cruise missiles used to attack the enemy's center of gravity -- demolishing strategic targets, air defense sites and the enemy's military infrastructure.

Littoral Warfare. Using Standard Missile Lightweight Exoatmospheric Projectile (LEAP) or Theater Anti-Air Defense (THAAD) surface to air missiles, the *Arsenal Ship* and Aegis combatants provide tactical ballistic missile defense, defense against cruise missiles, and support to air operations. Using a naval version of the Army's Advanced Tactical Missile System (ATACMS) and an advanced naval gun system, the *Arsenal Ship* provides naval fire support to forces ashore, countering enemy artillery systems and suppressing second echelon forces and air defense sites.

Conventional Deterrence. The forward-deployed *Arsenal Ship* provides conventional deterrence against regional aggression in areas vital to U.S. national interests.

## **b. Threat**

The *Arsenal Ship* would likely be employed in every major regional conflict and will be the primary means of delivering ordnance on target to slow and halt the advance of the enemy in all areas of the battlespace. Consequently, it will be considered an extremely high valued unit and most certainly a primary target of opposing forces. The threats posed by these opposing forces encompass all varieties of sea-, air-, and land-



based weapon systems. The design and employment of the *Arsenal Ship* effectively counters the threats posed by these enemy forces.

The projected threat environment in which the mission is expected to be accomplished will range from natural environmental forces, such as heavy seas and storms, to operations in littoral environments congested with mines, small attack surface craft and coastal submarines, to environments contaminated by chemical, biological and radiological (CBR) weapons. However, the greatest challenge will be operation of the *Arsenal Ship* and its interface with the sensor and targeting platforms in an environment where the electromagnetic spectrum has been denied or degraded. The desired mission of the system, as designed, is fully realizable in such environments.

## **B. CRITICAL SYSTEM CHARACTERISTICS AND CONSTRAINTS**

The Defense Advanced Research Project Agency (DARPA) provided two documents, which briefly describe the Navy's concept of operations (CONOPS) [4] and general ship capabilities (SCD) [5], that should be used as guides in developing detailed concepts of operations and designs for the *Arsenal Ship*. The goals established by these two documents require the *Arsenal Ship* design to be revolutionary in nature. The operational concept gleaned from a thorough review of the CONOPS and SCD challenges existing Navy culture and tradition. Developing a ship system that attains the goals of the CONOPS and SCD requires rethinking standard practices and beliefs, and implementing labor-saving technologies. The following are critical system characteristics and constraints which drive this revolutionary concept of operations:

- The *Arsenal Ship* has a crew numbering less than 50.

- The *Arsenal Ship* supplies massive firepower in the early phases of crisis response and control and provides naval surface fire support (NSFS) in direct tactical support of ground forces.
- The *Arsenal Ship* is not a targeting or fire control platform. It does not possess the ability to employ the offensive weapons it carries.
- The *Arsenal Ship* is capable of full-time communications with ships, aircraft, satellites and shore stations via responsive, reliable, clear and secure voice, tactical information distribution, and recorded communications. An over-the-horizon satellite link capability is provided.
- The *Arsenal Ship* possesses limited active self-defense capability. This is a function of simplicity, manning level and cost. Therefore, if unescorted, the *Arsenal Ship* would provide the enemy with a defenseless, high value target. Consequently, the *Arsenal Ship* will always be operated under the umbrella of escorts which can provide appropriate defenses.
- The *Arsenal Ship* is always available for rapid movement upon receipt of strategic warning, providing the JTF Commander flexibility in response to regional crises (total ship availability of 0.95).
- The *Arsenal Ship* is virtually unsinkable. It incorporates designs and systems which dramatically reduce susceptibility and vulnerability. These designs and systems are predominantly passive in nature and inherently make the ship difficult to detect, target and hit. In addition, if the ship is hit, it is designed to automatically, or inherently limit, and contain damage so that the ship can continue its mission.
- The *Arsenal Ship* can be fully integrated into the joint war fighting force structure, operating in both peacetime and war as an integral fleet unit within the chain of command under Joint Combatant Command (COCOM). Peacetime operational control is exercised by numbered fleet commanders. When operating under a joint task force, operational control will be exercised by the Joint Force Maritime Commander.
- A fleet of six *Arsenal Ships* will be stationed continuously forward in the SW Asia/Persian Gulf, Western Pacific and Mediterranean theaters of operation. Like the Maritime Prepositioning Force (MPF) ships, they will remain on station in support of a Unified Combatant Commander for indefinite periods without

dependence on host nation support or permission. The maintenance, logistic and training concepts are consistent with the forward operating base (FOB) concept.

- The *Arsenal Ship* is designed with systems of high reliability and very low maintenance.
- The *Arsenal Ship* is able to refuel underway via connected replenishment (CONREP) and take on stores via vertical replenishment (VERTREP).
- The *Arsenal Ship* does not possess the capability to rearm vertical launch systems underway.
- The *Arsenal Ship* is capable of transiting the Panama and Suez canals.
- The *Arsenal Ship* has a minimum sustained speed of 22 knots.

## **C. ARSENAL SHIP CONCEPT OF OPERATIONS**

### **1. Key Employment Elements**

The discussions of mission, threats and critical ship characteristics and constraints provide the foundation for the development of a concept of operations. This concept of operations addresses the various key elements necessary to operate and maintain three squadrons of two ships, forward-deployed, with near-constant availability, capable of performing the stated missions within the constraints placed on the ship design. The requirement to remain forward-deployed for indefinite periods of time with near-constant availability and radically reduced manning demands revolutionary concepts and innovative approaches to many ship functions and operations. The CONOPS addresses the following key employment elements:

- Basing and ship movement.
- Integrated logistics support.
- Manpower, personnel and training.
- Command and Control.
- Security.

- Interoperability and integration with carrier battle groups, amphibious
- Readiness groups, and joint task forces.

## 2. Basing and Ship Movement

In order for the *Arsenal Ship* to perform its mission effectively, it must be forward deployed and continuously available for the majority of its operational life. By necessity, forward operating bases within the required geographic regions must be established. They must be capable of providing the required support services to achieve the availability goals and response time, and also provide the strategic reach. The *Arsenal Ship* will utilize the forward operating bases already established for the three MPF squadrons: Diego Garcia, Guam and Ascension Island. Figure (I-1) illustrates the locations of these bases and the strategic reach and response times associated with the sustained speed requirement of 22 knots. The circles represent closure times of 7 and 14 days.

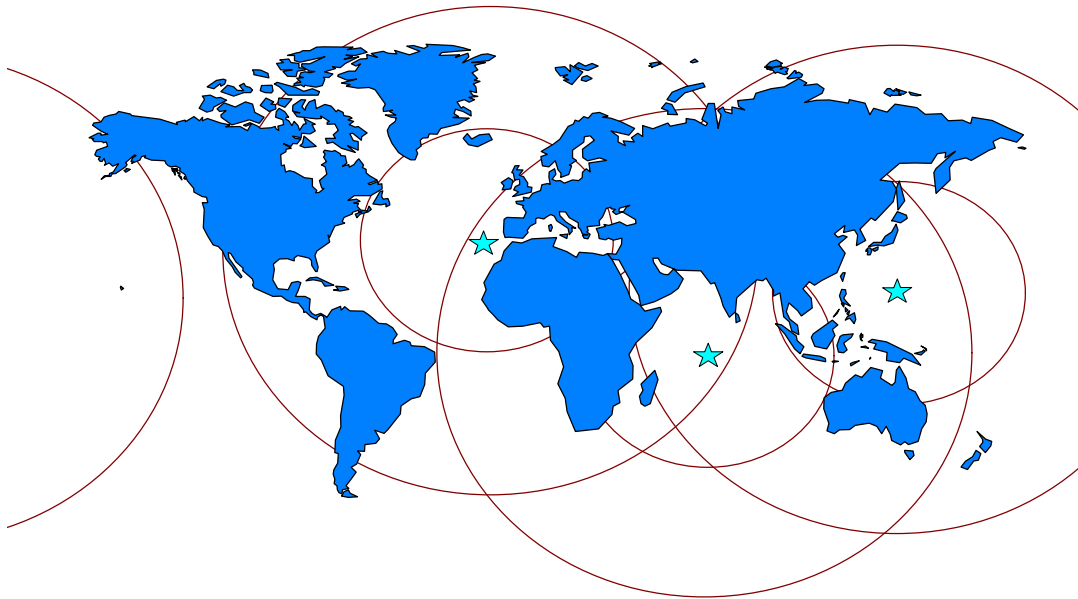

**Figure I-1. *Arsenal Ship* Forward Operating Bases and Strategic Reach**

The forward operating bases will have facilities for the maintenance and support of hundreds of missiles, to include lift, rearming and storage capabilities. All required inport logistics will be provided at these bases. All three bases have airlift capabilities that will facilitate the procurement, distribution, maintenance and replacement of materiel and personnel while the ships are inport. All organizational and intermediate level maintenance will be supported from these bases.

The *Arsenal Ship* will never be underway without appropriate escorts. Due to its limited self-defense capabilities and the high military value of its payload, the unescorted *Arsenal Ship* would present an irresistible target to potential foes. Consequently, the *Arsenal Ship* must be escorted by other fleet assets when it is moved into, out of, or within its area of operation.

### **3. Integrated Logistics Support**

#### **a. Maintenance Concept**

Maintenance requirements for the entire ship system are kept to a minimum. The requirements for a near constant availability and dramatically reduced ships force demand use of radically different systems and procedures. Organizational repair capability is minimal. Shore and afloat intermediate maintenance activities (IMA) and detachments will be used to the maximum extent possible. Ship systems are redundant, and are standardized and modular in order to capitalize on the ease and speed of "unit replacement" vice "repair-in-place" maintenance concepts. The *Arsenal Ship* is designed and will be operated such that regularly scheduled depot level maintenance is infrequent.

The *Arsenal Ship* will return from forward operations every five years for dry docking and depot level maintenance.

The upkeep of the weapons payload is minimal. Missile certifications will be performed during the regularly scheduled depot level maintenance availabilities. Routine maintenance and operational checks are eliminated and/or automated providing the readiness goals inherent in the mission concept.

**b. Logistics Considerations**

The provisioning strategy inport is much the same as for the Maritime Prepositioning Ships. The forward operating bases support airlift operations so that stores can be flown in and transported to the ship. Underway, the *Arsenal Ship* will utilize standard fleet logistic requests for provisioning via VERTREP and for underway refueling.

Storage and handling facilities for massive amounts of missiles will be required at each forward operating base. Due to the massive amount of missiles stored on both ships and the storage/handling facilities required ashore, security and safety issues are of concern.

**4. Manpower, Personnel and Training**

The normal crew size for the *Arsenal Ship* is less than 50 personnel. To achieve this, the *Arsenal Ship* employs a manning concept that parallels a typical Merchant Marine tanker, augmented with the personnel required for the military operations of the vessel. The ship makes maximum use of automation for monitoring and control of all ship functions. Damage control techniques are radically different, requiring minimal

personnel. The *Arsenal Ship* relies on passive measures incorporated into the design to inherently reduce susceptibility and vulnerability. The *Arsenal Ship*, by design, is virtually unsinkable. Fire fighting, flooding and stability control are largely automated and centrally monitored. This allows the *Arsenal Ship* to operate in combat situations with dramatically reduced numbers of personnel.

The driving factor in crew size is the manpower surge required in certain types of operations. Although it would not be unusual for a merchant vessel the size of the *Arsenal Ship* to be operated with a crew of about a dozen people, the *Arsenal Ship* is a warship and must be able to operate as such. Operations for extended periods at Condition 1 and Condition 3, refueling underway, precision anchoring, small boat operations and helicopter flight operations have all traditionally been manpower intensive. The *Arsenal Ship* is designed with innovative systems and will be operated with innovative procedures which will allow the ship to perform these functions safely and reliably with very few personnel.

The human element has not been discounted in the employment of the *Arsenal Ship*. A well trained, motivated, professional crew is the cornerstone of any weapons system. The general manning concept is closely tied to ship system design and to the maintenance concept. The ship is manned primarily by "operators." Since most of the maintenance functions are shore-based, a minimum number of maintenance-specific ratings are part of the crew. The crew focuses on training to operate and fight the ship. Constant readiness, intensive mission-specific training, and the constant routine of ship's business will be demanding with such a small crew. Personnel selected for duty in the *Arsenal Ship* program will require thorough screening, intense training and qualification, and a tireless work ethic.

The ships remain forward-deployed, with crew rotations normally taking place at the forward operating bases. In order to maintain a high level of readiness, and to respect

the spirit of the Navy's personnel management goals, the entire crew rotates as a unit. This allows for the crew to train as a unit in the continental United States (CONUS) and then deploy as a unit. The crew cycle for the *Arsenal Ship* is approximately 18 months long. Approximately six months is spent assembling and training the crew. This detailing and training phase is followed by a twelve month deployment to one of the forward-deployed ships. Due to the intense duty, as well as the forward-deployed nature of the *Arsenal Ship*, assignment to the *Arsenal Ship* program is considered a hardship assignment. Personnel are assigned to the program for approximately 18 months. This would allow for a single complete tour on an *Arsenal Ship*. A crew member will either voluntarily extend or be reassigned at the end of their tour in the *Arsenal Ship* program.

In order to achieve maximum readiness with a crew of less than 50, several conditions must be met. First, when personnel are assigned to the *Arsenal Ship* program, they must complete the cycle. Second, it is paramount that the crew members arrive at the *Arsenal Ship* proficient in their rating and qualifications. With a small crew, the individual crew members must arrive at the ship ready to do their job with a minimum amount of on-ship training. These needs are incorporated into a CONUS based "*Arsenal Ship* School." Ideally, this school would not be a new training pipeline, but a crew assembly and integration headquarters. Personnel arrive at the "school," are assigned to a crew, and are sent to existing service schools for rating specific training. *Arsenal Ship*-specific training is done at the "school" in order to qualify officers and enlisted personnel for duty on the *Arsenal Ship*.

As stated before, the crew is primarily composed of "operators." At the "*Arsenal Ship* School," the training is simulator and mockup intensive. This philosophy is carried



over to forward ports where additional simulation-based training is integrated into the ship's routine to augment the infrequent live fire exercises with other fleet assets.

The ship remains forward-deployed. Therefore, it is not available to participate in group work-ups in preparation for deployment. However, the crew, or at least a portion of the crew, is available. Through remote connectivity and existing fleet simulators, the crew links and trains with other fleet units, as if the *Arsenal Ship* is actually with the battle group. This type of training is necessary because the *Arsenal Ship* must operate as an integral part of a battle group in order to perform her mission.

## **5. Command and Control**

The *Arsenal Ship's* ability to interface with command and control systems, world wide, is the center of gravity for this platform. The most advanced communication systems are employed to create a network of sensor systems that link fire control information, in real time, back to the *Arsenal Ship*. When called upon by the targeting platforms, the *Arsenal Ship* will deliver overwhelming amounts of ordnance to a multitude of targets. Electromagnetic compatibility and frequency spectrum assignment issues are vital to the ship's ability to perform her mission. In addition, the communication and information security systems are impenetrable.

The level of connectivity required to enable the *Arsenal Ship* concept is revolutionary. This connectivity revolution is enabled through advances in Command and Control technologies married with intensive training and exercises with naval expeditionary forces. The Manpower, Personnel and Training section of the CONOPS addresses how the forward-deployed *Arsenal Ship* maintains its proficiency at interfacing

with the Command and Control architecture of the expeditionary forces which routinely work-up and deploy as integrated groups.

## **6. Security**

Due to the nature of the *Arsenal Ship's* mission and its cargo, maintaining physical security is a paramount concern. At sea, the ship must be protected from all threats that can endanger the ship and its payload. Escort ships, coupled with a sound shipboard security plan provide the measures necessary to safeguard the *Arsenal Ship* and its missiles.

The forward operating bases which support and maintain the *Arsenal Ships* require innovative security measures to protect the vital capability of these platforms. Opposing forces and terrorists on missions to damage U. S. warfighting capabilities and erode the resolve of forward-deployed forces will view these ships and the bases which support them as prime targets. The port facilities developed to service these missile laden ships must facilitate the enhanced levels of physical security required for such high valued assets.

## **7. Interoperability and Integration with Carrier Battle Groups and Amphibious Readiness Groups**

The *Arsenal Ship's* interoperability and integration with the regularly deploying naval expeditionary forces is of concern due to its forward-deployed nature of employment. The following passages and figure (I-2) describe the basic operational cycle of two *Arsenal Ships*, stationed at a designated forward operating base, in six month blocks:

- Block 1 (months 1-6):
  - *Arsenal Ship "A,"* with Crew A1, is underway in her area of operation with Group A1 (the group Crew A1 trained with prior to flying out and relieving the previous crew of ship "A").
  - *Arsenal Ship "B,"* with Crew B1, is inport at the forward operating base conducting routine maintenance on redundant ship systems and preparing for crew turnover. The ship remains available to the Unified Combatant Commander for most of her time inport.
  - Back in CONUS, Crew B2 is assembled and is training with Group B2. Prior to the end of Block 1, Crew B2 will fly to the forward operating base and relieve Crew B1.
  - Detailers are writing orders and assembling members for Crew A2.
- Block 2 (months 7-12):
  - *Arsenal Ship "B,"* with Crew B2, is underway in her area of operation with Group B2.
  - *Arsenal Ship "A,"* with Crew A1, is inport at the forward operating base conducting routine maintenance and preparing for crew turnover.
  - Back in CONUS, Crew A2 is assembled and is training with Group A2. Prior to the end of Block 2, Crew A2 will fly to the forward operating base and relieve Crew A1.
  - Detailers are writing orders and assembling members for Crew B3.
- Block 3 (months 12-18):
  - *Arsenal Ship "A,"* with Crew A2, is underway in her area of operation with Group A2.
  - *Arsenal Ship "B,"* with crew B2, is inport at the forward operating base conducting routine maintenance and preparing for crew turnover.
  - Back in CONUS, Crew B3 is assembled and is training with Group B3. Prior to the end of Block 3, Crew B3 will fly to the forward operating base and relieve Crew B2.
  - Detailers are writing orders and assembling members for Crew A3.

This operating cycle supports the operational concepts outlined above, providing two trained *Arsenal Ships* continuously available to integrate with regularly deploying naval expeditionary forces in each of the three operating areas.

	Block 1 (months 1-6)		Block 2 (months 7-12)		Block 3 (months 12-18)	
<i>Arsenal Ship A</i>	Underway with Crew A1 and Group A1.		Inport with Crew A1 at FOB conducting routine maintenance and preparing for crew turnover.	Crew Turn-over	Underway with Crew A2 and Group A2.	
<i>Arsenal Ship B</i>	Inport with Crew B1 at FOB conducting routine maintenance and preparing for crew turnover.	Crew Turn-over	Underway with Crew B2 and Group B2.		Inport with Crew B2 at FOB conducting routine maintenance and preparing for crew turnover.	
<i>Arsenal Ship "School" (in CONUS)</i>	Crew B2 is assembled and training with Group B2.	Crew B2 Flies to FOB/Group B2 Deploys	Crew A2 is assembled and training with Group A2.	Crew A2 Flies to FOB/Group A2 Deploys	Crew B3 is assembled and training with Group B3.	
<b>Detailing</b>	Detailers are writing orders and assembling Crew A2		Detailers are writing orders and assembling Crew B3.		Detailers are writing orders and assembling Crew A3	

**Figure I-2: Basic Operational Cycle for an *Arsenal Ship* Squadron**

#### D. SUMMARY

In an era that now finds the majority of U. S. military might based solely in the United States, vice overseas in regions of vital national interest, the forward-deployed naval expeditionary forces will certainly play a much larger role in the early stages of future engagements. These expeditionary forces must be shaped to meet the demands of future warfare. The forward-deployed forces of today must be augmented with larger numbers of precision-guided weapons and more robust command and control systems if they are to succeed in their roles as outlined in the Navy’s vision of future naval warfare. The *Arsenal Ship*, and the revolutionary warfare concept it enables, brings such capabilities to the fleet.

The CONOPS described above envisions a fleet of six *Arsenal Ships* capable and ready to integrate with regularly deploying expeditionary forces. The concept is fully consistent with the Navy and Marine Corps' strategic concepts of expeditionary warfare as described in the papers *Forward ...From the Sea* and *Operational Maneuver From the Sea*. The *Arsenal Ships*, together with traditional naval expeditionary forces, will provide the rapid, robust, combat-ready response critical to thwarting the advance of future regional aggressors and to shaping the battlefield so that follow-on forces can quickly and decisively win wars.

## **II. DESIGN PHILOSOPHY**

### **A. OVERVIEW**

*“A top level statement of guidance, for the design team, to assist in carrying out design tradeoffs in a consistent manner”*

Professor Charles N. Calvano, CAPT, USN (Ret)

This design philosophy provides a prioritized list of factors to be used by the design team throughout the duration of the project. Specific issues and systems in the *Arsenal Ship* design are considered and trade-offs made. In order to ensure this is a logical and consistent process, the following prioritized list of the major design issues is developed. This section outlines and provides justification of the issues considered important enough to be incorporated in the design philosophy and thereby incorporated into the design.

### **B. PRIORITY OF DESIGN CONSIDERATIONS**

1. Acquisition Cost and Life Cycle Cost
2. Mission Effectiveness
3. Survivability and Self Defense
4. Reduction in Manning
5. Reliability, Maintainability and Availability
6. Commonality: Other Platforms, Commercial off the Shelf (COTS), and Exploiting DoD Investments
7. Upgradeability and Modularity
8. Minimized Maintenance
9. Environmental Impact
10. Habitability

## **1. Acquisition Cost and Life Cycle Cost**

The acquisition cost is the only concrete requirement placed on the design team. The acquisition cost cannot exceed 550 million dollars. All other requirements are secondary and tradeable.

Cost is given the highest priority because of the “cost cap” of the program. Some may argue that placing cost ahead of military effectiveness is unimaginable, but it is the driving factor in future procurement and getting the most effective platform for the least cost.

Life cycle cost is viewed as important as acquisition cost. The life cycle cost, if not considered in early stages of design, could make operation of the vessel uneconomical in the future. For example: The number of crew is a fixed operating cost for the life of the vessel. Also, fuel economy is designed into the hull and power plant and once finalized is only a function of how many miles the ship is to be driven. Decision trade-offs are to be made considering life cycle cost in mind, to provide a less costly ship today and in the future.

## **2. Mission Effectiveness**

The primary role of the *Arsenal Ship* is to deliver a large number of missiles for other platforms to use. The priority of mission effectiveness is considered secondary only to cost. It is a focus of the design team to provide the most mission “bang” for the 550

### **3. Survivability and Self Defense**

Survivability is defined as the capability of a ship to avoid or withstand a man-made hostile environment [6]. The survivability capabilities of the *Arsenal Ship* require critical design attention. Design considerations that increase survivability should be incorporated.

The ship design should exploit the use of passive self-defense measures by reducing infrared (IR) and electromagnetic (EM) signatures and employing electronic warfare measures and decoys. Additional active weapon systems may need to be incorporated to provide additional protection. Extensive hull compartmentation, hardening and automated systems were included to help in controlling damage, keeping the ship afloat, and providing graceful degradation of systems.

These features provide a very survivable platform. However the *Arsenal Ship*, also depends on the ability of the escort ships to provide a protective umbrella and early warning of threats coming within the area of operations.

### **4. Reduction in Manning**

The design goal of the TSSE team is to limit personnel manning to 50. Manning reduction is primarily achieved through function automation in all aspects of ship operations, including ship control, engineering plant operations, damage control and warfighting operations. Good ship designs take advantage of technological innovations which replace or assist a crew member in making decisions, thereby reducing inconsistencies and human errors.



Watchstation manning levels are greatly reduced by relying on the automated systems to carryout routine, manpower intensive, duties. Manning levels for watchstation training are also reduced by automated systems, since fewer personnel are required. A reduction in training effort is a hidden benefit of automation. An adequately trained person should be able to operate the ship effectively and efficiently with the assistance of automated services.

Many skills cannot be replaced or done in a cost effective manner. The major effort will be to balance the two and create the best solution. Manning assignments will be addressed on a person by person basis. Every crew member will have to be justified and balanced against the cost of automation. Reductions in manning also provide hidden and intangible savings in the areas of reduced casualties.

## **5. Reliability, Maintainability and Availability**

The requirement to operate forward-deployed, with minimal manning, for extended periods of time, make reliability, maintainability, and availability paramount in meeting the mission. Use of onboard equipment monitoring systems to provide Condition Based Maintenance (CBM) information predicts maintenance based upon need. Reliability Based Maintenance (RBM) techniques incorporated with typical Preventative Maintenance (PMS) practices cut maintenance time, reduces the number of spare parts, improves reliability, improves system performance and reduces manning. The use of easily interchangeable spares and redundant systems also help provide additional reliability and availability of the *Arsenal Ship*.

**6. Commonality: Other Platforms, Commercial off the Shelf (COTS) and Exploiting other DoD investments**

Systems that are already in use in the Navy or other services were selected for use on the *Arsenal Ship*. The supporting infrastructure is already in place and can be tapped without additional cost. COTS items are to be chosen where DoD systems do not exist. This provides fast procurement, of spares and replacements, easy upgrading and interoperability. Systems and equipment from Aegis platforms are to be selected, wherever possible, because of the ease of obtaining spares from these escort ships.

Other DoD programs, such as “Smart Ship” are to be relied upon for information about new systems and programs to be incorporated into the *Arsenal Ship*, to reduce the need to invest in research and development funding.

**7. Upgradeability and Modularity**

Future growth and entire system upgrades are to be designed into the vessel. The ship is designed to be upgraded quickly, in order to significantly cut the cost and minimize the time and effort to upgrade. Modular designs also allow quick repairs by allowing change out vice repair in place. Locations for allowing removal of large equipment were included to limit down time for maintenance, ensuring the ability to meet the design goal of 95% availability.

A design goal of the ship is to provide space for a future gun system in the near future. The ship is designed to allow for this installation and already provides the needed supporting systems to speed the installation and prevent loss of availability.

## **8. Minimize Maintenance**

The dual challenge of increased system sophistication and decreased manning in the *Arsenal Ship* is to be accomplished by using new maintenance technology. These systems can incorporate monitoring and analysis and replace the current program of preventative and corrective maintenance. The systems identify degraded or degrading performance. Unattended embedded sensors continuously monitor the condition of all equipment. Monitoring stations record and analyze the information. Appropriate warnings and equipment shutdowns are controlled by the monitoring station. Critical maintenance items are attended to by the limited personnel onboard. Other items may be automatically scheduled for an upcoming port call and shore side technicians attend to the maintenance needs. Wherever possible all major maintenance is designed to be conducted “dockside” in short mini-availabilities, thereby lengthening the time between required drydockings to 5 + years. The reduction of longer maintenance time (drydockings) by performing needed maintenance dockside will allow the availability of the *Arsenal Ship* to remain above 95%.

It should be noted the design allows for the maintenance work to be completed by either Navy personnel or by a commercial contractor. Systems and required maintenance will be selected on their easy of use and ease of repair.

## **9. Environmental Impact**

Environmental regulations presently in force, today and those expected to be in place in the near future, are to be adhered to in the design. Great effort should go into balancing the cost and need of creating an environmentally friendly warship as reasonably

and cost effectively as possible. Systems are considered by their use of environmentally friendly materials and processes, prevention of typical waste disposal problems (trash dumping), and prevention of negative image related incidents (oil spills, smoke generation, etc.).

## **10. Habitability**

Sufficient habitability standards are considered as to provide adequate living space for all crew members without compromising morale. The need for higher habitability standards over conventional naval ships arises due to the smaller, mixed gender, and isolated crew of this minimally manned ship. The attention given to this area can be seen in large living quarters and recreational areas.

### III. DESIGN FOR REDUCED MANNING

#### A. INTRODUCTION

The design of the *Arsenal Ship* must incorporate innovative measures to reduce manning. The requirements are specified as follows:

- “To meet mission goals at affordable cost, ship design will be based on commercial practices and rely extensively on automation in engineering, damage [control], ship [control] and weapon systems to achieve a crew size of no more than 50.” [4]
- “Life Cycle Considerations. The ships are to be manned, if at all, by a Navy crew to be as small as practicable, but in any event not to exceed 50 people.” [5]

The rationale for this concept is primarily based on cost. An analysis of operating and support (O&S) costs for a typical destroyer [7] reveals that personnel costs have the most significant impact on ship affordability. This is depicted in figure (III-1), where personnel costs are shown to represent 65% of O&S expenditures. Although this percentage may not be accurate for the *Arsenal Ship*, its relative proportion is considered a reasonable approximation. Therefore, to design an affordable *Arsenal Ship*, major emphasis must be placed on manning reduction.

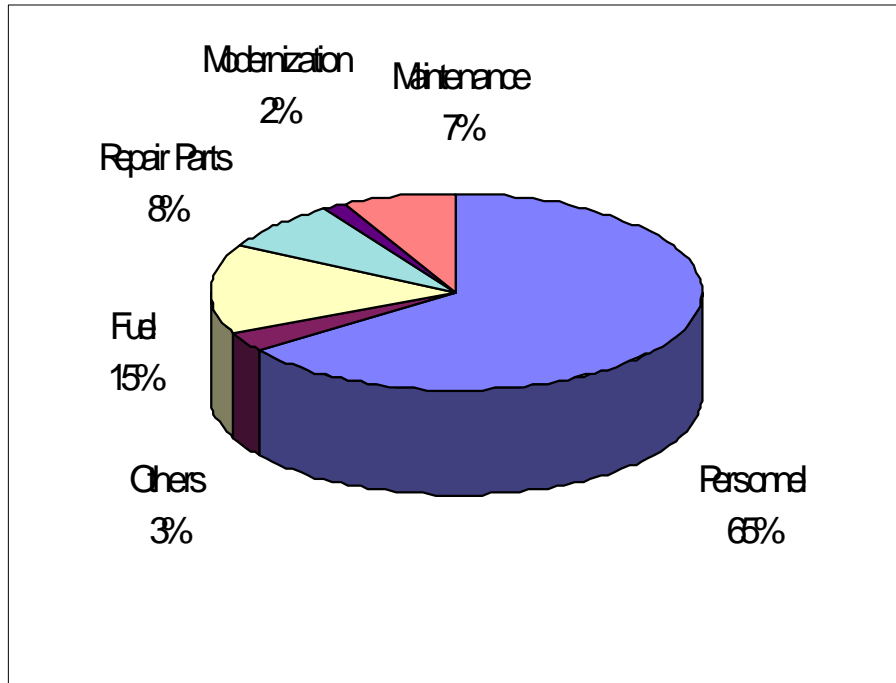

**Figure III-1. O&S Costs for a Typical Destroyer**

An additional benefit of reduced manning is the reduction of personnel placed in harm's way. By minimally manning the *Arsenal Ship*, personnel density is reduced and therefore, personnel loss due to casualty is lower.

This manning reduction is accomplished by extensive use of automation, electronics and computer technologies, as well as enacting concepts that challenge current Navy customs and traditions. These concepts or core themes are summarized as follows:

- Automation, Electronics and Computer Technologies
- Cross Functionality of Personnel
- Experience-- Professional Maturity
- Top Performers
- Selective Screening

In the design for reduced manning, extensive implementation of automation, electronics and computer technologies is required. The availability and affordability of advanced shipboard sensors and actuators, coupled with increased computer processor speeds, provide the means to effectively and safely reduce shipboard manning.

Secondly, personnel aboard the *Arsenal Ship* are required to be versatile. Cross-functionality is a crucial element to this concept of reduced manning. Crew members must not only demonstrate expertise in their area of specialty, but will be called upon to perform additional tasks, that may require additional training prior to deployment.

Additionally, a minimally manned ship requires a crew that is highly experienced. Personnel must report aboard fully trained, qualified and ready to perform at full capacity. Only self-motivated professionals are suitable for assignment to this ship.

Finally, discriminating medical, dental and psychological evaluations are required. In a manner similar to selection for submarine duty, *Arsenal Ship* personnel must be “hand-picked” for assignment. With a small, highly trained crew, personnel losses must be kept to a minimum. Selective screening is required to ensure that only “top-flight” sailors are assigned to the *Arsenal Ship*.

## **B. TRAINING CONCEPT**

### **1. Overview**

The *Arsenal Ship* reduced manning concept demands the ship be staffed with a fully mission capable crew requiring little or no onboard training. To satisfy this goal, crew members must arrive to the ship fully trained and qualified, immediately capable of performing the ship’s mission. To do this, an *Arsenal Ship* training command must be

established. This does not require a new training pipeline, but is a supplement to existing service schools with *Arsenal Ship*-specific simulator-based training.

## **2. The *Arsenal Ship* Training Command (ASTC)**

At ASTC, crews are formed and trained, and then sent as a unit to the forward-deployed ship. This command serves as administrative headquarters for the *Arsenal Ship* program, as well as the homeport for the crews. The ASTC should be located in the vicinity of existing fleet infrastructure (i.e. Norfolk, VA). This reduces the requirement for construction of administrative and support facilities.

## **3. Crew Training Cycle**

The *Arsenal Ship* training cycle is designed to build and deploy the crew as a cohesive unit. The *Arsenal Ship* cycle is approximately eighteen months in length. The first six months of the cycle are spent training the crew both as individuals and as a unit. During the next 12 months of the cycle, the crew is assigned to one of the forward-deployed *Arsenal Ships*.

## **4. Individual Training Concept**

### **a. Rating/Designator Training**

It is paramount to the reduced manning concept that each crew member on the ship is fully qualified according to billet. To accomplish this, existing service schools are used to provide initial and refresher training and qualification. This may require creation of additional *Arsenal Ship*-specific courses suited to the special needs of the program.



Additionally, existing schools may need to provide instructional and facility support to the program.

**b. Cross-training**

Crew cross-training is another cornerstone of the reduced manning concept. Crew members will perform numerous interdisciplinary tasks. Cross-training is performed along departmental lines. For example, a crew member reporting to the engineering department must be familiar with the operation and maintenance of every aspect of the engineering plant, not just his rating area. Service schools may need to develop courses to support cross-training personnel in out of rating area specialties.

**5. Crew Training Concept**

**a. Special Detail Training**

Like any other ship, special evolutions, such as underway refueling, boat operations, and flight quarters, are manning and training intensive. By locating the ASTC near an existing fleet infrastructure, land-based trainers and mockups can be used to perform team training for these special evolutions.

**b. Fleet Integration**

The *Arsenal Ship* is envisioned as a supporting platform requiring dedicated fire control support from fleet assets. Because the *Arsenal Ship* is forward-deployed and unavailable to participate in traditional battle group workups (i.e. FLEETEX, BGE), its crew must be trained in a manner similar to inport team training presently conducted at Fleet Combat Training Centers. Through remote connectivity and existing fleet simulators, the crew is able to link and train with other fleet units, as if the *Arsenal Ship*

was actually steaming with the battle group. This method of fleet integration enables the *Arsenal Ship* to remain forward-deployed while its relief crew is fully trained and integrated into the deploying battle group.

## **6. Effect on Manning**

### **a. *Arsenal Ship* Manning**

The concept of deploying trained people to forward-deployed equipment is not new, and is routinely performed in the U.S. Marine Corps. The *Arsenal Ship* adopts this concept in order to meet the requirements of steaming a minimally manned crew and an availability of 95%. Presently, crew members on naval warships are sent to schools when certain training requirements onboard are delinquent. The remaining crew members perform not only their own assignments, but also help take up the slack of their missing shipmate. The *Arsenal Ship* is already minimally manned and crew members will not be able to leave the ship for extra training once forward-deployed.

## **C. MAINTENANCE CONCEPT**

The *Arsenal Ship* is designed to operate forward-deployed for extended periods of time with minimal maintenance requirements. New methods of maintenance must be developed for this to be performed by a reduced crew.

### **1. Depot-Level Maintenance**

The *Arsenal Ship* is required to be available 95% of the time [4]. This requires no more than 18 days of unavailability for combat operations per year, or 90 days every five years. To accomplish this, most intermediate- and depot-level repairs are performed at

the forward operating bases (FOB). Access soft patches in the aft superstructure allow equipment to be easily removed and replaced requiring little more than crane service. For example, the normal lengthy overhaul of a diesel engine is reduced to a few days by removal and reinstallation of a new diesel engine, vice repair of the engine in place.

Drydocking is conducted in 90 day availabilities every five years. The driving factor for this five-year periodicity is the missile recertification requirements of the ship's payload. The *Arsenal Ship* returns to CONUS for missile offload at a Naval Weapons Station (i.e., Seal Beach, CA or Yorktown, VA) prior to entering drydock.. Upon completion of drydocking, the ship is outfitted with a fully-certified missile payload.

## **2. Intermediate-Level Maintenance**

Each FOB must have an intermediate-level maintenance activity (IMA) capable of supporting the forward-deployed *Arsenal Ships*. These IMAs are crucial in maintaining 95% availability because the ship is far removed from depot-level maintenance activities. Additionally, IMA personnel are needed to augment ship's force in performing periodic and corrective maintenance during inport periods.

## **3. Organizational-Level Maintenance**

Three different, but linked, maintenance systems are implemented in *Arsenal Ship*: Periodic Maintenance System (PMS), Reliability-Based Maintenance System (RBMS) and Condition-Based Maintenance System (CBMS) . These systems reduce unneeded maintenance. The PMS and RBMS determine maintenance requirements based upon known characteristics of installed equipment. The CBMS is a computer-based monitoring system integral to the Engineering Control and Monitoring System (ECMS).

Sensors are attached to major pieces of equipment and transmit status to the monitoring system. Baseline information recorded at equipment installation is used to determine required maintenance intervals. Significant time-intensive PMS items are replaced by the use of the CBMS. Maintenance is driven by need, vice a preset time interval. When used effectively, coordinated use of these three maintenance systems maximize availability of the ship and decrease maintenance man-hours and costs.

#### **4. Redundant systems**

A major consideration in the design of the *Arsenal Ship* is the use of redundant systems. These systems allow a shift to offline equipment in the event of failure vice immediate repair. The failed equipment can remain idle, pending repair. The equipment can then be repaired by ship's force, a technical assistance team, or by the IMA upon returning to port. Sufficient redundant systems are installed to prevent loss or degradation of any primary mission area.

Redundant systems also add to the overall survivability of the vessel. Multiple redundant systems give the ability to circumvent battle damage and restore lost functions quickly, greatly increasing survivability and ship availability.

#### **5. Modularity**

Modularity encompasses several concepts. This design incorporates two of them. The first is the use of commonality, interchangeable components in various systems. By pre-selecting common components (i.e., pumps and motors), the ability to use a single spare for multiple systems reduces required logistics infrastructure and parts storage. An

added advantage is that you can take a component from a non-vital system to replace a damaged vital system component in an emergency.

The second is the use of total modular systems. For example, each auxiliary system can be mounted on an individual skid. This concept supports the 90 day depot-level maintenance period by allowing entire systems to be swapped out, vice repaired in place. This creates a rotatable pool of well-maintained equipment to help maintain the required 95% availability of the *Arsenal Ship* fleet. Another benefit is the ability to perform configuration changes easily and quickly, keeping *Arsenal Ship* systems on the cutting edge of technology.

## **6. Industrial Coatings**

Commercially available coatings are used to the fullest extent possible to prolong the time between topside paintings. These coatings include those used on industrial machinery and submarines. This is coupled with new methods of application that make underwater coating possible, thereby extending the time between drydockings for hull inspections.

## **D. SPECIAL EVOLUTIONS**

### **1. Overview**

Special evolutions are manpower intensive aboard naval ships. The purpose of this section is to describe how the *Arsenal Ship* is designed to reduce manning for these

evolutions when compared to current practices. *Arsenal Ship* special evolutions are listed below.<sup>1</sup>

- Underway Replenishment (UNREP)
- Helicopter Operations
- Boat Operations
- Sea and Anchor Detail

## 2. Underway Replenishment

The Navy’s current methods of underway replenishment are far too manpower intensive for the *Arsenal Ship* [8]. Table III-1 shows the total number of personnel required for UNREP on a Arleigh Burke destroyer is approximately 80, depending on the number of stations involved and whether the evolution involves refueling at sea (RAS) and/or connected replenishment (CONREP) [9]. The large manpower requirement is primarily due to the need for linehandlers to pull receiving lines aboard.

1. Gunnersmate						
2. Fuel Sampler						
3-8. Phone and Distance Line						
9-22. Linehandlers for Refueling						
23-36. Linehandlers for Highline						
37-52. Rig Team						
52-62. Ready Lifeboat						

**Table III-1. Typical Naval Combatant Manning for Underway Replenishment [8]**

<sup>1</sup> NOTE: The ideas presented in this section are based on the at-sea experience of the design team, and are developed in response to the *Arsenal Ship*’s reduced manning concept. These ideas require exceptions to [8], [10] and [11].

The *Arsenal Ship* carries enough fuel for a 90 day mission such that there is no need for RAS. If RAS becomes necessary, the *Arsenal Ship* has capstans located at each refueling station in order to reduce the number of line handlers to four (Table III-2). The primary method of stores transfer to the *Arsenal Ship* is vertical replenishment (VERTREP). Wireless communications and laser rangefinders replace the phone and distance line and station-to-station phonetalkers to further reduce the manning requirement for this evolution.

Phone and Distance Line							
1. Phone Talker							
2. Linehandler							
3. Linehandler							
4. Linehandler							
5. Linehandler							
6. Gunnersmate/Signals							
7. Fuel Sampler							
8. Winch Operator							
9. Safety Observer for Winch							
10. Linehandler							
11. Linehandler							

**Table III-2. Projected *Arsenal Ship* Manning for Refueling at Sea Evolutions.**

### **3. Helicopter Operations**

Helicopter landing capabilities are critical. The helicopter is the primary means to transfer personnel (i.e., technical support personnel, medical evacuation). Since the helicopter lands on the *Arsenal Ship*, the ship has landing deck lights, tie-downs, safety nets, and a glideslope indicator.

In order to minimize manning and maximize on-station time, the *Arsenal Ship* relies on VERTREP, vice CONREP, for rapid stores transfer. The *Arsenal Ship* has a strikedown elevator in the vicinity of the flight deck to strike below stores. The

longitudinal passageways that link the fore and aft sections of the ship provide a path between the strikedown elevator and the freezer, chill box, dry provisions storeroom and ready storage spaces located forward. To move the stores from the flight deck to these storage locations, a conveyance system is installed along these longitudinal passageways.

The *Arsenal Ship* has a class-3 flight deck certification for flight deck operations [10]. Class-3 certification means the ship only provides a landing platform with no services. The decision not to carry JP-5 is based on the personnel required to maintain an additional fuel oil service and transfer system and process the fuel. Should the need arise for helicopter refueling, the escort ship or VERTREP delivery ship is responsible for providing the necessary services.

To further reduce manning during this evolution, a remotely-operated, integrated firefighting system is installed. This system includes sensors, video monitors and AFFF flight deck sprinklers. The helicopter control officer, with full visibility of the flight deck, controls activation of this system from the helicopter control station. Since this system is used to provide the initial response to a flight deck fire, the number of hose teams is reduced to one (Table III-4).



<b>Typical Naval Combatant</b>							
1-2. HIFR/Hotpump/Grounders (static discharge)							
3. Landing Signalman							
4. Helo Control Officer/comms/AFFF sprinkler operator							
5-6 Chocks/Chainmen							
7. Fire Party Scene Leader							
8. Sound Powered Phone Talker							
9-11. Plugmen/Reel Tenders							
12-17. Hosemen							
18-20. Team Leaders/Nozzlemen							
21-22. Hotsuitmen							
23-32. Ready Lifeboat Crew							
<b>Arsenal Ship</b>							
1. Landing Signalman							
2-3. Chocks/Chainmen							
4. Fire Party Scene Leader/AFFF sprinkler activator							
5. Sound Powered Phone Talker							
6. Plugman/Reel Tender							
7-8. Hosemen							
9. Team Leader/Nozzleman							
10-11. Hotsuitmen							

**Table III-3. Typical Navy Combatant vs. Projected *Arsenal Ship* Manning for Helicopter Operations [10].**

#### **4. Boat Operations**

The rigid-hull inflatable boat (RHIB) is essential for the *Arsenal Ship*. It provides additional flexibility to an already minimally manned ship. The RHIB not only serves to transport additional personnel to the ship for corrective maintenance, but also provides a ready lifeboat during certain evolutions. Requirements for the *Arsenal Ship*'s RHIB are as follows:

- The *Arsenal Ship* carries the smallest RHIB in the Navy’s inventory.
- The RHIB burns F-76 diesel fuel, marine (DFM). The *Arsenal Ship* does not carry aviation fuel (i.e., JP-5), onboard due to the additional storage and maintenance requirements, and does not carry gasoline due to the intolerably low flash point that presents a fire hazard to the ship.
- The RHIB is stowed on the main deck internal to the ship, to prevent an increase in radar cross-section (RCS).
- The *Arsenal Ship* reduces the manning for lowering and operating the RHIB as shown in Table III-4.

<b><u>Navy Combatant (lower small boat)</u></b>				<b><u>Arsenal Ship (lower small boat)</u></b>			
1. Safety Observer				1. Safety Observer			
2. Davit Captain				2. Davit Operator			
3. Davit Operator				3. Forward Linesman			
4. Forward Linesman				4. Aft Linesman			
5. Aft Linesman							
<b><u>Navy Combatant (operate boat)</u></b>				<b><u>Arsenal Ship (operate boat)</u></b>			
1. Coxswain				1. Coxswain/Bowhook			
2. Engineman				2. Engineman/Swimmer			
3. Bowhook							
4. Swimmer							
5. Boat Officer							
<b>TOTAL MANNING: 10</b>				<b>TOTAL MANNING: 6</b>			

**Table III-4. Typical Navy Combatant vs. Projected *Arsenal Ship* Manning for Small Boat Operations [9].**

During helicopter operations and underway replenishment special evolutions, the *Arsenal Ship* will not normally man a ready lifeboat. The standard procedure for these evolutions is to use a battle group asset as the primary man overboard recovery unit. This requirement stems from the fact that the *Arsenal Ship* is minimally manned, lacking extra personnel to man special evolution watch stations and a ready lifeboat simultaneously.

## **5. Sea and Anchor Detail**

The sea and anchor detail evolution is also a manning intensive operation due to the significant number of linehandlers required at each station. The *Arsenal Ship* reduces this number by positioning retractable capstans in close proximity to each station. This decreases the number of personnel required from ten per station to merely four. The four consist of a safety observer, capstan operator, and two linehandlers. The total number of personnel involved in this evolution is eight; two four-man teams, one fore and one aft. These teams, working in concert, make up two lines at a time until the ship is tied up.

A keel anchor is installed for several reasons. By removing topside equipment, the radar cross section, maintenance and preservation requirements are reduced. This reduction in maintenance and preservation requirements significantly reduces man-hours. The evolution watch is reduced from six personnel to one [9].

## **6. Maintenance**

Table III-5 contains the special evolutions PMS requirements performed at a periodicity not greater than quarterly by Deck Department personnel [11].

Boat Operations	7 PMS checks
UNREP	12 PMS checks
Helo Ops	14 PMS checks
Anchoring	2 PMS checks
Other (lifeboats, lifevests etc.)	4 PMS checks

**Table III-5. PMS requirements for Deck personnel on topside equipment.**

The majority of these PMS checks are inspections and, by shielding the equipment from the weather, the volume of corrective maintenance based on these checks is drastically reduced. The recommended deck force personnel to accomplish topside PMS and corrective maintenance is three [11].

Figure III-2 contrasts the projected *Arsenal Ship* manning requirements for special evolutions against the current Navy combatants.

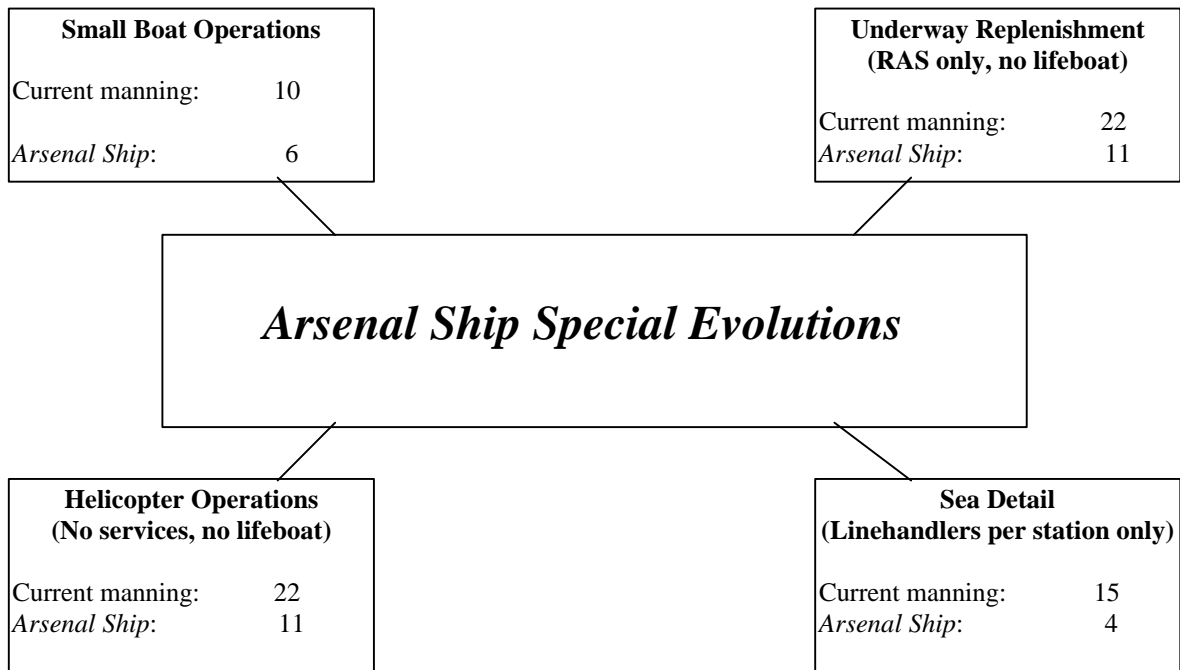

**Figure III-2. Typical Navy Combatant vs. Projected *Arsenal Ship* Manning for Special Evolutions.**

## E. ADMINISTRATIVE CONCEPT

### 1. Overview

In the past, shipboard administrative functions (i.e., service records, disbursing) have had a significant impact on manning requirements. This situation has been further exacerbated each time a new program is developed. The purpose of this section is to describe how the *Arsenal Ship* is designed to reduce manning for administrative duties onboard.

## **2. Administrative Concept**

The *Arsenal Ship* relies on computer networks to handle all administrative duties. The goal is to make the *Arsenal Ship* a “paperless” ship. The ship does not have any administrative support personnel onboard. All personnel records are maintained using the COMPASS computer program [12]. Every stateroom and berthing compartment has a computer for the ship’s crew to access the network. This allows easy exchange of fitness reports, evaluations, and training records; ordering of parts; and work order generation to all be performed on the network. A hard copy of each record is maintained at the Personnel Support Detachment (PSD) at the respective home port. All records are periodically updated via wireless transmission.

## **3. Postal Services**

A ship’s post office and postal clerk are not assigned to the *Arsenal Ship*. This is possible because electronic mail can replace paper letters. Furthermore, each crew member has access to a personal computer located in their living quarters. Additionally, all personnel receive indoctrination training on methods of electronic financial management during their six-month pre-deployment period at the ASTC. A crew member is assigned the collateral duty of mail handling.

## **4. Medical and Dental Services**

The ship has an Independent Duty Corpsman (IDC) assigned and sickbay facilities onboard. The IDC administers emergency care to the crew. All routine medical and dental examinations and procedures are performed inport at appropriate clinics. The

*Arsenal Ship* screening process discussed previously minimizes the need for medical and dental services underway.

## **5. Disbursing Office**

In addition to being paperless, the *Arsenal Ship* is also a cashless ship. The ship does not have vending machines or a traditional ship's store. All snacks and necessary laundry items are provided for each crew member. Since the *Arsenal Ship* is not expected to visit any foreign ports due to physical security requirements, there is no need for a Disbursing Officer.

## **F. HABITABILITY**

### **1. Overview**

The purpose of this section is to describe how the *Arsenal Ship* is designed to maximize the size and comfort of living arrangements for a minimal crew. This section also describes the messing concept and miscellaneous crew services.

### **2. Messing**

Two Mess Specialists (MS) are assigned to the *Arsenal Ship* to prepare and cook the meals for the entire crew. A mess attendant is assigned from the junior enlisted personnel onboard to assist the MS in preparation and cleanup of the mess and galley. The MS can use the computer in his berthing compartment to prepare the menu and automatically track the inventory of all necessary items. The entire crew pass through the buffet-style line, but dine in their own messing areas. These dining spaces include a general mess, chief petty officer' (CPO) mess, and officer's wardroom. The location of

the dining facilities and food storerooms is forward in close proximity to the primary habitability area.

### **3. Berthing**

The berthing spaces onboard the *Arsenal Ship* are designed such that all officers have individual staterooms. CPOs are assigned to two-person quarters, and enlisted personnel (E-6 and below) are assigned to six person berthing spaces. All rooms include complete head facilities. An additional benefit of this layout is that female sailors are easily accommodated. All rooms also include a television, VCR and carpeting. This “home away from home” setup is created to provide sailors a relaxing environment for their time outside normal working hours. Mess attendants are not assigned for the officer or CPO quarters due to reduced manning. All personnel are responsible for cleanliness of their living quarters.

The forward berthing spaces are designated the primary habitability area. This area includes sufficient berthing to accommodate 12 officers, 12 CPOs, and 24 other enlisted personnel. Additional berthing accommodations are located aft. This area includes sufficient berthing for five officers, four CPOs, and 24 enlisted personnel. The additional berthing not only provides for overflow, but also provides the ability to distribute their crew during wartime operations. Distributing the crew increases their survivability mitigating the effects of a single missile strike in a berthing area.



#### **4. Crew Services**

##### **a. Laundry**

The ship is designed to have a separate laundry space that includes two washing machines and two dryers. Ship's personnel are responsible for doing their own laundry. In order to reduce the need for pressing services, the standard uniform underway is fire retardant coveralls [13]. Laundry detergent and dryer sheets are provided to the crew as needed.

##### **b. Ship's Store**

The *Arsenal Ship* does not have a ship's store onboard. The crew may purchase the standard ship's ball caps and collared shirts at their home port. Crew members are required to bring any necessary items that they may need underway. This concept is the standard mode of operation for the submarine community. The *Arsenal Ship* uses this mode operation due to the reduced manning concept.

##### **c. Barber Services**

The *Arsenal Ship* does not have a barber shop onboard. Underway, personnel are not required to keep their grooming standards within regulations until the week before the ship returns to port. A crew member is then assigned as the ship's barber and cuts all

##### **d. Crew Recreation/Physical Fitness**

The ship is designed with a crew recreation room. This room is available during working hours for meetings and classroom training, and after working hours for

socializing. The ship also has a physical fitness space onboard. The space includes all of the standard state of the art equipment (i.e., weights, bicycle and stair climbers), and any desired Nautilus equipment.

**e. Divine Services**

All divine services are conducted by ship's crew members assigned as lay leaders.

**G. AUTOMATION**

**1. Overview**

The *Arsenal Ship* takes advantage of the latest technology to perform routine watchstanding procedures. The installation of a central, automated system, similar to the one used in the Smart Ship Program, is the baseline for the *Arsenal Ship* [14]. Several additional subsystems are added to improve overall system performance.

**2. Voyage Management System**

The Sperry Marine Vision 2100 Voyage Management System (VMS), with an integrated bridge, is used for navigation [15]. It is a commercially available, Windows NT based, computer navigational system, commonly referred to as the Integrated Bridge System (IBS). This system allows only two watchstanders to safely navigate the ship. The operator has full ship control, or he can allow the system to automatically control the ship by inputting selected waypoints at the keyboard. The ADG3000 autopilot subsystem keeps the ship on track by controlling the ship's course and speed. The MK 37 Gyro, SRD-421 Doppler Radar, Global Positioning System (GPS), and depth and weather sensors provide the VMS with necessary information to automatically correct the ship's

track. In autopilot, the bridge operators are only needed to monitor alarms, control casualties, establish communications, and serve as lookouts.

The VMS uses electronic charts that can be created in the chartroom using a chart digitizer, or purchased prior to deployment. Additionally, a RASCAR VT radar system provides the autopilot with a collision avoidance feature and displays radar over-layed images on the IBS console .

Additional modules provide voyage recording (i.e., blackbox recorder), docking displays, precision anchoring, man overboard monitoring, and engineering and damage control status. These features give the two watchstanders adequate information to properly handle abnormal situations without the requirement for additional personnel on the bridge.

### **3. Two Wire Automatic Remote Sensing Evaluation System**

The Two Wire Automatic Remote Sensing Evaluation System (TWARSES), coupled with remote television cameras, provide the bridge, engineering, and combat system watchstanders with complete all around visibility and interior space monitoring [16].

### **4. Standard Monitoring Control System**

The Standard Monitoring Control System (SMCS) is an integrated control and monitoring system for all shipboard machinery [17,18]. Watchstanders in the engineering control station (CCS), combat information center (CIC) and the pilothouse have displays depicting the engineering plant status. The engineer rooms are unmanned. The engineering watchstanders carry a personal information pad (PIP). The engineering watchstanders are

free to roam throughout the ship until the PIP beeps, notifying the watchstanders of an engineering casualty.

The SMCS provides graphical interface, as well as a hardcopy printout. This allows the engineering watchstander to make quick decisions affecting the status of the engineering plant. The SMCS, in conjunction with the ICAS (Integrated Condition Assessment System) and Damage Control System (DCS), is capable of complete control of the engineering plant including casualty control procedures [17-21]. The SMCS can shutdown and startup systems. It can also cross-connect systems and prevent loss of any vital equipment. The SMCS uses an open-architecture design that allows for future equipment upgrades and changes.

## **5. Damage Control System**

The DCS is a computer system that monitors and initiates controlling actions in the event of a casualty. The DCS provides real-time graphical information (i.e., stability, electrical isolation) to the control stations allowing rapid decision making. In the fully-automated mode the information is passed to the SMCS. This allows the SMCS to automatically isolate the compartment and activate installed damage control systems. The DCS does not require a dedicated watchstander. The engineering watchstander are responsible for monitoring the system's displays. The bridge and CIC watchstander can also monitor the damage control status of the ship locally, via the DCS monitor on their respective consoles.

## **6. Integrated Condition Assessment System**

The Integrated Condition Assessment System (ICAS) monitors, tracks, and provides a complete machinery-condition assessment. It is a diagnostic tool for maintenance management. By monitoring the equipment, a maintenance requirement estimate can be predicted. This reduces unneeded time-based maintenance. No watchstander are required for this system. Pending problems are reported to the engineering watchstander for maintenance scheduling.

## **7. Local Area Networks**

Zonal Local Area Networks (LANs) are interconnected with the ship's administrative LAN and provide engineering and ship control status to the consoles in CIC, CCS and the pilothouse. Each of these multi-purpose control centers are capable of duplicating the entire functions of the other two stations (i.e., CIC can monitor engineering plant status), thus increasing the survivability of the overall system. The control stations are also capable of displaying multiple system information on several displays

The automated systems described above provide for ship control and engineering monitoring with only three watchstanders.

## **H. DAMAGE CONTROL**

The *Arsenal Ship* uses a combination of automated systems to drastically reduce damage control party manning. The Damage Control System (DCS), in conjunction with the Standard Machinery Control System (SMCS), control the installed engineering and damage control systems automatically. The Two Wire Automatic Remote Sensing

Evaluation System (TWARSES) is the remote-sensing system that monitors all shipboard compartments.

The DCS continually monitors the TWARSES for problems. TWARSES sensors are located in every compartment, tank and void. The DCS can be monitored from CIC, CCS, and the bridge. This removes the requirements for a dedicated damage control watchstander.

The SMCS and DCS are capable of enacting a predetermined sequence of events in response to damage. These systems isolate the damaged compartment by closing hydraulic watertight doors surrounding the damage. Electrical and electronic equipment and ventilation to the affected space are secured in accordance with preprogrammed doctrine. Depending on the damage detected, the SMCS activates installed damage control systems. The compartment is isolated within seconds of damage detection, with no crew member action.

A highly capable, six-man damage control party arrives on scene to take additional action, if required. The damage control party is comprised of personnel from the non-watchstanding maintenance force.

## **I. COMBAT SYSTEM MANNING REQUIREMENTS**

### **1. Overview**

The *Arsenal Ship* concept strives for functionality and simplicity with minimum required manning. Integrated sensors, computers and electronics have allowed the automation of functions that previously required human monitoring and response. At the same time, solid state and digital electronics have become more reliable, longer-lasting

and require less maintenance. The assumption, based on this trend, is that electronics will only continue to improve and can be relied on for monitoring and response functions and require little intervention. The largest mechanical component of the *Arsenal Ship*'s combat suite is the Vertical Launching System (VLS). A preliminary study has been completed to determine the minimum number of personnel required to perform preventative maintenance on the MK 41 VLS [20].

The combat system watchstanding concept is two-fold, with combat system watchstanders (CSWS) and combat system maintenance personnel (CSMP). Watchstations consist of the Combat System Officer of the Watch (CSOW), Communications (COMMS), and Ship Defense (SD) (Table III-6). CSMP consist of the combined rates of Electronics Technicians (ET) and Gunner's Mate Missile (GMM). The ET rate brings electronics expertise and the GMM rate the missile, launcher and small arms expertise.

## **2. Command**

The Commanding Officer (CO) is ultimately responsible for the safety of the ship. He also ensures that the *Arsenal Ship* can carry out its combat mission. The CO can personally exercise his missile launch authority from the Combat Information Center (CIC). The CO is the only officer who can take the ship from the "weapons-tight" to "weapons-free" condition. Once the ship is placed in the "weapons-free" condition, the CSOW can be delegated the authority to launch all defensive weapons.

<u>COMMAND</u>					
CO					
XO					
-----					
<u>CSOW</u>		<u>COMMS</u>		<u>SD</u>	
O4	CSO	LDO	RM	E6	EW
O3	WO	E6	RM	E5	EW
<u>COMBAT SYSTEM MAINTENANCE</u>					
E6	ET	E5	GMM		
E6	ET	E4	GMM		
E5	ET	E4	GMM		
E5	ET	E4	GMM		
E6	GMM	E4	GMM	<u>TOTAL: 16</u>	

**Table III-6. Combat Systems Manning Requirements**

**3. Combat Systems Officer of the Watch (CSOW)**

CIC and the Communications Center are fully manned with a CSOW, COMMS and SD when the *Arsenal Ship* is in a combat area. The CSOW operates from the Advanced Tactical Weapons Control System Console (ATWCS), monitoring system and weapon statuses, selection requests, and post-fire assessment. Combat system maintenance and damage control parameters are monitored in CIC on the combat system control console. This console is identical to the SMCS in CCS and the IBS on the bridge. The CSOW may be thought of as a Local Area Network (LAN) manager, monitoring the entire combat system with the capability to access it to respond to individual casualties. The CSOW uses the system and determines the required level of casualty control. He can task maintenance personnel remotely via the personal information pad (PIP). The CSOWs stand a six-hour watch during combat operations. During peacetime operations,



the CSOWs conduct system diagnostics and review prioritized maintenance work lists, and are not required to remain in CIC.

#### **4. Communications (COMMS)**

The COMMS watchstander is responsible for ship connectivity. The COMMS watchstander ensures the proper communications plan is established, setting up and monitoring long-haul, tactical and link communications through the SACCS (Ships Automated Communications Control System). He conducts message delivery and communications system diagnostics. The COMMS watchstander stands a six-hour watch for one week, rotating with CSMP ETs to maintain a proficient operator/maintainer force. Since the COMMS watch is automated, the watchstander mainly monitors the system, such that a typical six-hour watch is not physically or mentally demanding.

#### **5. Self Defense (SD)**

The SD operator controls the ship's self-defense system. SD watchstanders stand a six-hour watch as required for ship self-defense. When manning of the self-defense system is not required, the SD watchstanders augment the CSMP. Similar to the COMMS watchbill, two CSMP ETs are also trained to stand the SD watch. The self-defense system includes the Advanced Integrated Electronic Warfare System (AIEWS), Decoy Launcher Control and the Rolling Airframe Missile (RAM) Weapon Control Panel. The SD operator receives engagement orders from the CSOW.

## **6. Combat System Maintenance Personnel (CSMP)**

CSMP have day work hours and prioritized maintenance schedules, repairing out of commission equipment first and then completing preventative maintenance. CSMP are on call 24 hours for emergent work or emergency response to casualties. CSMP are contacted by the PIP. The PIP notifies the CSMP of the system casualty and location or the need to contact with Officer of the Deck (OOD) or CSOW. CSMP receive damage control and security force training as a ready response force for ship damage and protection.

## **J. ENGINEERING MANNING REQUIREMENTS**

### **1. Overview**

In support of reducing manning, the engineering spaces are unmanned during normal steaming. The *Arsenal Ship* has an Engineering Officer of the Watch (EOOW) and an Engineering Operator (EO) in a four-section watch rotation (Table III-7). These watchstanders are not required to remain in the engineering spaces. The watchstanders carry a personal information pad (PIP). The watchstander is free to roam throughout the ship until the PIP beeps, thus notifying the watchstander of an engineering casualty. Four additional personnel are available for troubleshooting and repair of engineering casualties.

Maintenance Officer			
<u>EOOW</u>		<u>EO</u>	
E7	EN	E6	EN
E7	EN	E6	EN
E7	EM	E5	EN
E7	EM	E5	EM
<u>ENGINEERING MAINTENANCE</u>			
E6	DC	E5	EM
E6	EN	E5	DC
			<u>TOTAL: 13</u>

**Table III-7. Engineering Manning Requirements**

**2. Engineering Watchstanders**

The EOOW operates from the Standard Monitoring Control System (SMCS) console in the engineering control station (CCS) during engineering casualties. The EOOW uses the system to determine the required level of casualty control. He can task the EO and maintenance personnel remotely via the PIP. The EOOW may be thought of as a Local Area Network (LAN) manager, monitoring the entire engineering system with the capability to access it to respond to individual casualties. The SMCS allows the entire engineering plant to be monitored and controlled from any of the consoles in CIC, CCS, the pilothouse; all Local Operating Panels (LOP); and all Control and Collection Units (CCU). The digital monitor and control capability of this system is the primary justification for leaving all engineering spaces unmanned. The EO is primarily an assistant to the EOOW, and is available to provide local casualty control on engineering equipment in case the SMCS fails to take the proper controlling action.

### **3. Engineering Maintenance Personnel (EMP)**

EMP have day work hours and prioritized maintenance schedules, fixing broken equipment first and then completing preventative maintenance. EMP are on call 24 hours for emergent work or emergency response to casualties. EMP are contacted by the PIP. The PIP notifies the EMP of the system casualty and location or the need to contact the EOOW. EMP comprise the damage control party, and are involved in all special evolution details.

## **K. PHYSICAL SECURITY**

### **1. Overview**

The *Arsenal Ship* is a truly high value asset, thereby making physical security a significant concern with a reduced crew size. The *Arsenal Ship* relies mainly on passive design characteristics, augmenting traditional security practices, in the protection of the ship and its payload.<sup>2</sup>

### **2. Threat Assessment**

- At Sea Physical Security Threat
  - Hostile boarding and small boat attacks from terrorist organizations or special operations forces.
  
- Inport Physical Security Threat
  - Sabotage and deliberate attack from terrorist organizations or special operations forces.

---

<sup>2</sup> Note: A comprehensive analysis of these threats is beyond the scope of this report.

### **3. Passive Design Measures**

The central feature in the design for passive security is limited and controlled access. This is accomplished by minimizing the number of access points between the weatherdecks and the interior of the ship. The fore and aft superstructures each have two accesses. The doors can be remotely closed and locked from the bridge. The internal watertight doors are also remotely actuated and lockable, thus providing enhanced security and compartmentalization. The fore and aft armories are located in close proximity to the starboard accesses.

### **4. At Sea Security Concept and Tactics**

The *Arsenal Ship* relies on tactical evasion, high freeboard, and the formation of the security alert team (SAT) to combat at sea security threats. The SAT is comprised of the non-watchstanding maintenance personnel. They immediately man the armories during security alert, and arm themselves with small arms and stinger missiles. The escort ship's five inch and 50 caliber guns provide the first layer of defense against potential small boat and helicopter attacks. The *Arsenal Ship*'s rolling airframe missiles (RAM) are the second layer of attack against helicopter attacks. The final layer of defense against incoming boat and helicopter attacks is the SAT.

### **5. Inport Security Concept and Tactics**

Inport, the *Arsenal Ship* is protected by existing shore-based security forces. TWARESES assists the security forces by monitoring interior spaces using infrared (IR) sensors. There are existing security forces in place to provide pierside and port security at

the three forward operating bases. It is beyond the scope of this report to estimate the effect of basing *Arsenal Ships* at these locations.

## **6. Active Design Explorations**

The design team explored additional active security measures. They are used to give the SAT sufficient time to obtain weapons from the armories, and provide additional protection to support the reduced manning concept. The systems **were not** included in this overall design because they are drastically different from current security alert procedures and are untested.

### **a. Weapons Positions**

Armored gun tubs are placed on the weatherdecks surrounding the fore and aft superstructures. The SAT mans the tubs with small arms, 50-caliber machine guns, and stinger missiles. These tubs are positioned to place grazing fire over the weatherdeck of the ship and to provide close-in fields of fire around the superstructures.

### **b. Border Suppression System (BSS)**

A systems of command-detonated anti-personnel mines (i.e., naval variants of the M18A1 and M14 anti-personnel land mines) are placed flush with the weatherdecks (M14) and recessed into the superstructure (M18A1). These mines are positioned to cover the weatherdecks with overlapping casualty producing zones. The mines are controlled from the bridge and provide immediate response to a hostile boarding, giving the SAT time to react to the threat.

**c. Intruder Detection System (IDS)**

A key feature to the physical security system inside the ship is an IDS [22]. The IDS is integrated with TWARESES. An intruder is sensed by the TWARESES IR sensors. A signal is sent to the IDS. The IDS signals the damage control system (DCS) to flood the selected space with a damage control agent (i.e., CO<sub>2</sub>).

**L. WATCHSTANDING CONCEPT**

The *Arsenal Ship* operates with a reduced manning concept. The crew is divided into operational watchstanders and a maintenance force. The maintenance personnel augment the normal watchstanders for all special evolution stations, and serve on damage control parties and security alert teams. Tables III-8 and III-9 show that 44 personnel are needed to man the *Arsenal Ship*. This manning reduction is accomplished by extensive use of automation, electronics and computer technologies, as well as enacting concepts that challenge current Navy customs and traditions. The crew must be highly experienced and versatile. Selected screening is required to ensure that only “top-flight” sailors are assigned to the *Arsenal Ship* program.

		Billet				Normal	Combat	Bridge		Helo	Boat	Damage
	Crew	Number	Title	Rank	Quals	Steaming	Steaming	Evolutions	UNREP	Operations	Operations	Control
												Physical
												Security
Command	1	Ops - 100	Captain	O-5/6	SWO							
	2	Eng - 100	Maintenance Officer	O-4	LDO							
Watch	3	Ops - 201	OOD	O-3	SWO	OOD #1	OOD #1	OOD #1	OOD #1	OOD #1	OOD #1	OOD #1
	4	Ops - 202	OOD	O-3	SWO	OOD #2	OOD #2	OOD #2	OOD #2	OOD #2	OOD #2	OOD #2
	5	Ops - 203	OOD	O-3	SWO	OOD #3	OOD #3	OOD #3	OOD #3	OOD #3	OOD #3	OOD #3
	6	Ops - 204	OOD	O-3	SWO	OOD #4	OOD #4	OOD #4	OOD #4	OOD #4	OOD #4	OOD #4
	7	Ops - 301	JOOD/lookout	E-7/8	QM	JOOD #1	JOOD #1	JOOD #1	JOOD #1	JOOD #1	JOOD #1	JOOD #1
	8	Ops - 302	JOOD/lookout	E-7/8	QM	JOOD #2	JOOD #2	JOOD #2	JOOD #2	JOOD #2	JOOD #2	JOOD #2
	9	Ops - 303	JOOD/lookout	E-7/8	QM	JOOD #3	JOOD #3	JOOD #3	JOOD #3	JOOD #3	JOOD #3	JOOD #3
	10	Ops - 304	JOOD/lookout	E-7/8	QM	JOOD #4	JOOD #4	JOOD #4	JOOD #4	JOOD #4	JOOD #4	JOOD #4
	11	Com - 201	CSO	O-4	SWO	CSO #1	CSO #1	CSO #1	CSO #1	CSO #1	CSO #1	CSO #1
	12	Com - 202	CSO	O-3	SWO	CSO #2	CSO #2	CSO #2	CSO #2	CSO #2	CSO #2	CSO #2
	13	Com - 301	COMMS	O-3	RM	COMMS #1	COMMS #1	COMMS #1	COMMS #1	COMMS #1	COMMS #1	COMMS #1
	14	Com - 302	COMMS	E-6	RM	COMMS #2	COMMS #2	COMMS #2	COMMS #2	COMMS #2	COMMS #2	COMMS #2
	15	Com - 401	SD	E-6	EW	SD #1	SD #1	SD #1	SD #1	SD #1	SD #1	SD #1
	16	Com - 402	SD	E-5	EW	SD #2	SD #2	SD #2	SD #2	SD #2	SD #2	SD #2
	17	Eng - 201	EOOW	E-7	EN	EOOW #1	EOOW #1	EOOW #1	EOOW #1	EOOW #1	EOOW #1	EOOW #1
	18	Eng - 202	EOOW	E-7	EN	EOOW #2	EOOW #2	EOOW #2	EOOW #2	EOOW #2	EOOW #2	EOOW #2
	19	Eng - 203	EOOW	E-7	EM	EOOW #3	EOOW #3	EOOW #3	EOOW #3	EOOW #3	EOOW #3	EOOW #3
	20	Eng - 204	EOOW	E-7	EM	EOOW #4	EOOW #4	EOOW #4	EOOW #4	EOOW #4	EOOW #4	EOOW #4
	21	Eng - 205	EO	E-6	EN	EO #1	EO #1	EO #1	EO #1	EO #1	EO #1	EO #1
	22	Eng - 206	EO	E-6	EN	EO #2	EO #2	EO #2	EO #2	EO #2	EO #2	EO #2
	23	Eng - 207	EO	E-5	EN	EO #3	EO #3	EO #3	EO #3	EO #3	EO #3	EO #3
	24	Eng - 208	EO	E-5	EM	EO #4	EO #4	EO #4	EO #4	EO #4	EO #4	EO #4

**Table III-8. Watch, Quarter and Station Bill for Watchstanders**



		Billet				Normal	Combat	Bridge		Helo	Boat	Damage
	Crew	Number	Title	Rank	Quals	Steaming	Steaming	Evolutions	UNREP	Operations	Operations	Control
												Physical
												Security
Admin	25	Adm - 501	Corpman	E-6	HM							
	26	Adm -502	Cook	E-6	MS							
	27	Adm -502	Cook	E-4	MS							
Labor	28	LF - 501	Deck Force	E-6	BM	Normal Work	Normal Work	Normal Work	Safety	LSE	Safety	SAT
Force	29	LF - 502	Deck Force	E-5	BM	Normal Work	Normal Work	Normal Work	Winch	Tiedown	Coxswain	SAT
	30	LF - 503	Deck Force	E-5	BM	Normal Work	Normal Work	Normal Work	Linehandler	Tiedown	Boat	SAT
	31	LF - 504	HME Force	E-6	DC	Normal Work	Normal Work	Normal Work	Fuel Sampler	OSL/AFFF		OSL/AFFF
	32	LF - 505	HME Force	E-6	EN	Normal Work	Normal Work	Normal Work	Linehandler	Team Leader	Engineman	Hoseman
	33	LF - 505	HME Force	E-5	EM	Normal Work	Normal Work	Normal Work	Linehandler	Hoseman	Linehandler	Hoseman
	34	LF - 506	HME Force	E-5	DC	Normal Work	Normal Work	Normal Work	Linehandler	Hoseman	Linehandler	Team Leader
	35	LF - 507	Combat Force	E-6	ET	Normal Work	Normal Work	Normal Work	Signals	Hotsuitman		Hoseman
	36	LF - 508	Combat Force	E-6	ET	Normal Work	Normal Work	Normal Work	Phonetalker	Hotsuitman		Plugman
	37	LF - 509	Combat Force	E-5	ET	Normal Work	Normal Work	Normal Work		Plugman		SAT
	38	LF - 510	Combat Force	E-5	ET	Normal Work	Normal Work	Normal Work				SAT
	39	LF - 510	Combat Force	E-6	GMM	Normal Work	Normal Work	Normal Work				SAT
	40	LF - 510	Combat Force	E-5	GMM	Normal Work	Normal Work	Normal Work				SAT
	41	LF - 510	Combat Force	E-4	GMM	Normal Work	Normal Work	Normal Work	Linehandler	Phonetalker		SAT
	42	LF - 510	Combat Force	E-4	GMM	Normal Work	Normal Work	Normal Work	Linehandler			SAT
	43	LF - 510	Combat Force	E-4	GMM	Normal Work	Normal Work	Normal Work				SAT
	44	LF - 510	Combat Force	E-4	GMM	Normal Work	Normal Work	Normal Work				SAT

**Table III-9. Watch, Quarter and Station Bill for Special Evolutions**

## **IV. COMBAT SYSTEMS**

This chapter provides an detailed description of the *Arsenal Ship* combat system. First, a brief overview of the entire combat system is provided followed by sections covering the launcher system, Anti-Air Warfare, Strike Warfare, Theater Ballistic Missile Defense, ship self defense, Naval Surface Fire Support, Command and Control, Communications, topside design, and underway missile replenishment.

### **A. COMBAT SYSTEMS DESIGN OVERVIEW**

The selection of combat systems for the *Arsenal Ship* is driven by the single requirement that it must complete the assigned missions within the constraints of minimum acquisition and life cycle cost [4,5]. The *Arsenal Ship*'s combat system is one of low maintenance and high reliability. The total ship inherent availability goal is 0.95 and the operational availability is 0.85. The weapon control subsystem reliability goal is 0.99. Therefore, combat system material selection, equipment, arrangement, built-in-test equipment, redundancy, and equipment reliability is heavily dependent on currently available and proven technologies.

The *Arsenal Ship* deploys under the escort of an Aegis warship equipped with the Cooperative Engagement Capability (CEC). The Aegis escort ship provides Command and Control over the weapons onboard the *Arsenal Ship*. The *Arsenal Ship* contains minimum equipment required to support remote launching of its weapons. The capability exists for control to be extended to platforms other than the Aegis escort, such as an Airborne Warning and Control System (AWACS) platform or even a CONUS station through satellite communication (SATCOM) links, but the concept of operations requires

an *Aegis Control Ship* for protection as well as connectivity. The *Arsenal Ship* is effectively a remote magazine for the *Aegis* escort and does not have an autonomous engagement capability.

The *Arsenal Ship* has connectivity with Army, Air Force, and Marine Corps personnel, for launch of strike weapons and Naval Surface Fire Support (NSFS), through the *Control Ship*. The combat systems onboard the *Arsenal Ship* are kept to a minimum to reduce cost, manning, maintenance, training, and logistics. Tactical Aircraft Control and Navigation (TACAN) and search radars are not included in order to reduce the required avionics support personnel, combat information architecture, and manning. The *Control Ship* has responsibility for planning and reporting any weapon firing...All post launch missile communications are performed by the *Control Ship*.

CEC provides the primary link between the *Aegis* escort ship and the *Arsenal Ship* for digital targeting information and weapon data. UHF Link 16 is the secondary link and HF link 22 (improved link 11) is the tertiary backup for providing digital data. This is shown in Figure IV-1. SATCOM connectivity includes the future Global Broadcast System (GBS). This permits CONUS based planning for weapon systems. Support equipment is networked through a dual ring LAN that provides data from CEC/Link-16/link-11 to the Advanced Tactical Weapon Control System commonly referred to as big "T" ATWCS (A"TWCS). A"TWCS is currently being designed to communicate with SM-2, TLAM, and ATACMS.

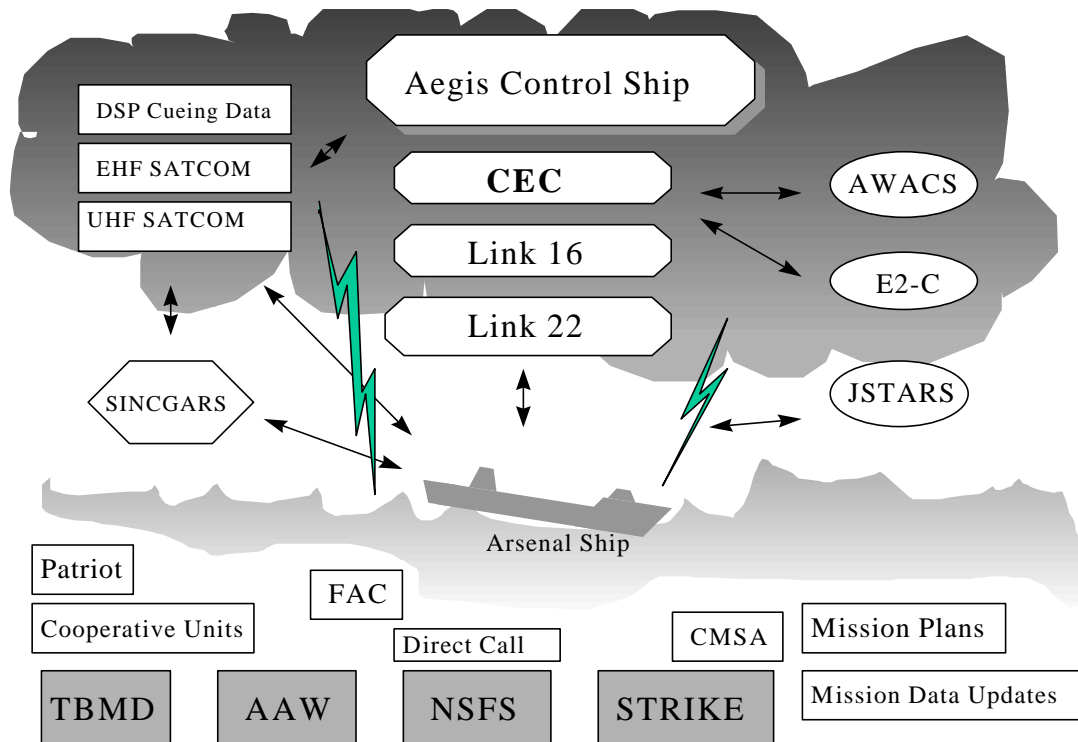

**Figure IV-1: Communications For The Arsenal Ship**

Required missions for the *Arsenal Ship* are Anti-Air Warfare (AAW), Strike Warfare, Theater Ballistic Missile Defense (TBMD), ship self defense, and NSFS. The *Arsenal Ship* employs Standard Missile (SM-2), Tomahawk Land Attack Missile (TLAM), Army Advanced Tactical Missile (naval version ATACMS), and SM-2 Lightweight Exoatmospheric Projectile (LEAP), all launched from the Mk 41 Vertical Launcher System (VLS). The Rolling Airframe Missile (RAM), Advanced Integrated Electronic Warfare System (AIEWS) and various decoys provide ship self defense. The future Vertical Gun for Advanced Ships (VGAS) is a preplanned improvement to the *Arsenal Ship* for increased NSFS capability. This is conceptualized in Figure IV-2.

# The Arsenal Ship Combat System

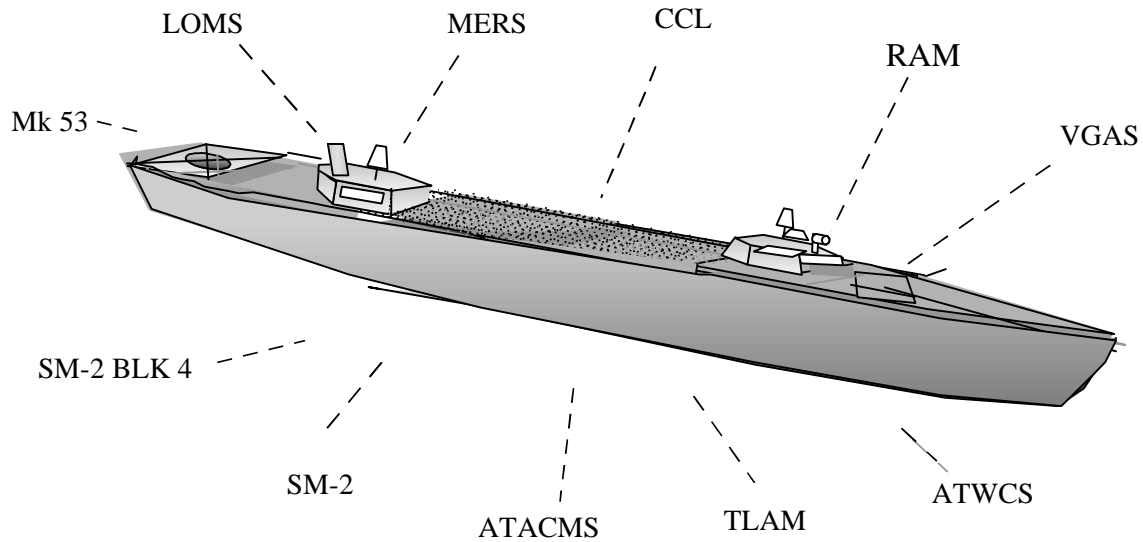

**Figure IV-2: Arsenal Ship Combat System Summary**

## **B. LAUNCHER SYSTEMS**

The MK-41 VLS and Concentric Canister (CCL) launcher systems were considered for the *Arsenal Ship* design. A description of the operation, advantages and disadvantages of each system is provided along with a justification for final launcher selection.[23,24]

### **1. MK-41 Vertical Launch System**

The MK-41 has tremendous reliability and support and is capable of launching all the desired weapons. The MK-41 is presently carried on 22 ships of the Ticonderoga Class (CG 52), 24 ships of the Spruance Class (DD 963), and 24 ships of the Arleigh

Burke Class (DDG 51). It is also in use by our allies on the Tribal Class, Brandenburg Class, Kongo Class, and Mursame Class. The MK-41 program has delivered over 900 Modules over the past 12 years with almost 7000 cells presently in use.

The MK-41 VLS is fully supported by the existing military and industrial infrastructure from acquisition, installation, in-service engineering, and complete life-cycle support. The use of the MK-41 VLS for the *Arsenal Ship* has minimal impact on existing shore support facilities, training support, and shore manning requirements. It meets the requirements for prevention of Hazards of Electromagnetic Radiation to Personnel (HERP) and Ordnance (HERO).

The MK-41 is capable of launching the Tomahawk Anti-ship and Land Attack Missile, Standard Missile-2, Standard Missile-2 Block 4, Seasparrow and Evolved Seasparrow Missile (ESSM), and the Vertical Launch Anti-submarine Rocket (VLA). It has the flexibility to be adapted for ATACMS as a NSFS launch platform. It integrates existing technology and is available for a FY00 installation.

## **2. Concentric Canister Launcher**

The Concentric Canister Launcher (CCL) is an alternative to the MK-41 VLS. CCL has several distinct advantages over the MK-41 VLS. There are significant considerations for ship survivability, hull mechanical and electrical (HM&E) to weapons systems integration, safety, producibility, affordability, and combat system integration. The CCL is depicted in Figure IV-3.

# “Concentric Canisterized” Launcher

- Concentric Tubes Launcher
- Anti-fragmentation Shields
- Concentric Plenum
- COTS/Open Electronics
- Under development

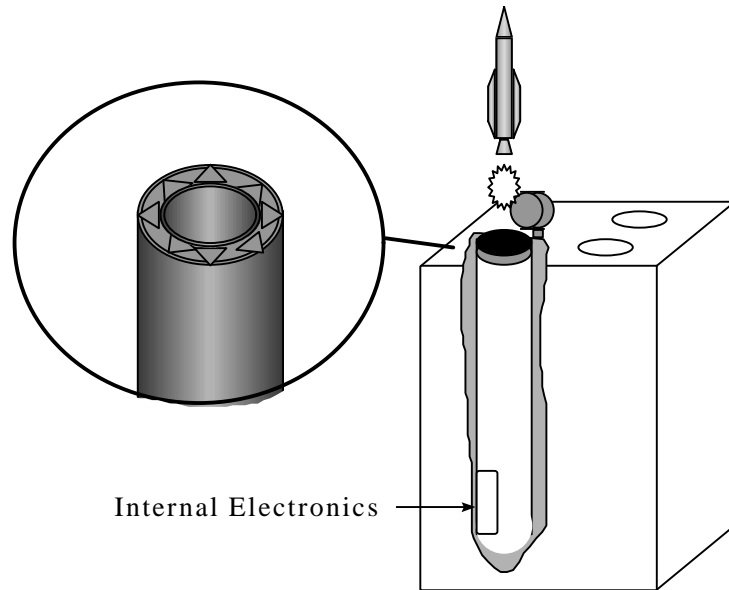

**Figure IV-3: CCL Summarized**

The MK-41 vertical launcher uses a shared-exhaust gas management system, encapsulated missiles, and shares a magazine. The MK-41 is a low risk, but expensive option for the *Arsenal Ship* launcher. The CCL is a second option for the *Arsenal Ship*. The CCL concept employs a concentric launcher that can be used for diverse munitions types and sizes. It is an All-Up-Round (AUR) that is stowed ready to fire and provides passive armor and a self contained Gas Management system.

The CCL is a self-contained launcher mechanically and electrically. The electronic assembly can be packaged within a protected annular space. It can include anti-fragmentation shields between concentric tubes to provide increased protection between launchers than is available in the MK 41.

Shock effects cause an impulsive motion of the ship up and away from the charge. Accelerations typically measured in a ship are much greater below the surface for an underwater blast than are experienced topside. CCL incorporates a shock collar that mitigates the larger G- forces experienced on lower decks. Care needs to be taken during ship design to ensure sufficient GMT due to the pendulum type effects of mounting weight at a high attach point.

### **3. Launcher Selection**

The CCL open architecture provides the framework to cost-effectively capture existing and future technology. The costs of the CCL are projected to be less than the MK 41 with the increased benefits of simplicity, increased survivability, and an open-electronic architecture. Should the CCL evolve as anticipated by NSWC, and prove reliable, it would make a better choice for the launcher of the *Arsenal Ship* than the MK 41. But the CCL concept is far from existing technology and we have chosen to design the ship around the MK 41, due to the practical nature of the Total Ship System Engineering approach.

### **C. AAW, STRIKE WARFARE AND TMBD**

The *Arsenal Ship* acts as a force multiplier for the AAW, Strike Warfare and TMBD mission by increasing the number of weapons available in theater for these warfare areas. The ability of the *Arsenal Ship*'s missiles to be remotely launched by the *Control Ship* is the cornerstone of this design. The specific functional breakdown used to obtain this capability is government sensitive information. Therefore, the details of the interrelationships between the *Arsenal Ship* and the *Control Ship* for SM-2 and TLAM



engagements are given in Appendix A, which is a government only distribution document. For completeness, it should be noted, that the remote launch capability is achievable with the designed combat system.

#### **D. SHIP SELF DEFENSE**

Determination of the required *Arsenal Ship* self defense capability begins with an investigation of the possible threats, which the ship will encounter. System selection is based on expected threats and operating conditions, while maintaining a balance between active and passive defense capabilities.

##### **1. Threat Analysis**

The *Arsenal Ship* by the nature of its concept of operations will be presented with a variety of threat postures worldwide. While the nature of threat remains multi-dimensional, the specific threats will vary over time and location. Our design incorporates a qualitative look at the threat, rather than a quantitative look, as a guideline for a survivable platform. This assessment is summarized in Figure IV.4.

**Air Threat:** Air Launched Anti-Ship Missiles, Bombs, Guns

Design Response:

Passive

Susceptibility

**Signature Levels**

-RCS (reduce)

-IR (reduce)

Vulnerability

**Damage Tolerance**

-Size

-Separation

-Redundancy

-Selective Armor

**Damage Control**

-automatic response

Active

**Self Defense**

-RAM (hard kill)

-ECM/Decoys (soft kill)

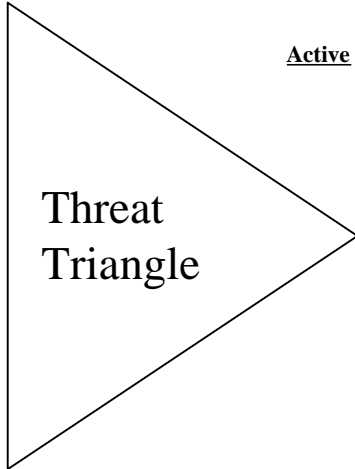

**Surface Threat:** Anti-Ship Missiles, Guns

Design Response:

Passive

Susceptibility

**Signature Levels**

-RCS (reduce)

-IR (reduce)

Vulnerability

**Damage Tolerance**

-Size

-Separation

-Redundancy

-Selective Armor

**Damage Control**

-automatic response

Active

**Self Defense**

-RAM (hard kill)

-ECM/Decoys (soft kill)

**Underwater Threat:** Mines, Torpedos

Design Response:

Passive

Susceptibility

**Signature Levels**

-Acoustic Reduction

shock mount

HVME

-Magnetic Reduction

Degaussing

Active

**Self Defense**

-Decoys (softkill)

Vulnerability

**Damage Tolerance**

-Size

-Separation

-Redundancy

-Selective Armor

**Damage Control**

-automatic response

**Figure IV-4. Arsenal Ship Threat Triangle**

In our assessment of the threat to the *Arsenal Ship*, we determined that a majority of the defense for the vessel will be offboard. The ship itself has little active defense and relies on passive capability. However, it must be kept in mind how the ship works as part of a larger system when considering threat and defense. The *Arsenal Ship* does not operate alone. As a remote magazine with an *Aegis Control Ship*, it has the protection of the *Control Ship* systems. As a battlegroup member, the *Arsenal Ship* has a further umbrella of protection. Thinking of the *Arsenal Ship* as a subsystem of a larger system, it is not defenseless.

## **2. Detection Elements**

### **a. AAW/ASCM Threat**

Except for a short-range navigation radar, the *Arsenal Ship* possesses no active surface- or air-search radar. Therefore, the primary detection of AAW/ASCM threats rests upon surface escorts.

### **b. Electronic Warfare**

The *Arsenal Ship* uses the new Advanced Integrated Electronic Warfare System (AIEWS) Phase II as its Electronic Support Measures (ESM) detection system. The initiation of Phase I of this system into the fleet is scheduled for FY00, with Phase II to follow soon thereafter. This system possesses passive radio frequency (RF) detection and identification capabilities, and active jamming capabilities. Since this program is still in the design stages, the existing hardware of SLQ-32 (V)3 is used as a model for design purposes. AIEWS is made up of the following elements:

- Port and Starboard Antenna/Receiver Units
- Signal Processing Units
- Display and Control Console

### **c. ASW Threat**

Based on the manning and fiscal constraints, the *Arsenal Ship* depends on surface and submarine escorts to provide underwater threat detection and protection.

### **3. Control**

#### **a. Ship Self-Defense System (SSDS)**

The SSDS is an integration and control system for the *Arsenal Ship*'s self-defense suite. It provides a quick reaction combat capability to the *Arsenal Ship*. The SSDS receives target-data inputs from CEC, and ESM information from AIEWS. The capabilities of the SSDS are summarized as follows:

- Correlates CEC tracks and ESM detections for tracks which meet the proper criteria, passes necessary missile-initiation information to RAM MK 31 Block 0/1, and receives and displays decoy recommendations provided by AIEWS.
- Integrates the use of hardkill and softkill defenses.
- Designates whether systems operate in an automatic or semi-automatic mode.
- Automatic mode allows for the defense systems to be fired with no operator intervention.
- Semi-automatic mode recommends the system to be used for the engagement and a time to fire, but the operator is required to physically fire the weapon or decoy [25].

#### **b. AIEWS**

The AIEWS supports the various types of softkill decoys launched from the *Arsenal Ship*. It gives decoy selection, tube selection, re-seed time calculations, and reload recommendations [26].

## **ARSENAL SHIP SELF DEFENSE SUITE**

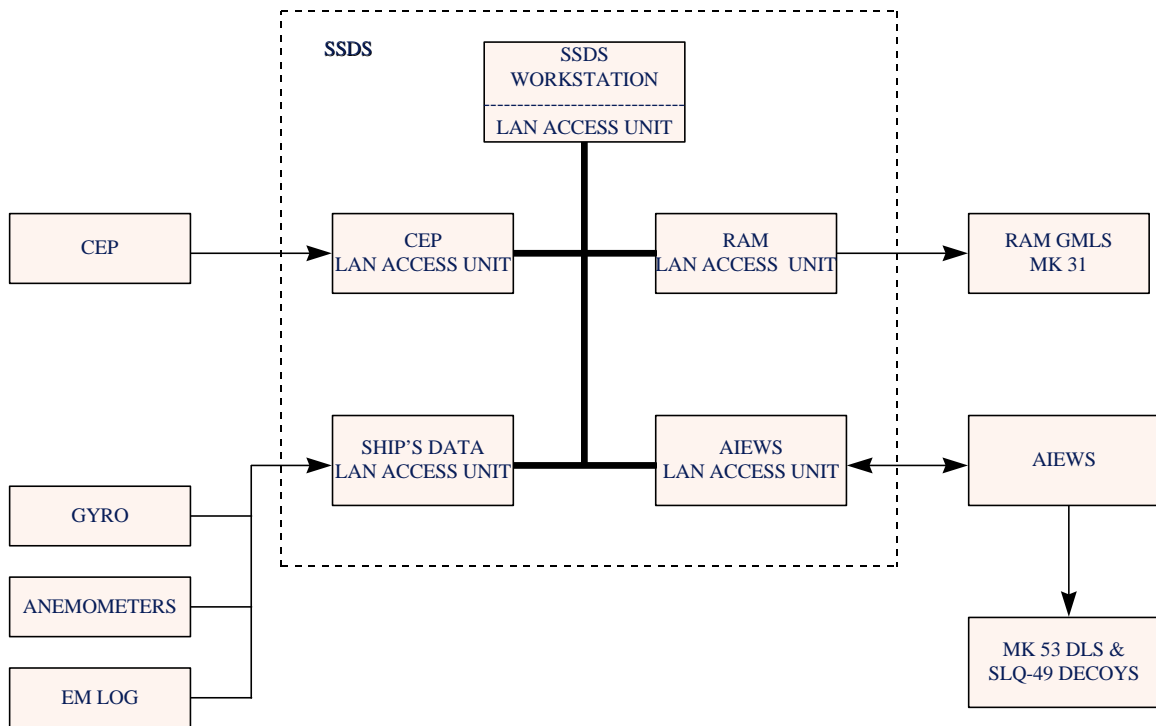

**Figure IV-5: Arsenal Ship Self-Defense Suite**

### **4. Engagement**

#### **a. Missiles**

The *Arsenal Ship* uses the RAM MK 31 Block 0/1 Guided Missile Weapon System (GMWS) for its hardkill self defense. The RAM MK 31 GMWS consists of the following elements:

- Weapon Control Panel (WCP)
- Launcher Control Interface Unit (LICU)
- Launcher Servo Control Unit (LSCU)
- (1) MK 144 Launcher (missile capacity 21)

The block 0 RAM system uses RF midcourse and infrared (IR) terminal phase guidance. The block 0 RAM system receives 2-D range and bearing information from CEC, and correlates bearing and RF Band (I or J) information from AIEWS. The block 1 RAM system uses IR for both its midcourse and terminal phase guidance. The Block 1 RAM system must receive 3-D inputs of range, bearing, and elevation from CEC. All inputs are passed to the RAM system via SSDS for missile initiation. A distinct advantage of the RAM missile is that it's a fire-and-forget, lock-on after launch, missile [27].

**b. Decoys**

The *Arsenal Ship* possesses an assortment of softkill decoys to defeat a possible variety of threats. It employs chaff, IR, NULKA and SLQ-49 (rubber duck) decoys. The chaff decoys are launched into the air, and explode to create a chaff cloud of aluminum strips. The IR decoys are launched and float on the water surface producing a large thermal signature. The NULKA decoy is launched into the air, and follows a controlled flight path. While in flight, the NULKA decoy receives, amplifies, and re-radiates signals as specified by the EW operator. The chaff, IR, and NULKA decoys are supported by the MK 53 Decoy Launching System (DLS). The MK 53 DLS consists of the following elements:

- MK 24 Decoy Launch Processor (DLP)
- MK 174 Processor Power Supply (PPS)
- (2) MK 137 Mod 7 Launchers
- (2) Ready Service Lockers (RSL)
- (2) MK 164 Mod 2 Bridge Launcher Control (BLC)

(1) Combat Launcher Control (CLC) [28]

The Rubber Duck decoy consists of two tethered un-inflated radar retro-reflectors which are stored in a lifeboat-like canister, ready to deploy over-the-side, launcher. Once launched and inflated, the pair of retro-reflectors produce a large ship-like radar return. This type of return is broadband in nature, and does not limit the recognition of narrow-band RF energy used by the incoming weapon [29]. Therefore, this type of decoy is useful in combating RF weapons operating in a frequency band outside the active ESM frequency band, and outside NULKA's capabilities. Rubber Ducks are remotely launched from the Combat Information Center (CIC), or manually at the launcher.

#### **E. NAVAL SURFACE FIRE SUPPORT**

As the Navy's threat focus shifted from blue water to the littorals, the Naval Service has shifted its operational focus as highlighted in "*From the Sea...*" and "*Forward, From the Sea...*". *Operational Maneuver from the Sea* has become the predominant concept for the projection of naval power ashore, of which Naval Surface Fire Support is a major component.

The *Arsenal Ship* Concept of Operations (CONOPS) establishes the requirement for the *Arsenal Ship* to provide NSFS to Joint Ground Forces. CONOPS describes representative Surface Fire Support target sets to be countered by *Arsenal Ship* and recommends the Surface Fire Support weapon capabilities desired. This is summarized in Tables IV-1 and IV-2. [4].

	<b>Halt Invasion</b>	<b>Long Range Strike</b>	<b>Battlespace Dominance</b>	<b>Surface Fire Support</b>
Complex Adaptive Armed Forces	Air Land Maneuver Battle Groups (e.g., OMGs)	National / Regional C4I Space Control	Manned A/C TBMs, UAVs Cruise Missiles. SAM/AAA	Long-Range Artillery TBMs Logistics Assets
Armored Mech Armed Forces	Armor-Heavy Comb. Arms Formations Divisions/BDEs	National and Regional C4I	Manned A/C TBMs SAM/AAA	Long-Range Artillery
Infantry Based Armed Forces	Armor/Mech "Pure" units (BDEs/BNs)	Military Region District C4I	Manned A/C SAM/AAA	Medium-Range Artillery Logistics Assets
Internal Security Light Force	Transportation Railroads Trucking, Light Vehicles	National CMD Authority Military Concentrations	OP Bases Light A/C Coastal Patrol Craft	Logistics Assets Economic Asset Local Forces

**Table IV-1. Arsenal Ship Representative NSFS Targets.**

	<b>Halt Invasion</b>	<b>Long Range Strike</b>	<b>Battlespace Dominance</b>	<b>Surface Fire Support</b>
Complex Adaptive Armed Forces	ATACMS-BAT SLAM TLAM-TSTAR TLAM-C	TLAM	ATACMS TLAM-C/D SM-2 Blk III A/B and Blk IVA	ATACMS, SLAM, STRIKE-SM TLAM-C/D NAVAL GUNFIRE (VGAS/SCRAM)
Armored Mechanized Armed Forces	ATACMS-BAT TLAM-TSTAR SLAM STRIKE-SM	ATACMS-BAT TLAM-TSTAR SLAM STRIKE-SM	ATACMS TLAM-C/D SM-2 Blk III A/B and Blk IVA	ATACMS, SLAM, STRIKE-SM TLAM-C/D NAVAL GUNFIRE (VGAS/SCRAM)
Infantry Based Armed Forces	ATACMS SLAM STRIKE-SM	TLAM-D ATACMS-ER	ATACMS	ATACMS, SLAM, STRIKE-SM TLAM-C/D NAVAL GUNFIRE (VGAS/SCRAM)
Internal Security Light Force	NAVAL GUNFIRE (VGAS/SCRAM)	TLAM-C	ATACMS NAVAL GUNFIRE (VGAS/SCRAM)	ATACMS NAVAL GUNFIRE (VGAS/SCRAM)

**Table IV-2. Suggested Arsenal Ship NSFS Weapon Capabilities.**

CONOPS addresses NSFS by requiring the *Arsenal Ship* to carry 500 missiles and have space, weight and support system capacity for future installation of an extended range gun system. The Navy currently has a number of programs, projects and Advanced Technology Demonstrators (ATD) that provide solutions to the NSFS problem. The



NSFS systems is broadly separated into Guns/Projectiles and Missiles. Connectivity for targeting and command and control is similar across the spectrum of NSFS.

## **1. Guns/Projectiles**

The Navy is currently pursuing a 5-inch gun modification and the VGAS, along with numerous projectile options for NSFS. VGAS. VGAS is the future gun system for the *Arsenal Ship*.

As a current Advanced Technology Demonstrator within the NSFS Program, VGAS embodies the Navy's plan to use a 155-mm gun for fire support and deep strike applications. This answers the NSFS Cost and Operational Effectiveness Analysis (COEA) in which the need for larger payloads and extended range is identified. [30] The larger gun has a longer range than the 5-inch, covering missions beyond 150 nautical miles. This range is only reachable by ATACMS, within the NSFS 10 minute response limit.

VGAS employs a completely automated gun system packaged in a Ship System Engineering Standard (SSES) B-module which is set flush with the ships' deck [31] (Figure IV-5).

Two 155mm guns per module use an automated loader with multi-ram modular advanced projectiles. An automated system of propelling charge buildup accommodates a wide range of projectile weights. The program piggy-backs off of Navy/Army/Marine Corps technological base to provide a high payoff . The payoff in technology is electro-thermal ignition of high energy propelling charges, high packing density of 700 rounds

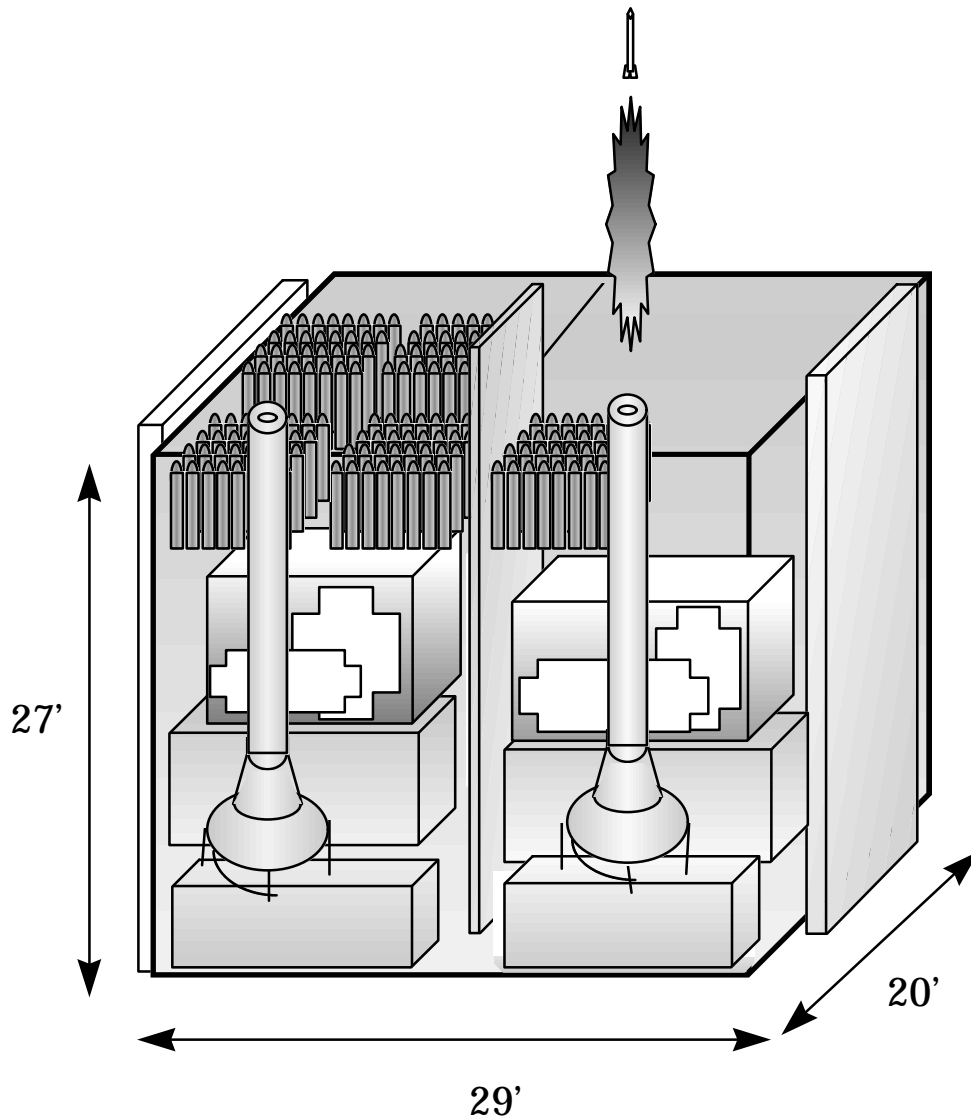

**Figure IV-6. The Vertical Gun for Advanced Ships (VGAS)**

per gun, 15 rounds per minute per gun, and a gun which can support not only NSFS, but also deep strike applications. The advantages and disadvantages of the 155-mm VGAS are briefly summarized in Table IV-3. [32] The physics of guns and projectiles is well understood and the risk defined within the initial development of a new system is minimal.

<b>Vertical Gun for Advanced Ships</b>	
<b>Advantages</b>	<b>Disadvantages</b>
•SSES-B Module Design	•Development Risk
•Reduced Manning (0 to operate, 1-3 to maintain)	•Advanced metallurgy for key gun components
•Reduced Topside RCS (Low, Protected Location)	•High rate-of-fire with the rotating chamber
•Extended Performance (300 lbm warhead to 275 NMI)	•Thermal management
•Commonality of Munitions with Army/Marine Corps	•Multiple ram operations for guided munitions
•No Train or Elevation Mechanisms	•Overpressure requires elevated firing

**Table IV-3. Vertical Gun for Advanced Ships Advantages and Disadvantages**

The near term solution (IOC 2001) is 5-inch MK 45 gun mount modifications to allow the firing of the Extended Range Guided Munitions (ERGM). This is a major rework of the current gun system requiring a new 60-70 cal barrel, breech and breech operating mechanism, empty case tray, and modified slide, gun barrel housing, recoil, counter-recoil system, data communication interface, stand, carriage and upper hydraulics. These changes increase the gun energy from 10 Megajoules to 18 Megajoules, and nearly doubles the ballistic range. This also allows for a sustained rate of fire of the ERGM (double ram) of 10 rounds per minute and maintains an AAW/ASUW and Shore Fire Ballistic Round Capability of 20 rounds per minute [33].

To achieve the required NSFS ranges, the gun fires the Extended Range Guided Munitions (ERGM-EX 171). The ERGM is a rocket-assisted projectile equipped with a submunition warhead and Global Positioning System (GPS) and Inertial Navigation

System (INS) coupled- guidance. A pre-planned product improvement of the ERGM calls for a terminal homing-seeker and unitary payload to extend coverage to point targets [34]. The advantages and disadvantages of the 5-inch gun using the ERGM are listed in Table IV-4.

<b>5-inch MK 45 Gun Mount Modifications with ERGM</b>	
<b>Advantages</b>	<b>Disadvantages</b>
•Current Program Status	•Near Term Fix-Just Meets NSFS Requirements
•IOC 2001	•No Reduction in Manning to Operate (Requires 10+)
•Range of 63 NMI with ERGM	•Inherent Above Deck RCS
	•Requires Train and Elevation (Gun Fire Control System)
	•Requires Major Rework of Gun System

**Table IV-4. Advantages and Disadvantages of the 5-inch Gun modifications with ERGM**

The 5-inch gun with ERGM make it a viable candidate for the future gun system. The disadvantages, however, are significant and the VGAS program is concurrently researched.

## **2. NSFS Missiles**

The Tomahawk missile is used for non-time critical NSFS. Despite high per-missile replacement costs, the TLAM has already covered development costs and continue to decrease in per-unit cost. The ATACMS) is under investigation as a joint

candidate for a fire support missile. The viability of ATACMS rests on industry funded MK 41 VLS integration and test firing in December 1996. The challenge of ATACMS is to fit a 24-inch diameter missile, with folded fins and modified-umbilical connections, in a 25-inch VLS cell.

A modified-Harpoon variant named the Sea SLAM, and a Standard Missile Strike variant have been investigated as fire support missile options [35]. These missiles are not selected for the *Arsenal Ship* due to lack of current and projected program funding [36].

### **3. NSFS Weapon Control**

NSFS weapon control on the *Arsenal Ship* is performed by the Advanced Tactical Weapon Control System (A"TWCS). This system provides an open architecture, flexible-control interface to NSFS precision munitions. It is currently configured for TLAM and is being configured through software modules for VGAS, ERGM and ATACMS. Additional modules are added for follow-on NSFS munitions (i.e., Strike-SM, SLAM, etc.) [37].

### **4. Discussion**

NSFS Cost and Operational Effectiveness Analysis (COEA) completed in December 1994, addresses the need for naval surface forces to provide credible NSFS for expeditionary forces [30]. This support is required at a minimum 43 nautical miles, with a goal of 63 nautical miles, within 10 minutes. This range is based on the firing platform stationed 25 nautical miles offshore. Ranges in excess of 63 nautical miles provide additional flexibility and extended lethality. The NSFS COEA is a complete assessment which considers 30 guns, 100 projectiles and 7 missiles. The Center for Navy Analysis

(CNA) along with weapon system development program offices at NAVSEA and warfare centers at Dahlgren, Louisville, and China Lake have estimated the cost for candidate weapon systems. The lethality estimated for each candidate weapon system, is based on number of rounds required to strike each target as a function of range, target location error and desired effect. Headquarters Marine Corps (HQMC) and the Marine Corps Combat Development Command (MCCDC) selected three different representative scenarios, developed operational concepts and produced time-phased target lists for each scenario consistent with the Defense Planning Guide to establish baseline effectiveness comparisons. Operational effectiveness is established as the cost to achieve a given effectiveness for each candidate weapon system and combination of systems. System integration considerations determine the feasibility of integrating the most promising system(s) onto a ship. The COEA also addresses follow-on efforts, highlighting longer range possibilities and NSFS as a complement to TACAIR.

The COEA team identified the most cost-effective solution as a combination of 155-mm guns and Tomahawk missiles. The major driving factors for NSFS weapon options were the requirement that the system concept be technically feasible, achieve IOC within 10 years (of 1994) and be considered effective.

The combination of guns and missiles provides a cost-effective balance of systems for NSFS. In terms of cost-effectiveness not one of the missile concepts considered could compete with guns as a low-cost delivery platform of munitions. The one gun concept considered could fire a sufficiently large unitary charge far enough inland, with sufficient anti-jam capability, to take care of certain elements of a target set. However, a combination of guns and missiles, with guns taking out the majority of the required

targets, is modeled to defeat scenario target-sets at minimum total life-cycle cost. Guns and missiles are usually complementary in range, warhead size and cost. Guns usually have a shorter range, smaller warhead and smaller replacement cost. Advanced gun concepts with increased ranges allow projectiles to engage targets previously reachable only with a missile option.

The NSFS COEA options are listed in Table IV-5 in order of increasing cost.

<b>NSFS Cost Effective Options</b>
(1) New 155mm/60 cal gun with advanced propellant and a family of rocket assisted precision guided munitions AND TLAM
(2) The above gun with TLAM plus ATACMS (deck-launched derivative)
(3) The above gun with TLAM plus ballistic missile sized to fit short VLS cell (i.e. SMASHR, Standard Missile Autonomous Strike Homing Round)
(4) The above gun with TLAM plus boost/glide missile sized to fit short VLS cell (i.e. JSOW, Joint Stand Off Weapon derivative)

**Table IV-5. NSFS Cost Effective Options.**

The Operational Analysis (OA) criteria examines which rounds can attack each given target for the smallest replacement cost. Various warhead selections are required for both gun and missiles to defeat a target set. This is summarized in Table IV-6.

•Unitary HEU (conventional high explosive unguided without terminal seeker)
•Unitary HEG (conventional high explosive guided with or without terminal seeker)
TARGET SETS: radar complex, vans, troops in open, truck convoy, buildings
•DPICM (Dual Purpose Improved Conventional Munitions i.e. submunitions)
TARGET SETS: distributed targets (dispersed troops/foxholes)
•Penetrating/Shaped Charge
TARGET SETS: command bunkers, pill boxes, hardened sites, tanks, armored vehicles
•ATGSM (Autonomous Terminally Guided Submunitions)
•BAT (Brilliant Anti-Tank)
•SADARM (Sense And Destroy Armor)
TARGET SETS: same type targets, tanks and armored vehicles

**Table IV-6. Gun and Missile Warhead Selections.**

These warheads provide extended range as RAP (Rocket Assisted Projectiles) and provide the necessary precision through GPS and INS, with or without terminal seekers. GPS and INS are adequate for most HE unitary and DPICM rounds. Penetrating and shaped-charge rounds usually require better accuracy than is achievable with GPS alone.



## **F. COMMAND AND CONTROL SYSTEMS**

### **1. Command and Control Goals**

The *Arsenal Ship* must have complete connectivity with the *Control Ship* and other Commanders who may need to use the weapons within its magazine. It must have interoperability with Joint and Service C4 systems. It has commonality with existing systems that do not require further development costs that the *Arsenal Ship* would have to be responsible for. Non-developmental items and existing commercial off the shelf (COTS) technologies keep costs down and bring the most advanced electronics equipment in the shortest time to the *Arsenal Ship* Program.

The C4 Architecture onboard the *Arsenal Ship* is redundant and provides reliable, back-up paths for information to flow despite battle damage or malfunctioning equipment. It is adapted from existing equipment and technologies and further automated with Smart Ship efforts to reduce manning and maintenance. A fiber optic network and distributed/redundant equipment provides rapid information distribution subsystems for the “Combat Commander.”

The communications equipment onboard the *Arsenal Ship* takes advantage of a range of frequency regions in order to guarantee data transmission under various meteorological, oceanographic, and operational conditions. It is imperative that the *Arsenal Ship* have survivable, protected, and sustainable command, control, communications, computer, and Intelligence systems.

## 2. C<sup>4</sup> Employment

Different conflict levels will impose different, and perhaps contentious, requirements on the C4 systems that support the *Arsenal Ship*. Peacetime C4 systems support daily operations, attack warning, and transition to warfare. During a crisis, the *Arsenal Ship* will provide an opportunity for conventional deterrence. Critical C2 connectivity is needed between the military units and their combatant commander. In a conventional war, the combatant commander may take control of C4 forces that are not organic to tactical forces. System control provides network status and supports reconfiguration and reconstitution. As a crisis expands, additional nodes may be brought on line.

The Joint Maritime Communications Strategy (JMCS) is the communications architecture the Navy will use to implement *Copernicus...Forward*, the C4I vision for the future. It is technical as well as a strategy using nondevelopmental item communication systems. JMCS consists of three technical elements the *Arsenal Ship* will employ: the Automated Digital Network System (ADNS), the Digital Network System (DMR System), and the Integrated Terminal Program (ITP). ADS will increase the efficiency of information transfer by pooling communication resources. DMR uses modular radio components for HF, VHF, and UHF communications and covers the spectrum of tactical comm. It will field the integrated, multiband antenna known as the Multifunction Electromagnetic Radiating System which will reduce topside space and weight and reduce the *Arsenal Ship* cross section. ITP will provide SHF, EHF, and commercial SATCOM band terminals. It will leverage commercial terminal systems and services such as Direct Broadcast Satellite Service and Global Broadcast Service. ITP will also

develop and implement multifunction antennas such as the Low Observable Multifunction Stack, that integrates SATCOM antennas into a single lightweight structure. This will significantly reduce the Arsenal Ship radar cross section and IR signature. (ref. E1, p 18-19)

Command can take three very different forms in peacetime operations: Combatant Command (COCOM), Operational Control (OPCON), or Tactical Control. Combatant Command means owning the forces. The commander has the full range of authority and responsibility inherent in the concept of military command. Operational Control allows for maximum control without full command or the burden of support. [38]

Presidential Decision Directive 25 notes that “Operational control is a subset of command. It is given for a specific time frame or mission and includes the authority to assign tasks to US forces already deployed by the President and assign tasks to US units led by US officers.” Tactical control is defined by JCS Pub 1 as “the detailed and, usually local direction and control of movements or maneuvers necessary to assign missions and assigned tasks.” [39]

Major US military operations are going to be joint for a long time! They will include forces from more than one Service and will participate under a single commander. The National Command Authority (NCA) consists of the President and his advisors provides the overall guidance. One CINC, usually a theater commander such as CINCPAC or CINCCENT, provides the operational guidance in close cooperation with the commander of the Combined Joint Task Force (CJTF). The CJTF is usually made of up force components that are functionally differentiated. [40]

The *Arsenal Ship* will function within the existing command and control infrastructure. It will not be staffed such that it can assume Composite Warfare Commander responsibilities, but will be an integral ship whose weapons are under the control of the Composite Warfare Commanders who will report to the CJTF. Existing C4 equipment and procedures will be adapted to include the *Arsenal Ship*.

### **3. Naval Telecommunications Automation Programs**

Major initiatives have been undertaken since the 1960s to automate shipboard communications. The Naval Tactical Data System (NTDS), Naval Modular Automated Communication System (NAVMACS), Naval Telecommunications System (NTS) Architecture, Integrated Communications System/Shipboard Communications Area Net (ICS/SCAN), Survivable Adaptable Fiber Embedded Network (SAFENET), Unified Networking Technology (UNT), Communication Support System (CCS) and Copernicus Architecture have all been developed as major steps in the modernization of shipboard suites. [41]

The *Arsenal Ship* takes advances in technology to provide a survivable, integrated, redundant, effective, and automated system. The overall goals of reduced manning and cost through application of existing technologies still apply!

## **G. COMMUNICATIONS**

This section explores the exterior and interior communication requirements for the *Arsenal Ship*. The shipboard systems required are identified and the interrelationships between the systems is explained.

## 1. 1. External Communications Equipment

The *Arsenal Ship* Concept of Operations requires the ship to be capable of full-time communications with ships, aircraft, satellites and shore stations via responsive, reliable, clear and secure voice, tactical information distribution, and recorded communications. A survey of current primary communications equipment was conducted to set a baseline for the *Arsenal Ship*. Current Advanced Technology Demonstrators (ATDs ) were reviewed to see what concepts will be available close to, or soon after the *Arsenal Ship* is built to ensure infrastructure is in place to facilitate integration.

ATDs and concepts with applicability to the *Arsenal Ship* include the Low Observable Multi-Function Stack, Multi-Function Electromagnetic Radiation System (MERS), Advanced Enclosed Mast Sensor System (AEM/S), and the Integrated HF Broadband Antenna, Figure IV-7, [42]. The *Arsenal Ship* superstructure was designed not only with reduced radar cross-section in mind using a ten degree slope, but also with the intention of integrating these advanced concepts as they become available. Our design incorporates current available equipment as the baseline communications suite with the capability and intent to upgrade.

## Supports Integrated Topside Concepts

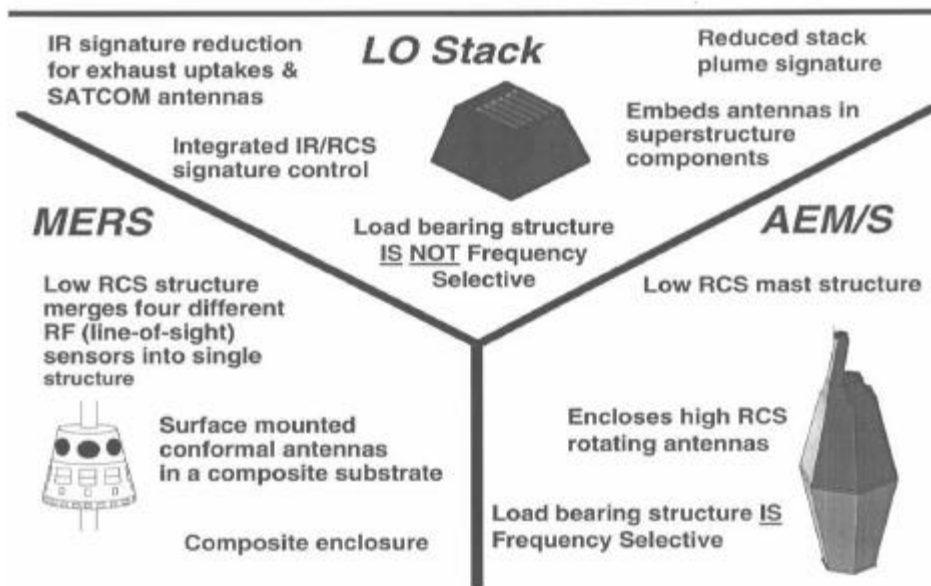

Figure IV-7. Communication Related Advanced Technology Demonstrations

The Low Observable Multi-Function Stack will provide exhaust suppression and imbedded satellite antennas as described in Figures IV-8 and IV-9, [42].

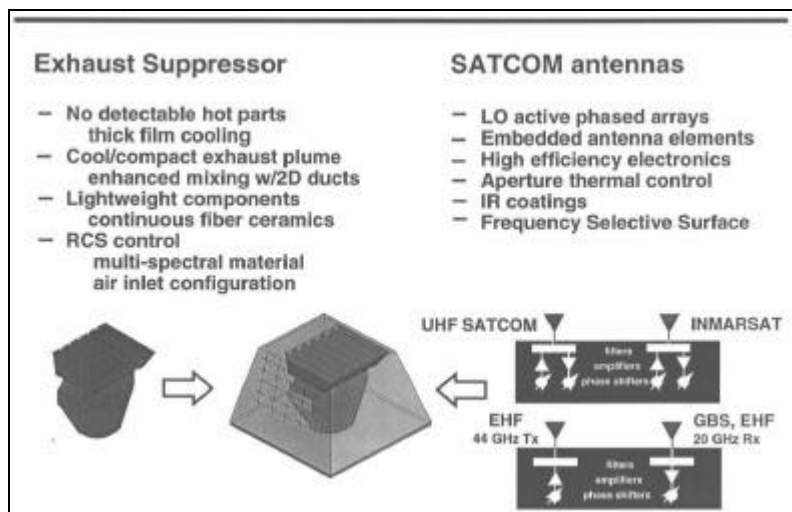
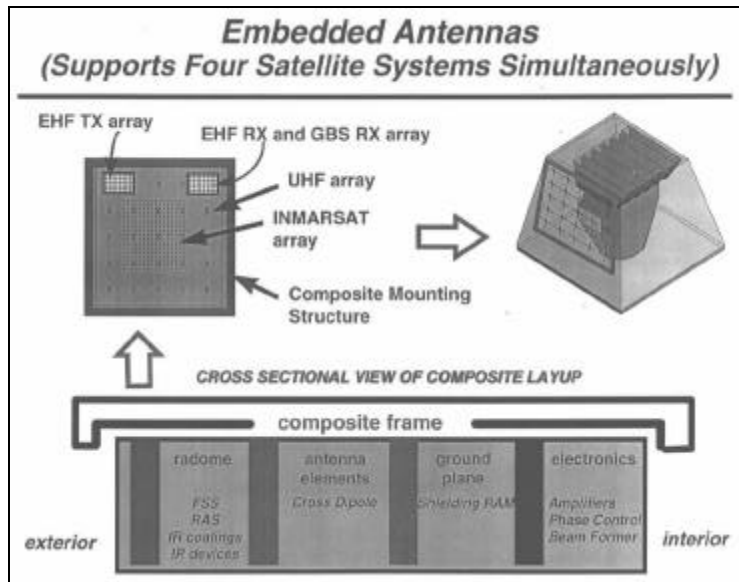
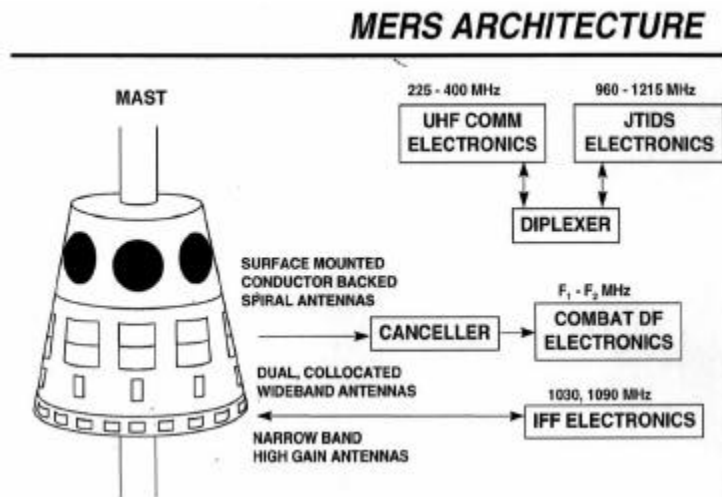

Figure IV-8. Low Observable Multi-Function Stack Exhaust Suppressor and SATCOM Antennas



**Figure IV-9. Expanded View of Low Observable Multi-Function Stack Embedded Antennas**

The Multi-Function Electromagnetic Radiation System (MERS), will provide UHF and Link 16 Line-of-Sight (LOS) communication antennas as well as Identification Friend or Foe (IFF) and Combat Direction Finding Equipment, Figure IV-10 [42].



**Figure IV-10. Multi-Function Electromagnetic Radiation System (MERS) Architecture.**

Our interest in the Advanced Enclosed Mast Sensor System (AEM/S), which was designed to cover existing mast mounted equipment on present surface ships, is the integrated VHF/UHF/IFF communications antenna and integrated HF Broadband Antenna concept. The top of the mast holds an extended integrated antenna for VHF, UHF and IFF communications.. This mast is near the top to optimize line-of-sight distance, Figure IV-11, [43]. The Upper half of the enclosed mast is hexagonal with a ten degree angle. Investigations are currently ongoing at NRaD, San Diego to see if an integrated HF broadband antenna, 2-30 MHz can be imbedded, possibly in the corner structures, Figure IV-12, [43].

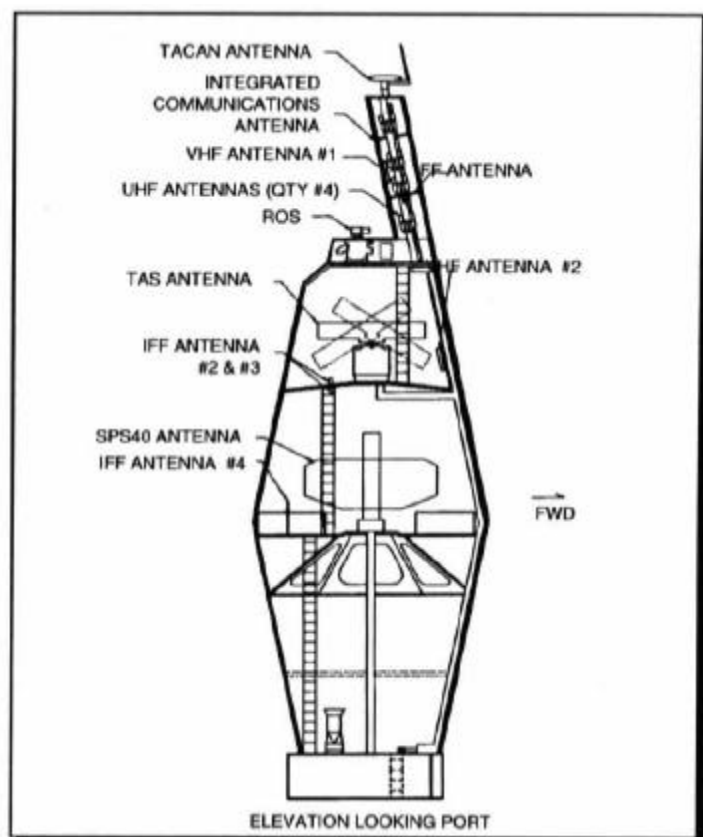

**Figure IV-11. Advanced Enclosed Mast**



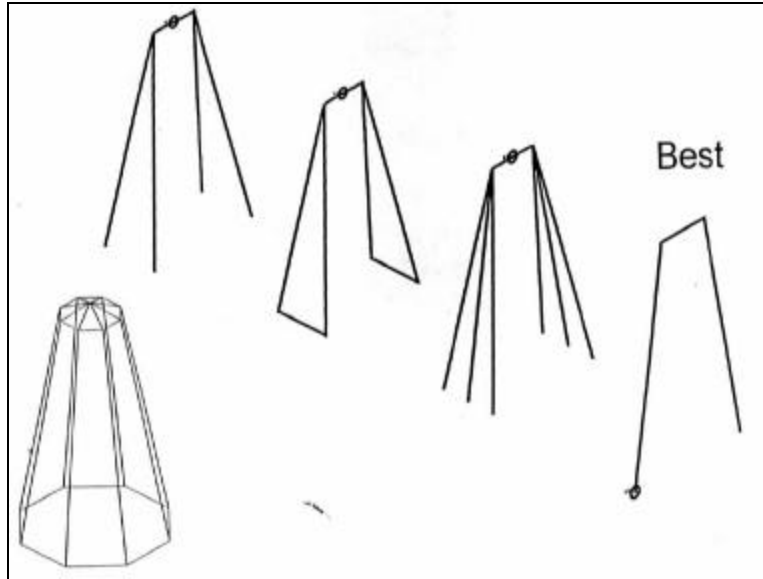

**Figure IV-12. Example of Integrated HF Broadband Antenna, Octagonal Orientation.**

**a. Long Haul Communications [44]**

Satellite communications have become the primary global means of communication with HF communications as a back-up. Satellites have inherent disadvantages including electronic vulnerabilities, high costs, coverage limitations, and bandwidth/load limitations. No single long-range communications medium can meet all shipboard communications requirements and these limitations have spurred improved HF communications programs, Table IV-7, [42].

<ul style="list-style-type: none"> <li>• HF Improvement program (HFIP)</li> </ul>
<ul style="list-style-type: none"> <li>• Link 11 Improvement Program (LEI - Link 22)</li> </ul>
<ul style="list-style-type: none"> <li>• HF Automatic Link Establishment System</li> </ul>
<ul style="list-style-type: none"> <li>• Communications Support System (CSS)</li> </ul>
<ul style="list-style-type: none"> <li>• HF multimedia communications systems</li> </ul>

**Table IV-7. HF Communications Programs**

HF communications operate in the 2-30 MHz frequency range primarily for ship-to-ship and ship-to-shore connectivity. Typical bandwidths are 3 kHz for voice, 75bps for teletype (TTY) and 2400 bps for data. HF propagation is subject to ionospheric fluctuations varying with the time of day, season, sunspots, multipaths and fading, but is relatively free from atmospheric noise. Optimum HF performance has been attained through improved antenna performance, use of single-side-band (SSB) modulation to preserves bandwidth, efficient use of transmitter power, and propagation prediction methods. HF improvements are striving for higher data rates, improved point-to-point link establishment, adaptive frequency selection, better shipboard radio resource applications, Anti-Jam (AJ) capabilities, and Low Probability of Intercept (LPI), [42]. Table IV-8 is a survey of required HF communication equipment for the *Arsenal Ship* and the associated antenna systems.

<b>ARSENAL SHIP HF EQUIPMENT</b>
• AN/URC-131A(V) High Frequency Radio Group (HFRG)
• AN/TRQ-42 Tactical Frequency Management System (TFMS)
• AN/URT-23(E) HF Transmitters
• R-2368B/URR HF Receivers
• Broadband Three-Wire, Twin-Fan, Light Weight Communications Antenna (LWCA)
• AS-2537A/SR HF Narrowband Monopole Antennas
• HFRG Receive Antennas
• HF Transmitter Multicouplers
• HF Receive Multicouplers
• AN/SSQ-33 Ships Automated Control System (SACCS)

**Table IV-8. Arsenal Ship HF Communications Equipment**

**b. HF Communication Component Descriptions:**

- (1) AN/URC-131A(V) High Frequency Radio Group (HFRG), [45]

The AN/URC-131A(V) High Frequency Radio Group (HFRG) replaces existing shipboard manually tuned/controllable and rigid HF communications systems with a modern, agile communications system that is remote controllable/tunable, data capable and easier to operate and maintain. The HFRG forms part of the *Arsenal Ship* Exterior Communications System (ECS), and when interfaced with other equipment supports interrupted continuous wave (ICW), voice, teletype and digital data communications

services. The HFRG supports tactical and Long-Haul (LH), full duplex, half duplex, and simplex, ship-to-ship, ship-to-submarine, ship-to-aircraft and ship-to-shore communications. The HFRG is capable of receiving signals in the frequency range 14 kHz to 30 MHz and transmitting signals in the frequency range 2-30 MHz. The HFRG is controlled remotely by the Ship Automated Communications Control System (SACCS) over a MIL-STD-1553B digital time division command/response multiplex data bus, and RS-422 buses, or locally from the equipment front control panels.

The HFRG consists of three subsystems: The transmit subsystem, the receive subsystem and the control/monitor subsystem. These subsystems replace the individual narrowband strings of receive and transmit equipment. The HFRG supports various configurations and quantities of transmit/receive circuits. The HFRG can support various transmit powers (4,8,12 kW), antenna numbers, different peak envelope power (PEP) rated Broadband Power Amplifiers (BBPA), and 1kW narrowband transmit circuits.

Modes of Operation: The modes of operation for the transmission and reception of user information are Lower Side Band (LSB), Intermediate Side Band (ISB), Upper Side Band (USB), Frequency Shift Keying (FSK), Continuous Wave (CW), Amplitude Modulation (AM), LINK-11-ISB and LINK-11-USB. The transmission of FSK, CW, AM, and LINK-11-USB are in the USB mode. Full carrier is used in the AM mode and the carrier is fully suppressed when transmitting in any other mode of operation. Reduced carrier, when required, is selectable. The reception of FSK, CW, AM, and LINK-11-USB are in the USB mode. The reception of AM is band-limited by the USB filter. The appropriate receive subsystem automatic gain control (AGC) is used for each mode of operation.

Transmit Subsystem: The *Arsenal Ship* (information source) generates a baseband signal which is routed by the ships transmitter switchboards to the HFRG transmit subsystem, where the signal is modulated, in the USB, LSB or ISB mode, by an exciter to provide an output in the 2-30 MHz frequency range. Each transmit circuit has its own exciter. The output signal of each exciter is amplified by the Broad Band Power Amplifier (BBPA) and routed to the appropriate broadband transmit antenna. The baseband signals are also routed to the narrowband antenna tuner-coupler which matches the output of the amplifier to the 35 foot whip antenna. The transmit subsystem operational configuration is established in response to commands from the SACCS, and the transmit subsystem reports when the system is configured and also reports detected failures. The *Arsenal Ship* is configured with 4kW allocated transmit power for 4 broadband transmitters and 2 1kW narrowband transmitters. (Comparison: YORKTOWN is configured with 4kW transmit power for 7 broadband transmitters and 2 1 kW narrowband transmitters.)

Receive Subsystem: Radio Frequency (RF) signals between 14 kHz and 30 MHz are received by small antennas provided with the system. These antennas are physically smaller than the transmit antennas and electrically small at the lower frequencies. The RF signals from the antenna are distributed to the appropriate receiver, and the signal is demodulated to provide a baseband output which is routed by the surface ship receiver switchboards to the appropriate user (information sink) within the ECS. The receive subsystem is established in response to commands from the SACCS and the receive subsystem reports when the system is configured and also reports detected failures.

(Comparison: YORKTOWN is equipped with 3 racks of 6 receivers (18 channels total). Two receivers cover 14 kHz-30MHz and 16 receivers cover 2-30MHz.)

Control/Monitor Subsystem: Remote control, performance monitoring, test, operator interface and display of the operational characteristics of the HFRG are the functions of the CMS. The transmit and receive subsystems are capable of configuring and reporting operational characteristics in response to commands from the CMS over dual-redundant RS-422 multi-drop buses. The remote control, operator interface, and display functions are performed by the CMS. With SACCS installed, it performs the remote control, operator interface and display functions. The CMS automatically assumes those functions if the SACCS fails.

The HFRG provides a major improvement in time required for circuit activation/deactivation and significantly reduces man-hours required for system maintenance and repair. The HFRG significantly reduces the workload of communication and maintenance personnel by providing remote-controlled, automatically-tuned circuit configuration and activation, extensive self-test capabilities and diagnostic programs. Using previous manually tuned HF systems, each circuit required approximately 5-7 minutes to tune. The HFRG requires 30 seconds for one person to reconfigure one or multiple circuits using the CMS/SACCS.

(2) AN/TRQ-42 Tactical Frequency Management System  
(TFMS), [42]

The Tactical Frequency Management System (TFMS) uses a Chirpsounder which conducts HF sounding of the ionosphere to detect the best HF communications

frequencies, Figure IV-13, [42]. The TFMS improves the quality and reliability of HF circuits by providing continuous measurement and display of the best HF communications frequencies as the ionosphere changes.



**Figure IV-13. AN/TRQ-42 Transmitter and Receiver**

(3) AN/URT-23(E) HF Transmitters, [42]

The AN/URT-23E transmitter is an ISB HF radio set designed for reduced and suppressed carrier applications in the 2-30MHz frequency range. It operates in AM voice, CW, RATT (radio teletype ) and ALE (Automatic Link Establishment) modes with the automatic antenna coupler group AN/URA-38. The AN/URT-23(E) has improved coding and waveforms and a MIL-STD-1553B bus. ALE is a method of establishing HF point-to-point communications using selective calling, hand-shaking, scanning, sounding, polling, and coordination among HF networks conforming to MIL-STD-188-141A for HF interoperability and ALE. Figure IV-14 shows the physically similar AN/URT-23(D) transmitter, [44].

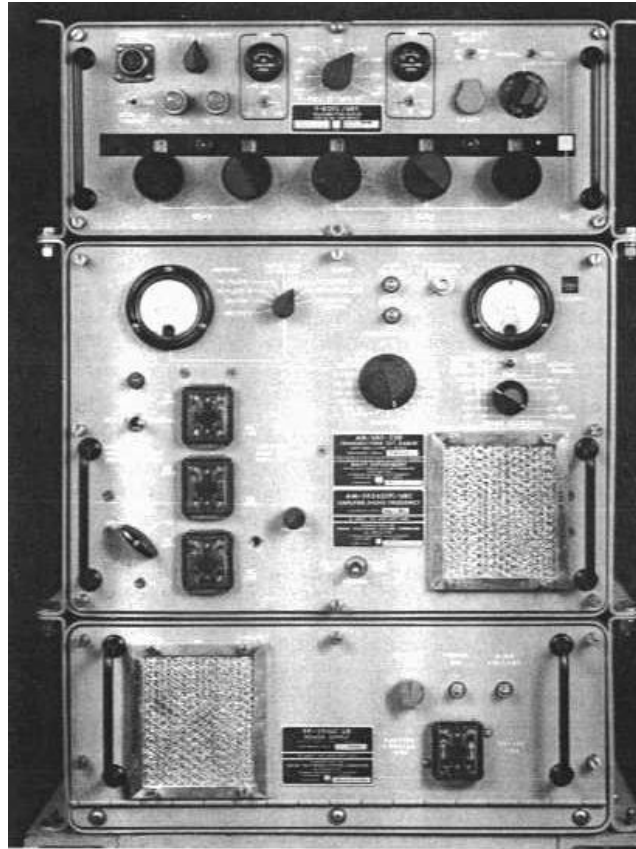

**Figure IV-14. AN/URT-23(D) Transmitter**

(4) R-2368B/URR HF Receivers, [42]

The R-2368B is the standard LF/MF/HF receiver operating in the frequency range 10 kHz-30 MHz, tunable in 1 Hz increments, Figure IV-15, [44]. Its modes of operation include USB/LSB/ 2-USB, CW, AM and FM with fault isolation to a replaceable module/board. The receiver includes a serial two-wire databus remote control with MIL-STD188C, RS-232C or RS-422 formats. LINK 11 operability and internal FSK demodulation with selectable shift and center frequency are standard. The receiver size is 13.3 cm x 48.3 cm x 19.5 cm, weighing 18 kg, with a power requirement of 115 VAC +/- 20%, 47-400 Hz.

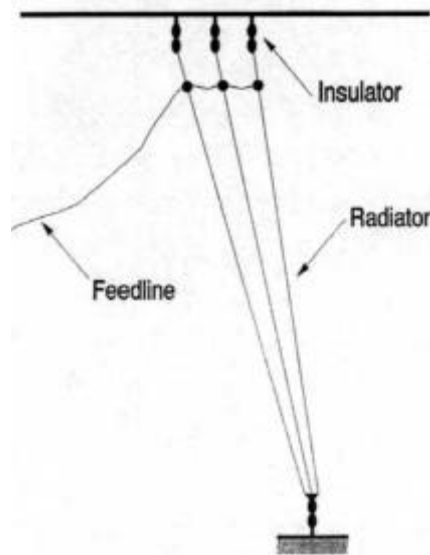



**Figure IV-15. R-2368B/URR HF Receiver**

- (5) Broadband Three-Wire, Twin-Fan, Light Weight Communications Antenna (LWCA) [42]

Fan-type antennas are designed to be nearly omnidirectional operating over a 4-to-1 frequency range with power loss of only 20% due to mismatch. Efficiency is provided by multicouplers used to combine signals from transmitters and receivers for one or more antennas. The LWCA is the antenna for the HFRG transmit subsystem. The LWCA uses a thermoplastic polymer instead of ceramic insulators to improve shock resistance and the overall weight is reduced by using 4.8mm diameter phosphor-bronze wire instead of 7.9mm diameter wire. The *Arsenal Ship* will use the LWCA in a twin fan setup similar to Figure IV-16, [44].



**Figure IV-16. Broadband Three-Wire Light Weight Communications Antenna**

(6) AS-2537A/SR HF Monopole Whip Antennas, [42]

The *Arsenal Ship* has two 35 foot monopole antennas located forward of the aft stack separated by 35 feet to prevent excessive mutual coupling interference between adjacent base tuners if both are transmitting. The normal setup is for one HF monopole to work with the HFRG transmitting the narrowband baseband signal and the other to operate in a receive mode for additional HF applications. The AS-2537A can receive from 14kHz-32MHz and transmit from 2-32 MHz depending on the antenna coupler used with the antenna, [46].

(7) HFRG Receive Antennas, [45]

The HFRG receive antennas are described as physically smaller than transmit antennas, however, no picture descriptions were obtained. Based on the size of the

vessel, it was concluded that the incorporation of this receive group would not present any difficulties.

(8) AN/URA-38 Antenna Coupler Group, [44]

The AN/URA-38 Antenna Coupler Group provides the narrowband tuning for the AS-2437A/SR monopole antenna when using the AN/URT-23(E) HF transmitter.

(9) CU-1772A/SRA-56, CU-1774/SRA-57 and CU-1776A/SRA-58 Shipboard HF Transmitter Multicouplers [44]

HF transmitter multicouplers provide the capability of simultaneously connecting up to four 1kW transmitters into a single broadband antenna, (e.g. LWCA), thereby reducing the number of HF antennas required for effective communication. The CU-1772A/SRA-56 can connect up to four broadband transmitters simultaneously to a single antennas in the 2-6 MHz band, the CU-1774/SRA-57 in the 4-12 MHz band and the CU-1776A/SRA-58 in the 10-30 MHz band.

(10) CU-1789/SRA-49B Shipboard HF Receiver Multicoupler [44]

The CU-1789/SRA-49B HF Receiver Multicoupler provides the capability of simultaneously connecting HF receivers such as the R-2368 into a single broadband antenna such as the HF monopole antenna AS-2537A/SR or LWCA.

(11) AN/SSQ-33 Ships Automated Control System (SACCS), [47]

SACCS provides an advanced ship radio communications control system for the *Arsenal Ship* that features centralized operator control with automated monitoring and reconfiguration. As the local radio network manager installed on the *Arsenal Ship*, SACCS interfaces with the USN multi-ship radio network manager, the Automated Integrated Communications System (AICS). The AICS supports a global secure-level, relational database-serviced computer and communications network manager for the Navy's ship and shore communications control system.

The AN/SSQ-33 uses TAC-3 open architecture, Oracle and UNIX technologies to provide centralized operator control over ship radio communications. SACCS provides automated, reliable, and robust circuit connectivity, HF, UHF, and VHF radio network monitoring and reconfiguration.

**c. VHF/UHF Line-of-Sight Communications [44]**

VHF/UHF communications support ship-to-ship, ship-to-shore, ship-to-air, line-of-sight (LOS) connectivity. The VHF band is between 30 MHz - 300 MHz and the UHF frequency spectrum is 300 MHz - 3 GHz. Navy shipboard communications in the VHF/UHF bands are attractive because smaller antennas can be used than for HF, LOS propagation results in low detectability, the wider bandwidth allows spread spectrum applications, and very low transmission power can be used for limited transmitter range.

Shipboard tactical VHF in the 30 MHz - 88MHz frequency range uses the Single Channel Ground and Airborne Radio System (SINCGARS), while the 108 MHz - 156 MHz spectrum supports ship-shore communications in amphibious operations and land-mobile shore communications. Principal tactical ship-ship communications and ship-

aircraft ECCM circuits operate in the overlapping VHF/UHF 225 MHz - 400 MHz band, while LINK 16, HAVEQUICK II, and some satellite relays occupy 950 MHz - 1150 MHz, Figure IV-17, [44].

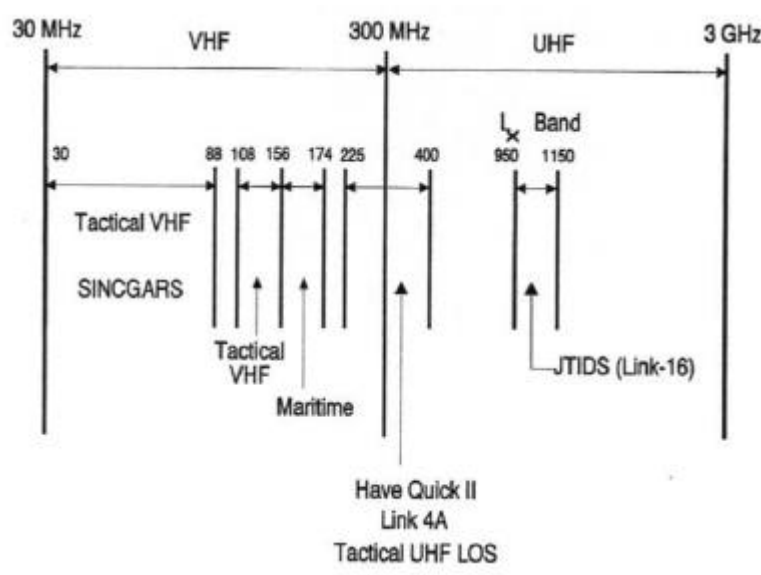

**Figure IV-17. VHF/UHF Spectrum**

In the VHF and UHF bands, it is necessary to pay considerable attention to noise reduction within the equipment itself, since for frequencies above 100 MHz, the noise generated by the receiver front-end amplifier becomes dominant. Receivers are designed so as to perform at as high a S/N ratio as possible. VHF/UHF propagation is not affected by ionospheric reflection and travels in straight lines. Small wavelengths (below 1 meter for frequencies above 300 MHz) may reflect from a ship's structure. Reflected signals interfere with direct LOS signals and cause multipath effects that may weaken the signal. In low altitude applications, reflected multipath signals on the water vary receiver signal strength. Above 400 MHz, transmission resembles transmission of light with shadowing by obstacles, reflection from terrain features, structures and vehicles with sufficient

reflectivity. Wider signal bandwidth than HF allows spread-spectrum techniques and higher data transmission rates (UHF is often used for digital data transmission). Shipboard VHF and UHF receivers are designed for high sensitivity, for a very high range of signal strengths, and for combating interfering signals by utilizing spread spectrum technology. LOS ranges are increased by elevating shipboard VHF/UHF radio antennas. To extend the LOS range, airborne relays are used such as aircraft or UAVs. Table IV-9 is a comparison of LOS ranges and elevation.

Antenna Height	Range
Ship (30m) to Ship (30m)	25-50km
Ship (30m) to Helicopter (300m)	60-90km
Ship(30m) to Aircraft (3000m)	200-240km

**Table IV-9. LOS VHF/UHF Range versus Antenna Height**

(1) AN/VRC-90 SINCGARS - Single Channel Ground and Airborne Radio System [42]

SINCGARS is a joint tactical VHF radio which is a frequency hopping (FH), frequency modulated (FM), spread spectrum system covering the 30 MHz-88MHz frequency band in 25 kHz wide discrete bands. SINCGARS is designed to provide secure voice and data communications in jamming environments. The shipboard VHF SINCGARS is a modified version of the ground-based SINCGARS. The shipboard VHF radio is integrated into the ships exterior communications system, available antenna system and the Single Audio System (SAS), which integrates secure and nonsecure voice interior communications, Figure IV-18, [44].

SINGARS radios consist of transmitter-receiver equipment, antenna/antenna coupler equipment, Communications Security (COMSEC) equipment, Transmission Security (TRANSEC) equipment, and baseband equipment. The *Arsenal Ship* contains the Type II SINGARS VHF radio configuration. Type II SINGARS consists of four circuits with multiple antennas for the heavy traffic anticipated for NSFS. When operated in the single-channel (SC) mode, the four antennas are connected to a Multicoupler (TD-1289). When operated in frequency hopping (FH) mode, the four antennas are connected to four separate power sensors in order to support the FH spread spectrum operation.

The shipboard SINGARS includes four RT-1523 receiver-transmitters as part of the AN/URC-90 SINGARS radio system, Figure XX. The COMSEC/TRANSEC equipment includes a communications encryption device for user traffic and a transmission encryption device for frequency hopping ECCM. The baseband equipment includes the AN/PSC-2 Digital Communication Terminal (DCT), a portable communications message processor for Marine Corp gunfire support, the H-250 handset for voice communications and the Single Audio System. Baseband equipment is connected to the RT-1523 via a 1553B data bus or an RS-232C interface.

The SINGARS System Improvement Program (SIP) of 1996 provides Time Division Multiplexing (TDM), voice and data networking, automatic net radio interfacing, packet radio, forward error correction, reduced synch times and an interface with the Global Positioning System (GPS). The technical specifications of the SINGARS radio are shown in Table 4, [47].

SINGGAR RADIO Technical Specifications
<ul style="list-style-type: none"> <li>Modes: (single channel, frequency hopping, cypher text, plain text, digital data, analogue data, FSIC, retransmission)</li> </ul>
<ul style="list-style-type: none"> <li>Frequency Range: 30-88 MHz</li> </ul>
<ul style="list-style-type: none"> <li>Number of Channels: 2,320</li> </ul>
<ul style="list-style-type: none"> <li>Data Capability: 600 bps - 16 kbps digital plus FSK</li> </ul>
<ul style="list-style-type: none"> <li>Dimensions: 51x119x269mm, weight 2kg</li> </ul>
<ul style="list-style-type: none"> <li>Power Output: 500 mW, 160 mW, 4.5 W, 50 W (with power amplifier)</li> </ul>

**Table IV-10. SINGGARS Technical Specifications.**



**Figure IV-18. SINGGARS RT-1523 Transceiver**

(2) AN/ARC-182 VHF/UHF Radio 30Mhz - 400 MHz [42]

The AN/ARC-182 VHF/UHF multiband/multimode tactical radio for close air support, air traffic control, maritime radio-telephone, military and NATO use. It has 25



kHz spacing in VHF/UHF modes supporting 11,960 channels and can be interfaced via a 1553B data bus or RS-232 serial data channel, Figure IV-19, [44].

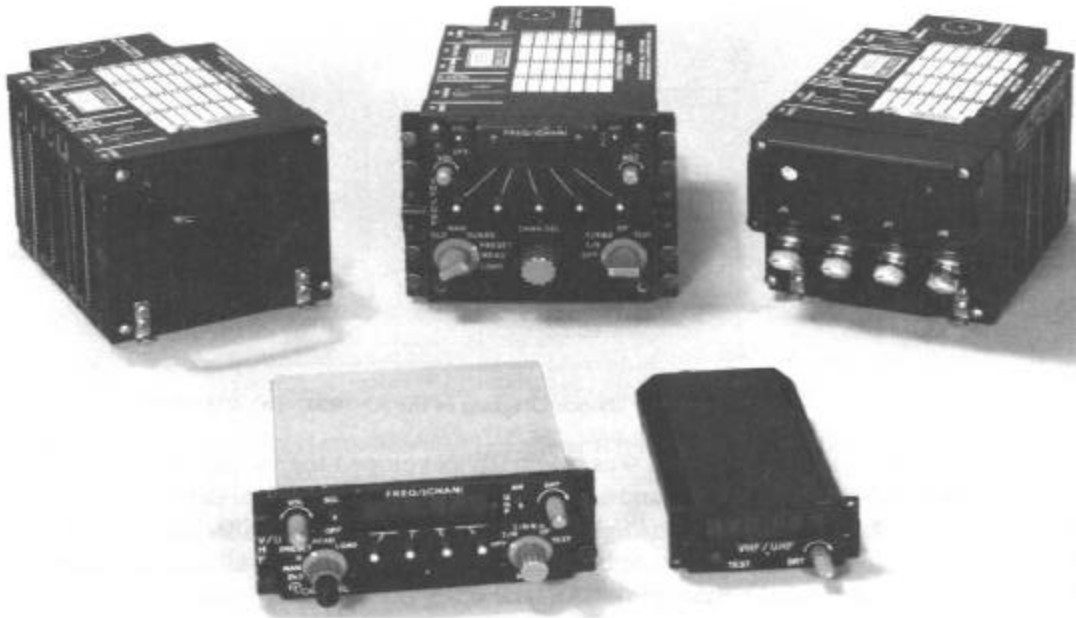

**Figure IV-19. AN/ARC-182 VHF/UHF Radio**

**(3) AN/WSC-3(V)6 UHF LOS Radio [42]**

The AN/WSC-3 is a shipboard UHF LOS radio in the 225 Mhz-400 MHz range. The WSC-3 radio group consists of an antenna coupler, an RT-1217/WSC-3 transceiver and a Quadratic Phase Shift Keying (QPSK) modem which can handle voice, data, TTY LOS and UHF SATCOM communications, Figure IV-20, [44].

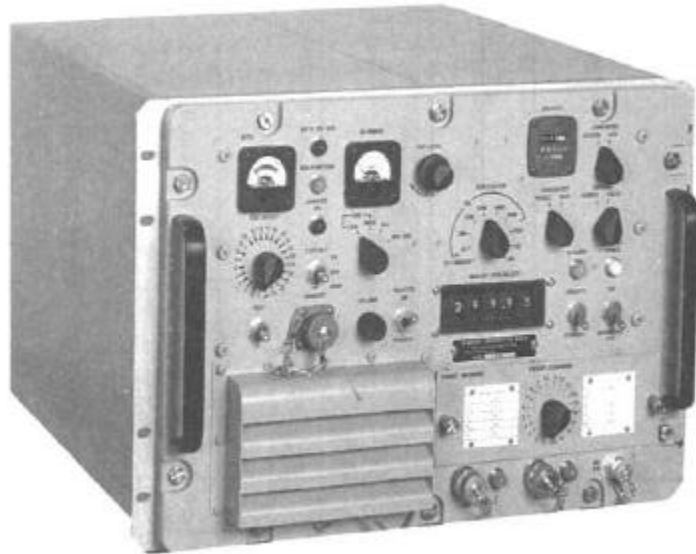

**Figure IV-20. AN/WSC-3(V)6 UHF Transceiver**

(4) AN/URC-93 VHF/UHF LOS Radio [42]

The AN/URC-93 is a Navy shipboard VHF/UHF radio operating in the 225-400 MHz frequency band and consists of an antenna coupler, OR-176(V) transceiver, and a remote controller. The radio group can handle local or remote voice, TTY, data and wideband communications in ECCM and Low Probability of Intercept (LPI) modes, Figure IV-21, [47].

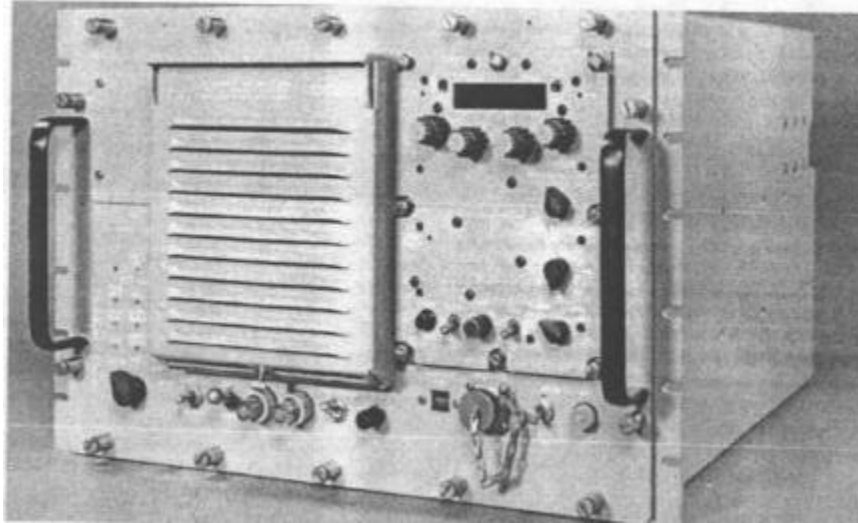

**Figure IV-21. AN/URC-93 VHF/UHF Transceiver**

(5) LINK-16 (JTIDS - Joint Tactical Information Distribution System) [42]

Link 16 is a high capacity Time Division Multiple Access (TDMA) system providing integrated communications, navigation, and identification of friend or foe (IFF). The Link 16 waveform consists of a series of 6.4 us pulses in the 960 MHz - 1215 MHz band with anti-jamming capability using frequency hopping techniques. Link 16 provides ECCM capability for airborne and surface ship platforms, extended range of communications and OTH communications between surface ships using an airborne relay platform. The *Arsenal Ship* contains the Class I terminal for surface ships and uses LINK 16 as a backup to CEC for data communication with the Control Ship.

(6) Global Position System (GPS)

The *Arsenal Ship* uses GPS for precision navigation. The *Arsenal Ship* will have a GPS flush mounted antenna at each corner of the forward upper deck superstructure,

tilted at 10 degrees from vertical and electronically switched for the maximum receive signal, Figure IV-22, [48]

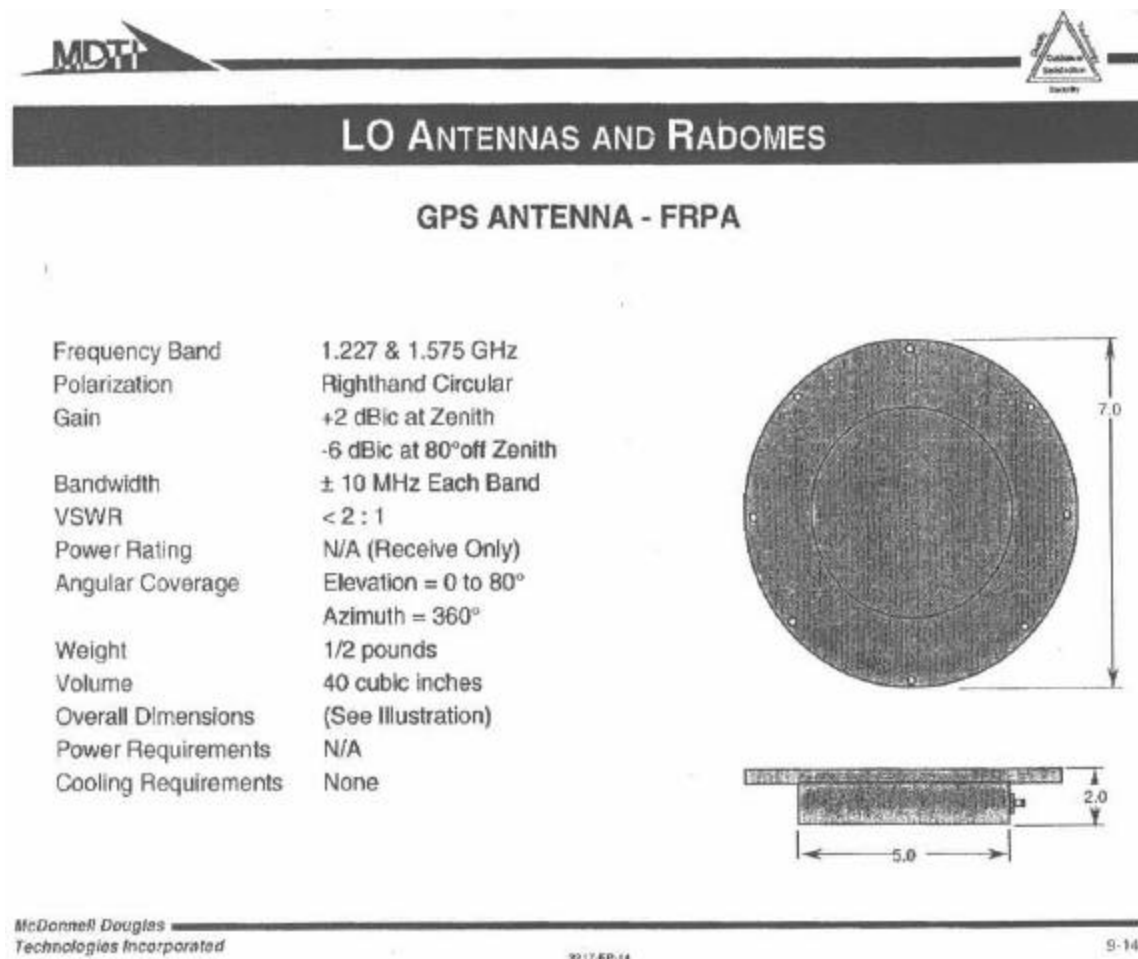

**Figure IV-22. GPS antenna**

- (7) AN/USQ-123 Common High Bandwidth Data Link (CHBDL) [44]

The Common High Bandwidth Data Link is a microwave LOS link supporting imagery data communications from airborne platforms such as a reconnaissance aircraft to ships. The CHBDL provides full duplex microwave digital data links between shipboard and airborne terminals in the X and Ku band frequencies (9.7 GHz - 10.5 GHz

and 14.4 GHz - 15.5 GHz). Currently used by aircraft carriers for acquisition of sensor signals from airborne reconnaissance aircraft and other data link-equipped aircraft, the system has a downlink capability of 10.71 Mbps, 137 Mbps, and 274 Mbps and an uplink rate of 200 kbps. This system is included as a consideration for a possible high data rate link capability between the control ship and the *Arsenal Ship*, perhaps as a backup for CEC. The higher data rate from the control ship to the *Arsenal Ship* could provide the weapon initialization data and updates while the lower data rate could provide the *Arsenal Ship* status messages. This system was not placed on our design because of the backfit cost required to fit all ships that might act as Control Ships with CHBDL. However, with the *Arsenal Ship* as part of a battlegroup with the capability to use aircraft as the downlink media, this system may bear consideration. The technical characteristics of the CHBDL AN/USQ-123(V) Transceiver are shown in Table IV-11.

<ul style="list-style-type: none"> <li>• Frequency: X-band, Ku-band</li> </ul>
<ul style="list-style-type: none"> <li>• Data Rate: Uplink - (200 kbps)</li> <li style="padding-left: 40px;">Downlink - (10.71 Mbps, 137 Mbps, and 274 Mbps)</li> </ul>
<ul style="list-style-type: none"> <li>• Modulation: Uplink - (BPSK-binary phase-shift-keying)</li> <li style="padding-left: 40px;">Downlink - (Offset QPSK-quadrature phase-shift-keying)</li> </ul>
<ul style="list-style-type: none"> <li>• Antenna: Two 1-meter dish antennas</li> </ul>

**Table IV-11. Technical Characteristics of CHBDL AN/USQ-123(V) Transceiver**

**d. VHF/UHF Antennas**

VHF/UHF LOS antennas are small, with VHF antennas ranging from 1.5-3 meters and UHF antennas sized from 60 cm - 1.5 m. These VHF antennas are placed topside, mounted on the *Arsenal Ship's* two masts supporting the CEC antennas. They are internal, enclosed within a frequency selective structure, mounted around the load bearing support. The UHF LOS communication antennas are representative of low observable UHF antennas available from McDonnell Douglas Technologies Incorporated. Eight 32 inch diameter, flush mounted antennas symmetrically located around the deck house will provide UHF LOS connectivity, Figure IV-23, [48].

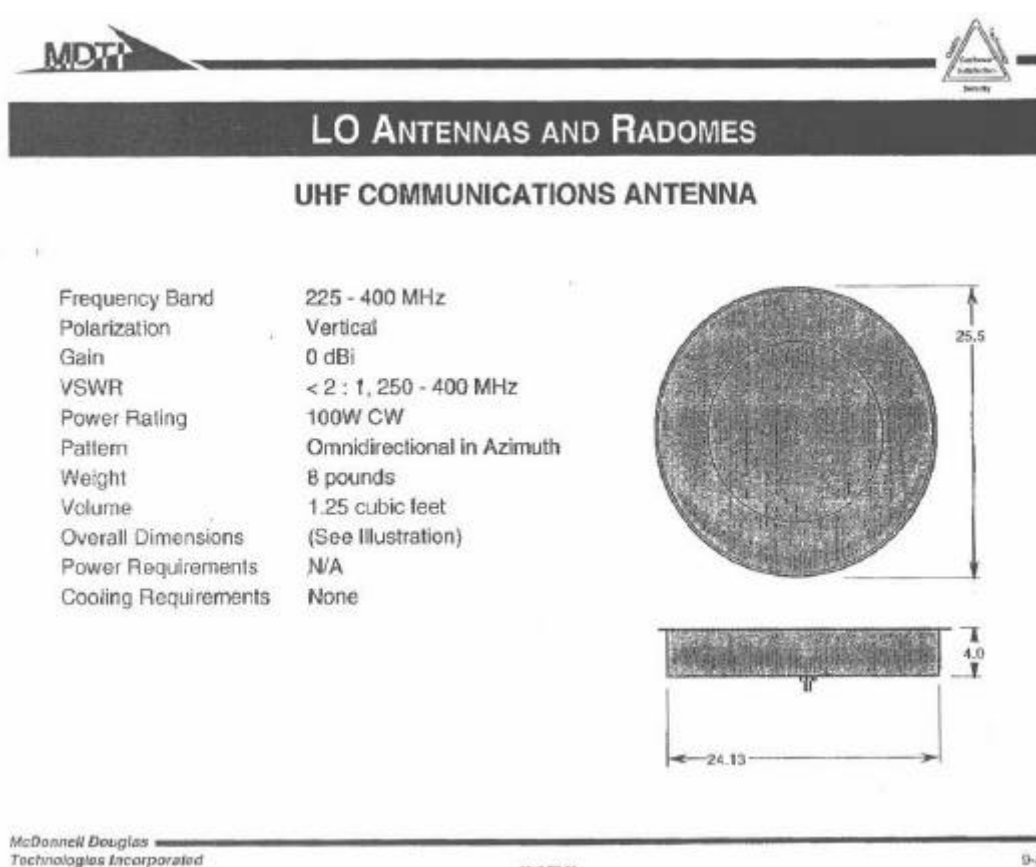

**Figure IV-23. Low Observable UHF Communications Antenna**

The LINK 16 and IFF antennas are flush mounted and located adjacent to the eight UHF antennas. The eight antennas are 12 inches in diameter and time share between Link 16 and the 1030 MHz, 1090 MHz IFF frequency, Figure IV-24, [48].

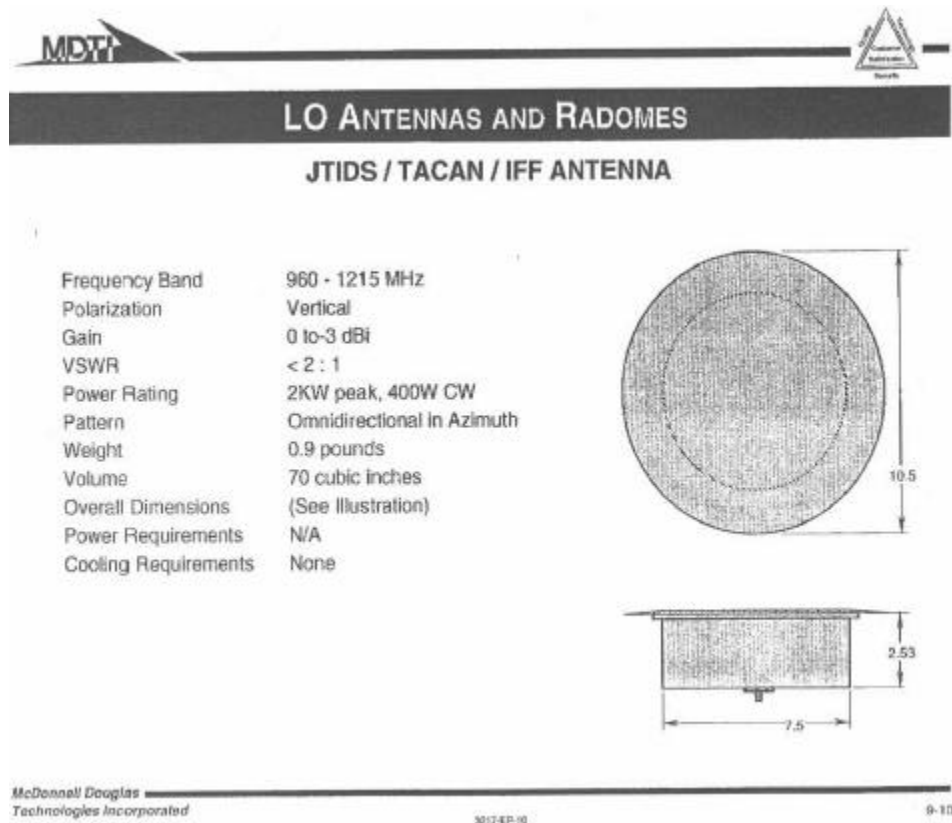

**Figure IV-24. Low Observable LINK 16/IFF Communications Antenna**

(1) VHF/UHF Antenna Coupler CU-1559 [44]

The CU-1559 antenna coupler is a two port impedance matching device and isolation network that allows duplex operation of two VHF/UHF transceivers. The CU-1559 may be used to couple two UHF transmitters to one antenna and two VHF/UHF receivers to a second antenna.

**e. UHF Fleet Satellite Communications (FLTSATCOM) [44]**

UHF satellite communications (SATCOM) are provided by the combination of FLTSAT (Gapfiller Satellites), and LEASAT (Leased Satellites), to provide global FLTSATCOM coverage between 76° N and 76° S. Four FLTSAT equatorial satellites provide coverage with ten 25 kHz channels dedicated for Navy use. Each 25 kHz channel has a separate transmitter with channel one carrying Fleet Broadcast transmissions. Four LEASAT satellites, in service since the 1980s, each provide one 500kHz, seven 25kHz, and five 5kHz repeater channels. The seven 25 kHz channels are dedicated to Navy use with channel one providing Fleet Broadcast and the other six providing UHF SATCOM with or without demand assigned multiple access (DAMA) equipment.

The UHF follow-on (UFO) Satellite Communications System is the replacement system for the FLTSATCOM network. The FLTSATCOM satellite network was originally intended to have a useful service life of five years, but has more than doubled its intended design life with the first launched in 1978. The Navy requires UHF satellite circuits to support the Navy's everyday administrative and tactical communications. The UHF follow-on program is designed to provide reliable and redundant tactical satellite communications well into the future. Eight satellites with one orbital spare will provide near-global coverage between 71° N and 71° S and are completely compatible with the existing FLTSATCOM satellites. The last three UFO satellites will include the Navy's FLTSAT EHF Package (FEP) which will add survivable and protected communications in the next higher band of the spectrum, extremely high frequency, (EHF) [49].



UHF FLTSATCOM subsystems will provide a significant part of the communications for the *Arsenal Ship C<sup>3</sup>I* (Command, Control, Communications and Intelligence), Table IV-12.

<b>FLTSATCOM Subsystems</b>
• Fleet Satellite Broadcast (FLTBROADCAST)
• Common User Digital Information Exchange Subsystem / Naval Modular Automated Communications Subsystem (CUDIXS/NAVMACS)
• Officer-in-Tactical Command Information Exchange Subsystem (OTCIXS)
• Tactical Intelligence Subsystem (TACINTEL)
• Tactical Data Information Exchange Subsystem (TADIXS)
• Secure Voice Subsystem (SECVOX)
• Teletypewriter Subsystem (TTY)
• Submarine Satellite Information Exchange Subsystem (SSIXS)

**Table IV-12. Fleet Satellite Communications Subsystems**

Fleet Broadcast supports the transmission of broadcast one-way message traffic normally operating on channel one. The channel has 15 subchannels each operating at 75 bps with subchannels integrated into a time-division multiplexed (TDM) data stream of 1200 bps. Primary transmission from the shore station to the satellite is a direct-sequence spread-spectrum SHF uplink to provide jamming protection with a UHF downlink. A second channel operating on UHF for both the uplink and downlink provides a backup capability. This backup channel is normally assigned to secure voice transmission. Shipboard subscribers receive the UHF broadcast signal that is then demodulated and demultiplexed. The individual data streams are sent to the Naval Automated

Communications System (NAVMACS) and the Tactical Intelligence (TACINTEL) processors for screening prior to teletypewriters. Weather data and General Service (GENSER) data are sent directly to teletypewriter equipment. Messages in the FLTBROADCAST use formats that adhere to the Joint Interoperability of Tactical Command and Control System (JINTACCS) standards, the U.S. Message Text Format (USMTF), the Joint Army, Navy, Air Force Publications (JANAP) and the Allied Communications Policies (ACP) 121 and 127.

Common User Digital Exchange Subsystem (CUDIXS) is a shore-based processor suite that provides message traffic processing and transmission control. The Naval Modular Automated Communications Subsystem is the ship-based subscriber terminal and processing system that transmits, receives and processes messages. NAVMACS processes the CUDIXS messages and operates interactively with the ship message processing and distribution system (MPDS). CUDIXS/NAVMACS is a functional replacement for ORESTES TTY network. It provides improved operational message throughput rates, increased traffic volume and better link reliability. Each subscriber to a CUDIXS net is assigned an identification number (ID) that is recognized by the CUDIXS and NAVMACS processors. The NAVMACS processor forwards only screened messages addressed to the ID subscriber. The processor automatically sends the messages to the proper end equipment, either a teletypewriter, printer, or recorder. The NAVMACS processor is shown in Figure IV-25, [44].

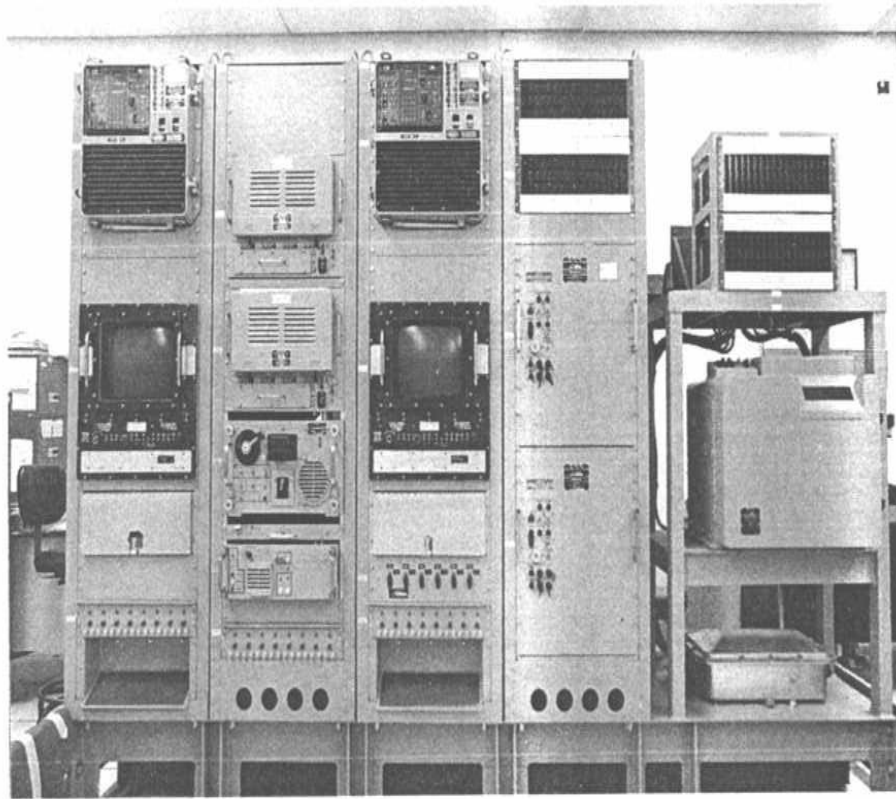

**Figure IV-25. NAVMACS Processor**

The Officer-in-Tactical Command information Exchange Subsystem (OTCIXS) supports full duplex communications to the Battle Group (BG) for command and control (C<sup>2</sup>) and over-the-horizon targeting (OTH-T). The OTCIXS circuit carries TTY message traffic and formatted messages for tactical data processor (TDP) operation. The TDP capability supports the exchange of surveillance formatted track data and targeting data among BG platforms.

The Tactical Intelligence Subsystem (TACINTEL) supports the transmission of special intelligence (SI) information. This subsystem has an automated message processing system and is used for the transfer of information via satellite in a controlled

environment. A 25 kHz channel is allotted to TACINTEL which is structured similar to OTCIXS with up to 23 subscribers in each satellite footprint.

The Tactical Data Information Exchange Subsystem (TADIXS) supports broadcast transmission of TDP data from shore sites to the fleet. TADIXS-B is raw data that uses the Tactical Receive Equipment (TRE). The TRE is a computerized message processing system that demodulates, decodes, decrypts, and processes the TADIXS-B transmissions. The information is data or messages in the Over-the-Horizon Rainform Gold format. The TRE screens duplicate messages and filters them according to user-specified parameters

The Secure Voice Subsystem (SEVOX) supports shore-to-ship, ship-to-ship, and ship-to-shore voice transmission. The narrowband voice (3 kHz channel) is digitized using a vocoder, producing a 2400 bps data stream that is encrypted. The SECVOX subsystem uses push-to-talk half-duplex transmission over a 2400 bps FLTSATCOM channel on each of the four satellites. SECVOX channels on the satellites are dedicated and when DAMA is used, a dedicated time slot is available.

The Teletypewriter Subsystem (TTY) ORESTES uses the FLTSATCOM to provide a reliable beyond-line-of-sight (BLOS) TTY capability via satellite. The ORESTES subsystem provides a full period and on-call tactical and report-back TY circuits that serve as backup for the other networks (e.g. CUDIXS/NAVMACS and TACINTEL).

#### **f. UHF FLTSATCOM Equipment [44]**

There are currently two shipboard UHF FLTSATCOM receivers in use. One is the stand-alone AN/SRR-1A and the other is the receiving section of the AN/WSC-3 UHF transceiver. The AN/SSR-1A receiver is installed aboard most surface ships and receives the FLTBROADCAST message traffic.

The AN/SSR-1 receiver drives TTY equipment and consists of antennas, amplifier-converters, the MD-900 combiner-demodulator, and the MD-1063 demultiplexer.

(MD-900 Demodulator, TD-1063 Demultiplexer, SRR-1 antenna and receiver equipment)

The AN/WSC-3 is used for receiving UHF LOS communications and SATCOM. The AN/WSC-3 transceiver has two built-in demodulators for DPSK data rates from 75-9600 bps, FSK at 75 bps and AM or FM voice modulation. The transmitter segment generates 30 W RF output for AM and 100W for FM, FSK, DPSK. It can support AM narrowband and wideband as well as FM narrowband operations, AM voice and SECVOX, PSK data at 75, 300, 1200, 2400, 4800 and 9600 bps, and FSK at 75 bps. The AN/WSC-3 is tunable to 7000 channels at a 25 kHz spacing.

#### **(1) UHF FLTSATCOM Antennas**

The AS-2815/SSR-1 antenna is used for receiving the Fleet Broadcast and is combined with the AN/SRR-1 receiver. A set of four antennas is used to provide full hemispherical coverage and space diversity reception, Figure IV-26, [44]. The *Arsenal Ship* uses a replacement for the SSR-1 antenna, the AS-3439/G low gain antenna with

complete hemispherical coverage. The AS-3439/G is compatible with low data rate and low radar cross section installations, Figure IV-27, [48].

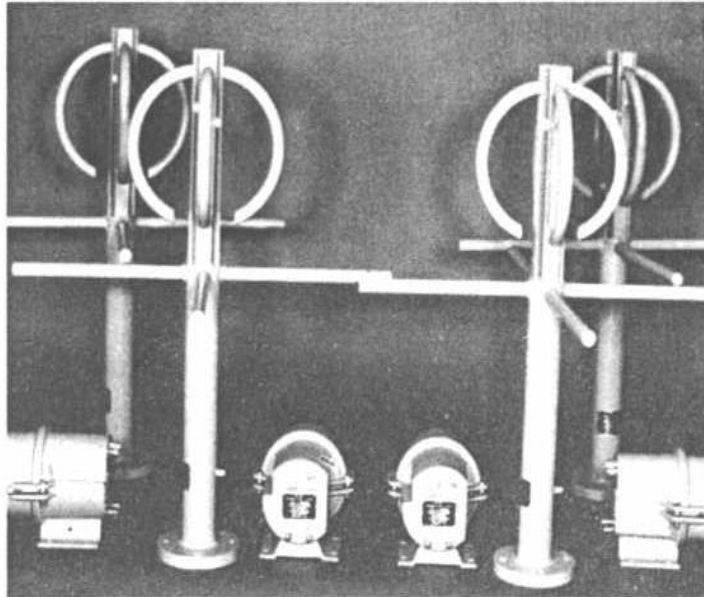

**Figure IV-26. SRR-1 Antenna System**

DM C99-2 (AS-3439/G)  
DM C99-16-1

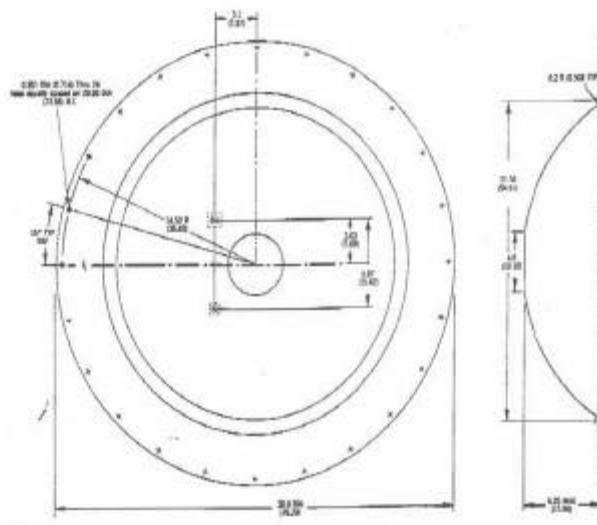

**Figure IV-27. AS-3429/G**

The AS-3018/WSC-1(V) antenna is part of the antenna group OE 82C/WSC-1(V), interfacing with the AN/WSC-3 equipment. The antenna group consists of the antenna and additional equipment for tracking, control, sensing, switching, and preamplification. The AS/3018A/WSC-1(V) antenna consists of a single crossed dipole element recessed within a barrel-shaped drum structure. The antenna size is 1.37 x 0.85m (54 x 33 in) (diameter x depth) and weighs 133 kg (295 lbs). The antenna mount permits 360° azimuthal and 0°-90° elevational orientation with the antenna tracking the satellite automatically. Two AS-3018A/WSC-1(V) antennas are used onboard the *Arsenal Ship* to eliminate superstructure blocking and provide redundancy, Figure IV-28, [44].

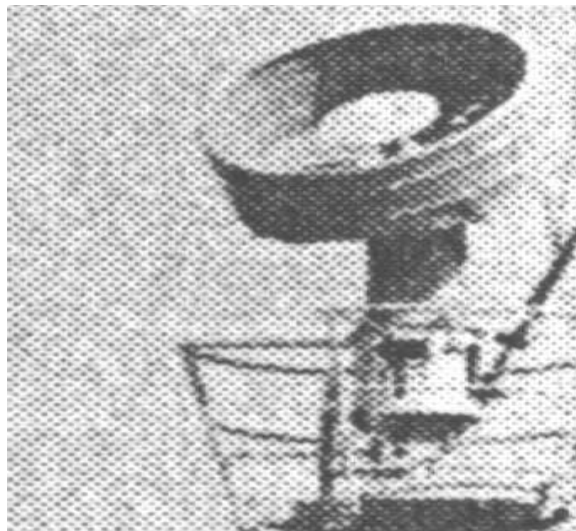

**Figure IV-28. AS-3018/WSC-1(V)**

**g. INMARSAT**

The commercial International Maritime Satellite (INMARSAT) constellation provides point-to-point phone calls ship-ship or ship-shore, on demand, for voice or data connectivity up to 19.2 kbps. Current service is expensive at more than \$5.00 per minute.

Future digital enhancements (INMARSAT B) are projected to improve the quality of service and to lower the cost of a phone call to nearly a dollar a minute by enabling the sharing of a 64 kpbs access among several callers. INMARSAT equipment is installed aboard the *Arsenal Ship*.

**h. SHF Satellite Communications**

SHF Satellite Communications are provided by the Defense Communications Satellite System (DSCS) consisting of eight geostationary satellites. The SHF X-band frequency region offers certain benefits for SATCOM operations as outlined in Table IV-13, [44].

<b>SHF SATCOM Advantages</b>
- Substantial bandwidths are available for allocation, which enables the operation of several 50-, 60- and 85 MHz repeaters on the DSCS satellite.
- High data rates can be supported.
- Propagation is very stable and propagation-related outages (e.g. fading or scintillation) are minimal.
- High-gain antennas with narrow beamwidth can be used, which reduces the probability of interception and provides advantages against jamming.
- Band spreading can be used to provide jamming-resistant communications.
- Interoperability among the services is possible.

**Table IV-13. SHF SATCOM Advantages**

DSCS terminals are capable of 2.0 Mbps throughput and typically get allocated 64 kbps-1.0 Mbps depending on the C4I requirements and the priority of the assigned mission. DSCS provides video-teleconferencing, telemedicine, and data lines for Joint



Deployable Intelligence Support System (JDISS), Joint Maritime Command Information Strategy (JMCIS) subcomponent of the Global Command and Control System (GCCS) and imagery transmission needs. The last three UHF-Follow-On (UFO) satellites will carry a Ku-band SHF high-data-rate broadcast service providing a 23 Mbps service in three spot beams called the Global Broadcast Service (GBS).

SHF shipboard equipment includes the AN/WSC-6 SATCOM terminal, the OE-279/WSC-6 antenna group and the AS-3399/WSC antenna. The WSC-6 antenna is a 1.2m (4-ft) reflector antenna with a Cassegrainian feed. The antenna (including the radome) has a diameter of 1.83 m (72 in) and is 2.20 m (87 in) high weighing 263 kg (580 lbs.), Figure IV-29, [47]. Commercial wideband SATCOM capabilities have been demonstrated by the Navy as Challenge Athena (An NPS Thesis) providing primary imagery, multiple phone lines, teleconferencing, telemedicine, and multiple data lines for C4I systems. Commercial wideband terminals have been programmed for all command ships (LCCs/AGFs, CV/Ns, LHA/Ds, LPDs), and would benefit the *Arsenal Ship*.



**Figure IV-29. AN/WSC-6 SHF SATCOM Antenna**

**i. Cooperative Engagement Capability (CEC)**

The Cooperative Engagement Capability is the *Arsenal Ships* primary method for transferring data for remote firing. The antenna that accomplishes the data distribution is a phased array antenna system that provides omnidirectional coverage. It operates in the high S-band region and consists of a 1000 element antenna providing elevation and azimuth coverage, Figure IV-30, [43]. The *Arsenal Ship* will have two mast mounted antennas for redundancy, one forward and one aft. The antennas are 44 inches in diameter and 14 inches high, Figure IV-31, [50].

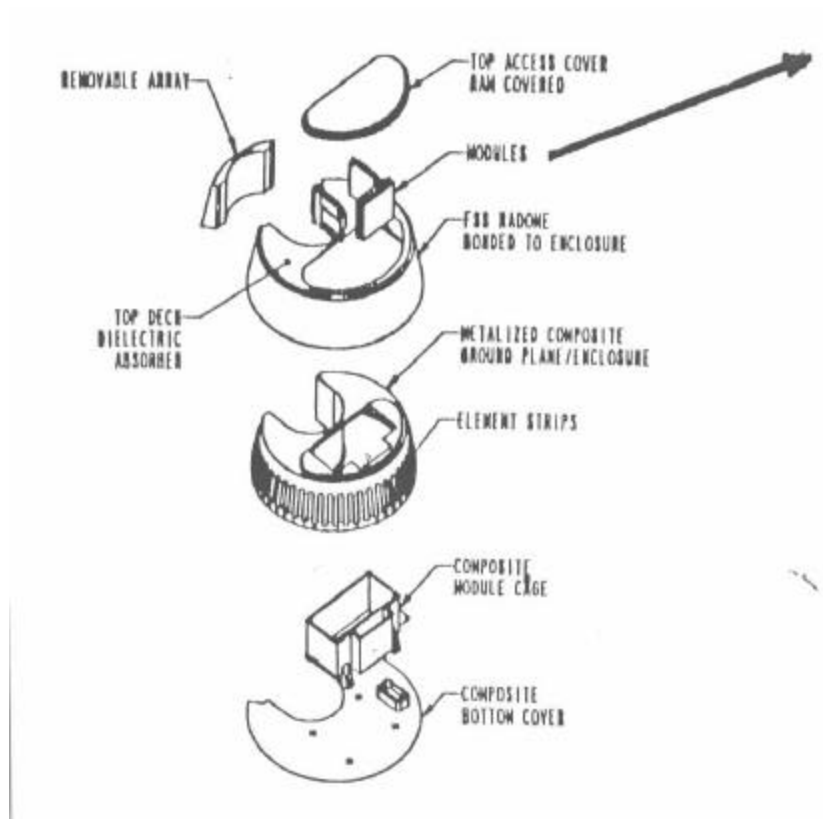

**Figure IV-30. CEC Antenna Schematic**



**Figure IV-31. CEC Antenna Location**

**j. EHF Satellite Communications [44]**

The extremely high frequency band (EHF) provides large bandwidths and allows narrow spot beams that are utilized for substantial anti-jamming protection for military communications. In addition, man-made electromagnetic disturbances (e.g. scintillation's resulting from high altitude nuclear bursts) are not as harmful as at lower frequencies and can be counteracted more easily. The Air Force managed Military Strategic Satellite Relay (MILSTAR) along with the Navy FLTSAT EHF Package (FEP) and UHF Follow-On Satellites-EHF (UFO-E) is part of the modernization of US C<sup>3</sup> (Command, Control and Communications) and will provide worldwide coverage by a constellation of

geostationary and inclined orbit satellites with satellite crosslinking. EHF brings the advantage of protected services. The current implementation of EHF service provides low-data rate channels (2.4 kbps) whose link cannot be interrupted by jamming or nuclear effects. The high frequency provides extremely narrow signal beamwidths enabling users to communicate with a very low probability of intercept or detection (LPI/LPD). The same attributes that make the signal very robust also make the signal very clean, translating into fewer (if any) errors for each transmission. This clean signal is critical for passing TLAM mission data updates (MDUs) or system software updates.

The shipboard EHF satellite terminal is the AN/USC-38 Terminal Equipment which includes a high power amplifier (HPA) and communications equipment group (CEG). The HPA uses 2.6 kW three phase power, 60 Hz, 440 V AC with dimensions 54 in. high, 19 in. wide and 24 in. deep weighing 615 lbs. The CEG cabinet is 72 in. high, 24 in. wide and 30 in. deep weighing 1050 lbs requiring 2.3 kW, three phase, 60 Hz, 440 V, AC power. The ship MILSTAR antenna is a 35 in. diameter reflector with a dual band feed and a rotatable subreflector to provide a conical scan for downlink frequencies, Figure XX. The antenna is enclosed in radome, 56 in. diameter by 60 in. high. The waveguide run from the HPA to the antenna should not exceed 75 feet. One antenna mounting is sufficient for full hemispherical coverage with no superstructure blockage, Figure IV-32, [44].

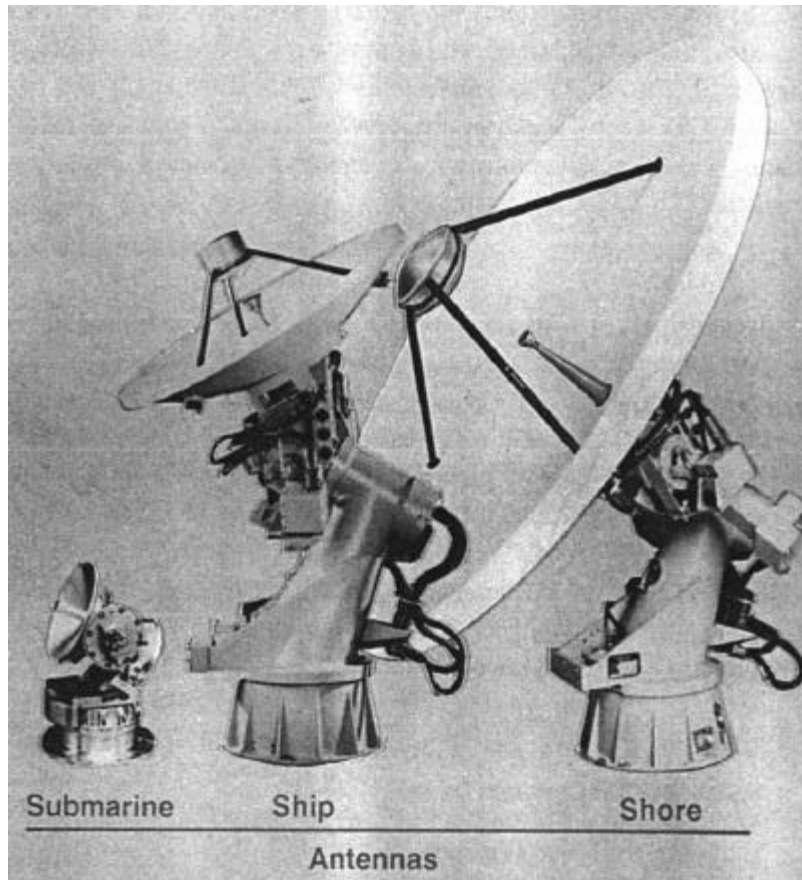

**Figure IV-32. EHF MILSTAR Antennas**

## **2. Naval Telecommunications Automation Programs**

Major initiatives have been undertaken since the 1960s to automate shipboard communications. The Naval Tactical Data System (NTDS), Naval Modular Automated Communication System (NAVMACS), Naval Telecommunications System (NTS) Architecture, Integrated Communications System/Shipboard Communications Area Net (ICS/SCAN), Survivable Adaptable Fiber Embedded Network (SAFENET), Unified Networking Technology (UNT), Communication Support System (CCS) and Copernicus Architecture have all been developed as major steps in the modernization of shipboard suites [43].

The *Arsenal Ship* takes advances in technology to provide a survivable, integrated, redundant, effective, and automated system. The overall goals of reduced manning and cost through application of existing technologies still apply!

### **3. Shipboard Technical Control Systems**

The typical Shipboard Technical Control Facility provides automated technical coordination, testing, activation and deactivation, and report generation. It contains COMSEC equipment, RF and base-band equipment, and a Technical Control room. A typical Shipboard Interior Communications System consists of a Radio Room, Communications Center, and a User Area [43].

The *Arsenal Ship* should take advantage of an automated communications control and switching system for controlling and monitoring the operation of the EXCOMM system and routing communications and weapon control signals. The AN/SQQ-33 SSECMCS and OJ-631 Technical Control Console provides the capabilities necessary to provide full supervisory control over the exterior communications system by two operators. The first performs normal technical control functions, and the second performs back-up functions. The SSECMCS is controlled by the control console and the data terminal set [44].

The AN/SSQ-88 QMCS provides the equipment necessary for a radio operator to monitor the quality of communications circuits. It is a system for on-line testing and is comprised of 11 test devices housed in a single CY-4516 electronic cabinet. The AN/URQ-23 is commonly used as shipboard frequency standard. Tactical Frequency Management Systems such as the AN/TRQ-35 AND AN/TRQ-42 TFMS consist of a “Chirp-sounder” transmitter, receiver, and a spectrum monitor [44].

Antenna multi-couplers can facilitate the use of a single antenna as a signal source for several receivers. It is an accepted practice to install multi-couplers in a cascaded “normal-through” arrangement. The CU-1772A/SRA-56, CU-1774/SRA-57, and CU-1776A/SRA-58 shipboard HF transmitter multi-couplers can simultaneously connect up to four 1kw transmitters into a single broadband antenna [44].

RF patch panels, such as the SB-4249 distribute antenna outputs, multi-coupler inputs and outputs, and receiver RF inputs.

The Black Communications Switch SA-2112A (V)6/STQ provides non-secure automated analog radio-telephone switching system and the Red Communications Switch SA-2112(V)8/STQ provides digital control and switching of plain and cipher audio and data terminals and external radio circuits. The MCS-2000 Interior Communications System provides control and switching of the interior audio and data terminals and the exterior communications system similar to the above mentioned switches [44].

Data switching systems are important to the weapon system in the *Arsenal Ship*. There are several shipboard systems available today (i.e., the SA-4176 Data transfer Switch, the NAVMACS-V AN/SYQ system, and the ON-143 Interconnecting Group). These functions for tactical data links and exterior communications radios, automated message processing and distribution [44].

The *Arsenal Ship* does not have watches dedicated to providing 1MC service. Personnel can carry personal information pads (PIP) that can be remotely-beeped throughout the ship.

#### **4. Interior Communications**

The mind boggling variety of C<sup>4</sup> equipment and procedures found on major Combatants and CJTF staffs requires numerous personnel with advanced training to operate and maintain. The *Arsenal Ship* does not have the luxury of collections of complex systems, but needs smart initiatives to automate the links, circuits, processors, and interfaces required to support the various combat weapon systems.

“Communications automation devices can transfer information and process communications to support information transfer. The shipboard resources available for implementing communications services are radios, modems, encryption equipment, and a Communications Support Service (CSS) controller. The CSS architecture is designed to implement services and resources by using a building block approach and interoperable interfacing component hardware and software systems. CSS can be implemented using current Navy shipboard systems in transferring information among several platforms.” The users are then connected using a LAN [44] (Figure IV-33).



# Arsenal Ship System Architecture

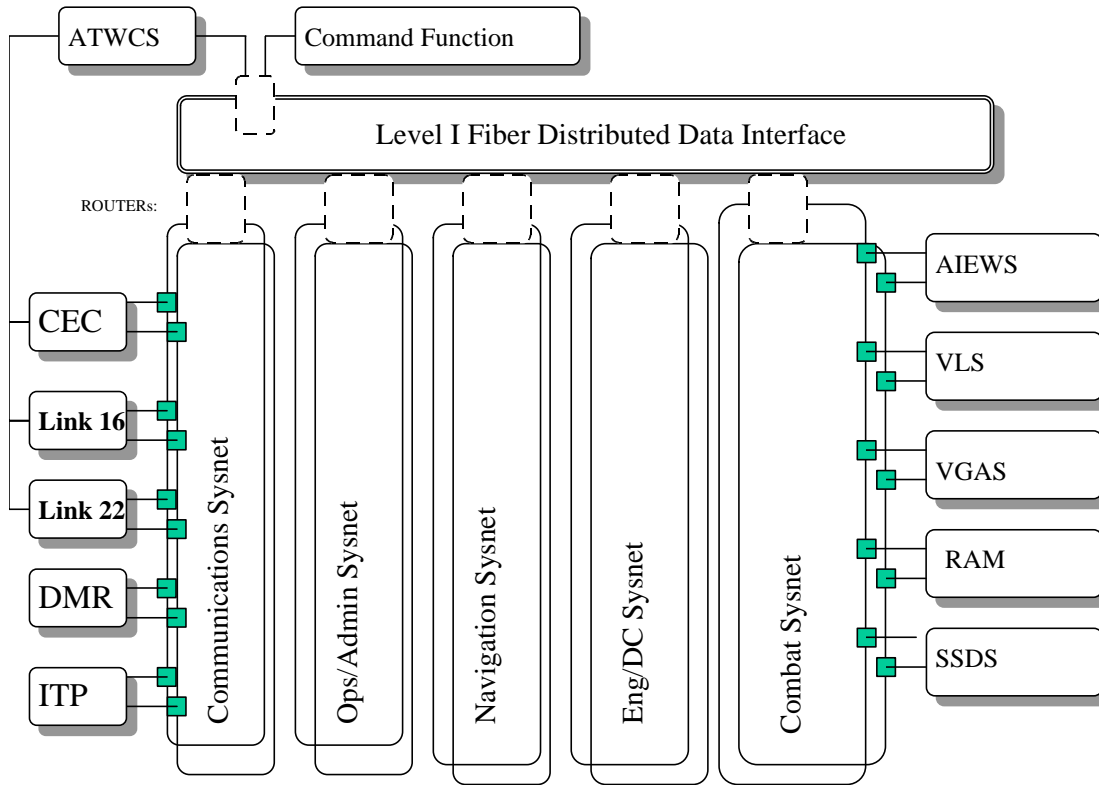

Figure IV-33. CCS Architecture

## 5. Copernicus Architecture

Integral to the development of the *Arsenal Ship* command and control architecture is the Navy initiative called the Copernicus Architecture. The U.S. Navy has developed the Copernicus Architecture for communications systems ashore and afloat. It consists of four entities: Global Information Exchange Systems (GLOBIX), CINC Command Complex (CCC), Tactical Data Information Exchange System (TADIX), and Tactical Command Center (TCC) [44].

## 6. Communication Links

A “Link” is a complete facility and system encompassing equipment and procedures through which communications are accomplished on a permanent basis as opposed to a circuit, which is a communications path established for message transfer on a temporary path. The *Arsenal Ship* supports three permanent links (i.e., CEC, Link-16, and Improved Link-11 (Link-22)). Communications is still maintained through a variety of systems connecting the *Arsenal Ship* to the Information Infrastructure.

CEC is the primary link for sharing composite targeting quality track data. It is envisioned by our team to be the primary link for passing digital information between the Control Ship and the *Arsenal Ship* for weapons employment.

Link 22 is the name of the improved Link 11. It is also called TADIL A and operates at 2.25 Kbps for maintaining the NTDS picture. It is an HF frequency operating between 2-30 MHz. HF has anti-jam capabilities and a low probability of intercept and can incorporate automatic Link establishment techniques. Link 11 operates in a line-of-sight (LOS) mode using UHF. Typical equipment includes HF radios such as the AN/SNC23 or AN/URC-109 Integrated Communication System, UHF radios like the AN/URC-83 Tactical Data Link System, Data Terminal Set such as the MX-512P, and external antenna (i.e., the HF monopole whip antenna AS-2537) [46].

Link 16, previously called Joint Tactical Information Distribution System (JTIDS) and known as TADIL J, operates at 28.8, 57.6, and 115.2 Kbps on UHF between 95 and 115 MHz. Link 16 is a high capacity Time Division Multiple Access (TDMA) system providing integrated communications, navigation, and Identification of Friend or Foe (IFF) capabilities. The waveform consists of a series of 6.4 us pulses in the 969 MHz to

1215 MHz band with anti-jamming capability using frequency hopping techniques. The link provides electronic protection capability, extended range of communications, and over-the-horizon communications between surface ships with an airborne relay platform [46].

## **7. Beyond-line-of-sight Communications**

Beyond-line-of-sight communications (BLOS) can be provided to the *Arsenal Ship* using Wideband SHF SATCOM such as the jam-resistant secure communications (JRSC), FLTSATCOM Broadcast, UHF FLTSATCOM (OTCIX, CUDIXS, and TADIX), and long-haul communications equipment (Commander's Ship-to-shore, HICOM, and Fleet primary). Examples of airborne and shipboard VHF/UHF radios include the 30 watt AN/ARC-159A ship-to-aircraft and the 100 watt AN/URC-93 ship-to-ship radio [46].

## **8. SINGARS**

The U.S. Army, Air Force, Navy, and Marine Corps utilize a tactical VHF radio called the Single Channel Ground and Airborne Radio System (SINGARS), which is a frequency-hopping (FH), frequency-modulated (FM) spread-spectrum system covering the 30 MHz to 88 MHz frequency band in 25 kHz wide discrete channels. The SINGARS is designed to provide secure voice and data communications in jamming environments and is a candidate for the *Arsenal Ship C<sup>4</sup>* for Naval Surface Fire Support missions [46].

The shipboard SINGARS is a modified version of the ground-based SINGARS. In the ECCM Mode, the AN/PRC-119 (man-pack), the AN/VRC-88 (vehicular long-

range dismountable), the AN/VRC-90 (vehicular long-range), and the AN/VRC-92 (vehicular dual long-range for retransmit) radios can be used ashore. In the airborne relay mode, the family of radios that are compatible with the airborne relay mode SINGARS radios are the AN/ARC-201 and the AN/ARC-210 transceiver. Shipboard SINGARS (type II) radios have up to four antennas (AS/3226A) that can support four channels, three for transmitting and one for receiving. When frequency hopping using spread-spectrum operation, the antennas are connected to four separate RF power sensors [46].

## **9. *Arsenal Ship* Combat Systems Communications Protocol**

The *Arsenal Ship* combat system is a complex system consisting of data-processing and communications subsystems, weapon systems, and ESM subsystems. These systems are interconnected connected through a local area network (LAN). Processing systems use standardized data transfer methods such as the Navy Digital System Interconnect Standard (MIL-STD-1397A), which defines the interface characteristics (i.e., physical, functional, and electrical) and the standard interfaces between digital equipment (i.e., computer-to-peripheral, computer-to-computer, and peripheral-to-peripheral). There are three types of NTDS formats to accommodate different data transfer rates (i.e., NTDS fast, slow, and serial) [46].

The *Arsenal Ship* LAN is structured for use by more than one protocol. This balances the conflicting needs of interoperability and performance. EXCOMM systems such as Link-16 and Link 22 use standard message formats for the exchange of digital information.

Modern warships interconnect subsystems with two types of LANs--high capacity token rings and Ethernet (IEEE standard 802.3) which uses a random access method, and high capacity token rings. The military versions are the Survivable Adaptable Fiber-Optic Embedded Network (SAFENET) and the Fiber Distributed Data Interface (FDDI), a high-speed fiber-optic cable token ring using IEEE compatible protocol. Currently, shipboard LANs predominantly utilize rings wired by coaxial or fiber-optic cables. The standard governing the ring LAN is the Token Ring protocol. Fiber-optic cables can accommodate data rates of 100 Mbps, supports up to 240 taps, and have unrelayed transmission ranges of 2 km [46].

“A token ring connects elements of a network in a ring. A token (i.e., data frame with a special bit pattern) moves along the ring in a round robin fashion. When the token arrives at a node, the node can seize the token and send data which passes until the intended receiver intercepts the token, but this method is not as efficient as Early Token Release, where the token is released after transmitting. This would allow the nodes on the LAN to send data and access the ring simultaneously. The Fiber-Distributed Data Interface is a high speed token ring that uses a complex capacity allocation method to accommodate both long data streams and data bursts using synchronous and asynchronous modes [46].”

The communications protocol standards are contained in the International Standard Organization's (ISO) Open Systems Interconnection (OSI) reference model. The government's standard for Open System Interconnection is the Government Open System Interconnection Profile (GOSIP), which allows commercial-off-the-shelf (COTS) products to be used in shipboard communications design [46].

## **H. TOPSIDE DESIGN**

The discussion of the topside design begins with an overview of the factors which control the topside equipment placement, including electromagnetic compatibility, antenna integration, and electromagnetic interference control. The details of the topside design are presented taking into account the controlling factors

### **1. Electromagnetic Compatibility**

#### **a. Topside**

The *Arsenal Ship* cannot afford to be a perfectly stealthy platform. It radiates intermittently through data and voice circuits on various antennas and continually pass information onto the links that it is a part of. It has HF, UHF/VHF, Satcom, and other communications antennas that are transmitters and receivers of RF energy. These antennas interact with each other and with the topside superstructure of the ship at particular wavelengths and signal strengths. Careful planning is required to maintain acceptable levels of electromagnetic interference between antennas onboard the *Arsenal Ship*. Physical placement and proximity between antennas is very important when designing the topside area. Design changes and corrections can be costly in both the financial and temporal domains [46].

Advanced Mast and integrated and embedded antenna concepts greatly reduce EMI problems for the *Arsenal Ship*. But the systems may not be developed sufficiently for use on the Demonstrator. The *Arsenal Ship* uses existing antenna and component systems in order to develop a design with a viable “fall back” option.

“Electromagnetic interference (EMI) is an electromagnetic disturbance that degrades the performance of electronic and electrical equipment due to atmospheric conditions, enemy electronic warfare, or unintended intermodulation effects. Electromagnetic compatibility (EC) refers to the ability of electronic and electrical systems to operate under their intended circumstances without undue degradation due to unwanted EMI. Electromagnetic radiation hazards exist to personnel, fuels, and ordnance (i.e., HERP, HERF, and HERO) [46].”

The main interference sources to the HF band comes from man-made noise followed by atmospheric and cosmic conditions, while the major contributors to VHF, UHF, SHF, and EFE band noise comes from galactic, solar, and atmospheric sources. Man-made noise is a mixture of impulse noise from machinery-- motors and generators, engines, and impulse noise from switch arcing, circuit breakers, relays, and florescent lighting. Machinery generates noise from arcing between the brush contacts and the slip rings. Gasoline engines that drive generators, pumps, and other equipment produces ignition noise in the HF and VHF range. Florescent lights generate noise similar to a discharge tube, which couples into and is radiated from the power distribution system onboard the ship. Electrical components, microwave ovens, data processing equipment, and appliances onboard the ship contribute to the EMI noise environment [46].

Transmitters onboard the *Arsenal Ship* contribute to topside EMI for communication equipment throughout the RF spectrum. Transmitters should be designed so that they radiate in as narrow a frequency band as possible. Interference occur due to harmonic frequencies, sideband splatter, intermodulation between signals, cross-modulation between transmitters, parasitic oscillations from antennas, leakage at

waveguide joints, and hull-generated intermodulation due to ground loops. Corrosion produces non-linear effects at grounding points for electronic equipment. Finally, one of the largest contributors to topside EMI is reflected energy which creates multipath effects, constructive and destructive interference, and standing wave patterns [46].

The *Arsenal Ship* topside is arranged such that the weapon system elements and superstructures do not contribute greatly to reflections. Preferring an integrated advanced antenna system to the traditional stacked yardarm, emphasis on geometric angles for radar signature reduction (stealthy) and a lack of yardarms, booms, davits and masts assist in minimizing EMI problems.

The Navy initiated a Shipboard Electromagnetic Compatibility Improvement Program (SEMCIP) to help design ships with electronic systems that are electromagnetically compatible, identify existing fleet EMI problems, and train personnel involved in ship design how to understand EMC problems. Every EMI problem has a source, a coupling, and a victim. Front-door EMI results when the victim receives interference directly from antenna signal. Back-door EMI results when the victim gets it interference internally, such as a power supply or feed line. Intersystem coupling can occur between two different systems and intersystem interference can occur internally within a single system [46].

The Navy convenes an EMC Advisory Board (EMCAB) composed of EMI and EMC experts from Naval Laboratories, universities, and industry to support the *Arsenal Ship* project manager in system design analysis, EMC predictions, test plans, system installation and construction planning. The EMCAB generates an EMI control plan for



routing of cables, waveguides, shielding, grounding, bonding, quality control inspections, and testing to drive EMI out of the *Arsenal Ship* [46]!

**b. Electromagnetic Compatibility below Topside**

The communications systems inside the skin of the *Arsenal Ship* include transmitters, receivers, digital processing equipment, RF distribution networks, and encryption equipment. RF signals are either generated below deck for transmission, sent below deck following reception, or else they represent data used in system operation. The power levels of signal sent out are several magnitudes larger than signals received, which must compete with noise from cosmic sources and man-made machinery. This lopsided balance requires shielding and filtering [40].

Shielding to reduce the electric field strength helps isolate signals and protects victims from unwanted EMI. Shields have to be properly terminated and grounded to prevent leakage. The most effective shield is a complete metal enclosure (i.e., Faraday cage). These need to be open to ventilation for cooling, usually with perforations that are effectively frequency dependent waveguides. Honeycomb shielding is very effective at high frequency and reasonably effective at low frequency [46].

Grounding presents a unique challenge for the combat system and communications engineers. Galvanic corrosions leads to nonlinear interference at grounding bolts and wires (which also need to be shielded). The *Arsenal Ship* hull is the ground reference for all electronic equipment. All grounds should be welded to avoid corrosion and particular attention should be paid to topside connections [46].

Filters protect equipment by limiting the frequency band of signals reaching protected equipment. A typical application of low-pass filters is the use of the control of harmonic

radiation at cable connectors. Both 400 Hz and 60 Hz ship power supply systems can receive interference from one piece of equipment and carry it to another. Filtering at the source reduces EMI [44].

TEMPEST methods isolate encrypted signals from plain ones. Cabling between red and black (i.e., plain and cipher) zones must be entirely separate and equipment racks are different. There is significant efforts to shield and isolate the network that ties the communications systems and combat system nodes onboard the *Arsenal Ship*. EMC engineering is going to be a series of compromises between cost and convenience, performance and practicality. Reasonable levels of EMI can be found and accepted during the eventual construction phase [44].

## **2. Antenna Integration**

Specific problems that the *Arsenal Ship* encounters are blockage (i.e., shadowing) of electromagnetic waves by the superstructure, coupling (i.e., resonant effects) between antenna and superstructure, unwanted RF emission, and hazards of high level radiation. The *Arsenal Ship* has omni-directional receiver antennas such as the HF whip, and directional transmitter and receiver antennas for receiving directional EM waves from satellites. The HF whip antenna length is of the same order of the superstructure length. It is a broadband antenna with couplers for several frequency regions to reduce the number of antennas needed. This lessens the EMI problem. Shipboard receiving HF antennas are usually designed for low efficiency so that the atmospheric noise and the receiver noise generally match [46].

The Navy maintains a test range at the Naval Command and Control and Ocean System Center (NCCOSC) RTD & E Division where measurements are made on 1/48-scale brass model to determine optimal HF antenna placement. The best location for the

VHF/UHF antennas is high on the yardarms for maximum line-of-sight range covering 360 degrees around the *Arsenal Ship*. The trade-off is between antennas and yardarm size (i.e., yardarms increase signature). SATCOM antennas should have hemispherical-coverage. UHF SATCOM transmitter antenna are big, heavy, and often mounted in multiple orders of decreasing coverage. The SHF SATCOM terminal (AN/WSC-6) can be placed high as a single antenna or low as a dual set. Trade-off studies ensure optimal placement [46].

### **3. EMI Control in HF and VHF Systems**

The six categories of EMI sources for HF communications are internally-generated distortions between transmitters, externally-generated nonlinear products, intermodulation due to non-linearities in the receiver, sideband noise generated by transmitters that fall within the receiver's processing band, reciprocal mixing of the receiver local oscillator noise caused by an interfering signal in the receiver bandpass, and front-end gain compression caused by the passband of the receiver [46].

Modern EMI control techniques include the use of nonmetallic topside fixtures whenever possible, antenna separation, narrowband receiver pre-selector filters, self-steering filters, and time division multiplexed transmission [40].

The SINCGARS VHF radio may experience antenna co-site interference due to simultaneous operation of up to four antennas. Most interference sources for VHF radios are the same ones as for HF radios. Some EMI control features include using frequency hopping filters and linear power amplifiers [46].”

The Table IV-34 is an example of anticipated EMI between sources (left) and victims (right) [46]:

	IFF	AIR RAD	SUR RAD	UHF SAT	UHF LOS	HF	VHF LOS	BRG	SAT NAV	OM	SHP AIR
IFF	⊕			⊕							
AIR RAD	⊕		⊕	⊕							
SUR RAD		⊕									
UHF SAT				⊕	⊕				⊕		
HF						⊕					
VHF							⊕				
BRG											⊕
SHP AIR							⊕				

**Figure IV-34. EMI Between Sources and Victims**

#### **4. Topside Design Method**

Once the *Arsenal Ship* TAO modified repeat hull was selected, topside design began. The initial step was to remove all the existing topside structures down to the main deck. This removal included the huge aft deckhouse superstructure and all masts, booms and rigging. What remained was a large smooth main deck with a slightly elevated forward section. The priority for topside design was simplicity and function. The goal was to maintain a low radar cross section (RCS) for topside superstructure, limit ingress/egress points, and reduce topside equipment while providing sufficient superstructure for ship sensors and integration of future sensors discussed in the

communications section. The *Arsenal Ship* topside is divided into five areas; the forecastle gun deck, forward superstructure, missile deck, aft superstructure, and helicopter deck.

With the realization that the selected hull design had an inherently large RCS, the topside design was selected to minimize additional RCS. The removal of dihedral scattering surfaces, two adjacent flat surfaces which meet at nearly perpendicular angles, would eliminate multi-bounce energy reflection paths and reduce large radar cross section (RCS) spikes on the main deck. Shaping of the topside superstructure was used to direct reflected energy to a non-threatening area in space by tilting large surfaces ten degrees. The two superstructures were primarily selected to provide elevated line-of-sight (LOS) and mounting surfaces for ship sensors. The hexagon shape of the superstructures was selected for the addition of a future integrated HF antenna utilizing the six intersection points. Ship ingress and egress points were kept to a minimum for ship protection and monitoring. Located forward and aft on the superstructures, each ship access passes through video/sound monitored double door decontamination points which provide a means of determining identification and automatic containment if desired. To reduce exposure to the elements and to maintain the reduced RCS goal, all non-essential topside equipment was removed or moved inside the ship. The topside of the *Arsenal Ship* is “clean”. With little topside equipment, maintenance associated with equipment exposed to the harsh sea environment is reduced. All essential topside equipment is flush mounted with appropriate covers or is accessible from inside.

The forecastle gun deck is simplified by the exchange of a bow mounted anchor for a keel anchor. The forward windlass was moved below deck for line handling

through removable hull panels. The gun mount space is provided for an advanced 155 mm flush mounted vertical gun. The forward superstructure provides LOS elevation for the bridge, EW equipment mount, flush mounted communications antennas and CEC antenna. Until an integrated hull mounted CEC, the use of a low RCS mast provides the CEC antenna mount. With ship self defense a concern, the top of the forward superstructure was selected as the location for the ship's RAM launcher. This location gave the best area coverage for a bow-on threat sector. With such a large beam RCS, the intent for ship placement in a high threat environment is bow-on. This posture is hypothesized to provide the *Arsenal Ship's* lowest RCS toward the threat and allow the ship self defense system the optimum coverage for response. The missile deck is flush mounted with eight cell armored Mk 41 VLS launchers. The aft superstructure is similar in design to forward. It maintains space available for flush mounted advanced communications antennas and contains the main engine IR exhaust suppresser, satellite antennas, mast mounted CEC antenna. Port and starboard underway replenishment sites are located behind sealed retractable enclosures. The aft helicopter deck provides a platform for aircraft landing only.

## **I. UNDERWAY MISSILE REPLENISHMENT**

Underway replenishment (UNREP) of the *Arsenal Ship's* missile payload is not a requirement in the Ship Capabilities Document [5]. Due to this, the *Arsenal Ship* does not have this capability installed. However, the need to replenish a ship's payload during combat operations is a necessity.

Underway replenishment via connected replenishment (CONREP) is typically an extremely manpower intensive evolution. The manning level required under current doctrine is unacceptable. The primary challenge remaining is how to perform the CONREP of missiles within the framework of the *Arsenal Ship* reduced manning concept.

A method has been developed to not only reduce the number of personnel required for general CONREP, but has also been developed to reduce the number of personnel required to handle missile payloads during UNREP [51]. This design incorporates a rail and trolley system to handle the missiles and a retractable kingpost and storage for the trolley.

The manning requirement for safely conducting UNREP of missiles at sea onboard the *Arsenal Ship* is four: safety observer, trolley driver and two linetenders. This manning level is compatible with the reduced manning concept developed for the *Arsenal Ship*. The other piece of equipment that enables this manning reduction is the winch. The winch is developed to assist the *Arsenal Ship* crew in bringing the UNREP rig over from the replenishment ship, and it reduces the number of linehandlers required for CONREP to three.

The uses for this UNREP system onboard the *Arsenal Ship* are numerous. The most significant of them are the ability to replenish expended ordnance during combat operations, tailor the missile loadout in theater and conduct consol operations between relieving *Arsenal Ships* to maintain valuable missile assets in theater.

With only 512 missiles installed in the *Arsenal Ship*, a limited number of missile mixes may be developed for a specific mission profile. Without UNREP capability for

ammunition, once one type of missile is completely expended, the *Arsenal Ship* is required to leave the area of combat operations to return for missile reload at the forward operating base (FOB). This situation causes the *Arsenal Ship* to be out of theater for a period of up to four weeks plus the time required to perform the missile reload. Tailoring the missile loadout in theater gives the Battle Group (BG) Commander the flexibility to ensure the *Arsenal Ship* has exactly the payload required for its mission.

The *Arsenal Ship* can also be used as a source of replenishment missiles for Aegis cruisers and destroyers. With an *Arsenal Ship* on one side of the replenishment ship and an Aegis on the other, the missiles may be transferred ensuring that the combatant has the missiles required for its mission.

Conducting a consol between relieving *Arsenal Ships* enables the next *Arsenal Ship* the proper loadout required by the BG Commander. This allows the ships to share valuable weapons in our limited missile arsenal. By sharing missiles between two *Arsenal Ships*, the Navy can limit the number of missiles stored at the FOB.

The missile UNREP system is the appropriate equipment to effect missile reload at sea with the *Arsenal Ship*. The estimated cost of installing this system as currently designed is \$6 million. This includes four UNREP stations, two port and two starboard; eight trolleys, one for each 64-cell vertical launching system (VLS) launcher; and the associated storage required for the trolley and other UNREP gear. This is an insignificant cost compared to the potential benefits of having the capability of conducting missile reload and transfer at sea.



## **V. HULL, MECHANICAL, AND ELECTRICAL**

### **A. HULL ALTERNATIVES**

The design philosophy and Concept of Operations (CONOPS) are the driving factors for hull selection. The Arsenal Ship's hull selection is based on overall cost, survivability, manning and the warfighter's needs. This report considers the following hull alternatives:

- Warship
- Small Waterplane Twin Hull (SWATH)
- Catamaran, Trimaran, and Slice
- Specialty Hulls
  - a. Hydrofoils
  - b. Surface Effect Vessels
  - c. Planing Hulls
  - d. Semi-submersible
  - e. Tanker/Cargo Carrier
    - 1. Single Hull
    - 2. Double Hull

#### **1. Warship**

The warship hull-form has an advantage over other hull alternatives in speed and appearance (i.e., it looks like a combatant). It also has a psychological advantage that the other hull-forms do not. A fast hull, however, has only a marginal benefit, because the CONOPS requires a minimum sustained speed of only 22 knots.

This hull-form has many disadvantages that outweigh its benefits. The disadvantages are cost, inefficient volume for a deep 500 vertically launched system

(VLS) load, and poor seakeeping. The warship hull-form was not selected for the *Arsenal Ship* because of these disadvantages.

## **2. Swath, Catamaran, Trimaran, and Slice**

These hull-forms have excellent seakeeping in high sea states. The hull-forms, however, are much more expensive than other alternatives. Additionally, these platforms have never been tested for this type of application. Hence, the overall acquisition costs are also significant. The twin-hulled vessels need a significant amount of freeboard to keep the centrally-located VLS cells out of the water. This high freeboard creates a large and undesirable radar cross-section (RCS). The *Arsenal Ship* design does not use these hull-forms because of these disadvantages.

## **3. Specialty Hulls**

The planing, hydrofoil, and surface effect ship (SES) hulls are considered specialty-hulls. Each hull-form offers unique benefits. These alternatives are expensive and not practical for the *Arsenal Ship* design.

## **4. Semi-Submersible**

The semi-submersible hull offers reduced RCS and excellent seakeeping in the semi-submersed state. The concept behind the semi-submersible is that the platform can submerge itself during combat operations and make itself nearly invisible to surface-search radars. The submersed state also adds excellent seakeeping for missile launch in high states.

A significant disadvantage for the semi-submersible hull-form in this design is the large design and engineering costs. These costs result from the amount of design analysis and testing that must be performed for this nontraditional application. The *Arsenal Ship* design does not use this hull-form because of this disadvantage.

## **5. Tanker/Cargo Carrier**

The tanker/cargo carrier is relatively inexpensive and has a larger volume for the 500 VLS missiles in comparison to the other hull-form alternatives. An additional advantage is that the tanker/cargo carrier hull-form can easily be designed with a double-hull. Furthermore, the hull-form has proven reliability, and most shipyards have extensive experience in its construction. The disadvantages of the hull-form are large RCS and slow speed through the water. Despite these disadvantages, the large-bodied tanker hull-form is selected as the best alternative for the *Arsenal Ship*. The decision is based on the CONOPS requirements for a hull-form with large volume, and relatively slow speed.

The CONOPS requires the *Arsenal Ship* to be virtually unsinkable. Special attention must therefore be paid to minimizing the progressive damage and flooding, maximizing reserve buoyancy, and optimizing compartmentation. These factors can be achieved with a double-hull design. Double-hull design offers a "sacrificial outside layer" that absorbs the energy of a hostile weapon or other platform better than a single-hull design of the same material. The *Arsenal Ship* uses a double-hull design for these reasons.

Cost minimization is important in the *Arsenal Ship* design. A new ship design has significant engineering costs, especially in the case of small production. A cheaper alternative is to use a modified-repeat design. This principle entails selecting a previously designed and built hull and modifying the internal arrangements to satisfy the current requirements. Savings can be further achieved if the alterations to the hull are minimal and the same propulsion plant is used. The *Arsenal Ship* uses a modified-repeat design.

The T-AO 201 class auxiliary ship is a double-hulled ship that lends itself well to this modified-repeat concept for the *Arsenal Ship*. This design can be modified to accommodate 500 VLS cells and allow room for internal attributes that make the ship virtually unsinkable. In addition, the ship-class is primarily built to commercial standards and the Navy already owns the design rights. These two factors provide a considerable cost savings. The delivery cost of the T-AO 201 is \$166 million (1995) [52]. A modified-repeat design, with installed VLS cells and CEC capability, can definitely be built within the \$550 million sailaway cost [5]. For these reasons, the *Arsenal Ship* uses modified-repeat design of the T-AO 201 class auxiliary ship with double-hull.

## **B. PROPULSION PLANT SELECTION**

The principle hull characteristics of the T-AO 201 class auxiliary ship, with a modified-repeat design, remain mostly unchanged. The propulsion system, however, is redesigned to satisfy CONOPS requirements for the *Arsenal Ship*.

The *Arsenal Ship* propulsion system is comprised of two Colt Pielstick 4.2V18 diesel engines. The primary factors in the selection of the diesel engines are available

engineroom volume, reduced manning requirements, reliability, costs, and infrared (IR) signature. Diesel engines can be operated and maintained by Enginemen (EN), who are also responsible for the auxiliary systems. Gas turbine engines are not selected for the *Arsenal Ship* because they require additional qualified gas turbine specialists (i.e., GSE, GSM), and considerable engineroom volume for intakes and exhaust trunks, and support systems and electronics. The nuclear propulsion plant is not selected for the *Arsenal Ship* because it also requires additional qualified nuclear power personnel, considerable engineroom volume, and is extremely expensive. Finally, the fuel cell is not selected for the *Arsenal Ship* primarily because it is still in the developmental stages of design and the costs of engineering testing is expensive.

The *Arsenal Ship*'s Colt Pielstick diesel engines are larger and more powerful than the existing T-AO diesel engines. These larger engines are necessary to provide mechanical propulsion to the ship, as well as, electrical power to the 500 vertically launched system (VLS) cells. This electrical power is taken from the 2500 kW power take-off (PTO) generators that are located aft of the reduction gears. The increase in horsepower is needed to meet the sustained speed requirement of 22 knots. Figure V-1 shows a horsepower versus speed comparison between the *Arsenal Ship* and the T-AO. The *Arsenal Ship* clearly requires a larger amount of horsepower to obtain the higher sustained speed requirement. The *Arsenal Ship*'s diesel engines provide a combined 58,000 shaft horsepower (SHP). The engines provide 46,400 SHP at the sustained speed requirement which exceeds the previous installed T-AO propulsion plant's horsepower of 46,203 SHP at 22 knots.

The *Arsenal Ship* has a mechanical transmission, controllable reversible pitch (CRP) propeller and two shafts. The CRP system is installed to eliminate the need for a reversing gear or reversible diesels in the drive train. The mechanical transmission is installed because it provides a cost savings over electric drive for the modified-repeat design. The *Arsenal Ship* has twin screws as an inherent survivability feature.

### Shaft Horsepower vs Speed

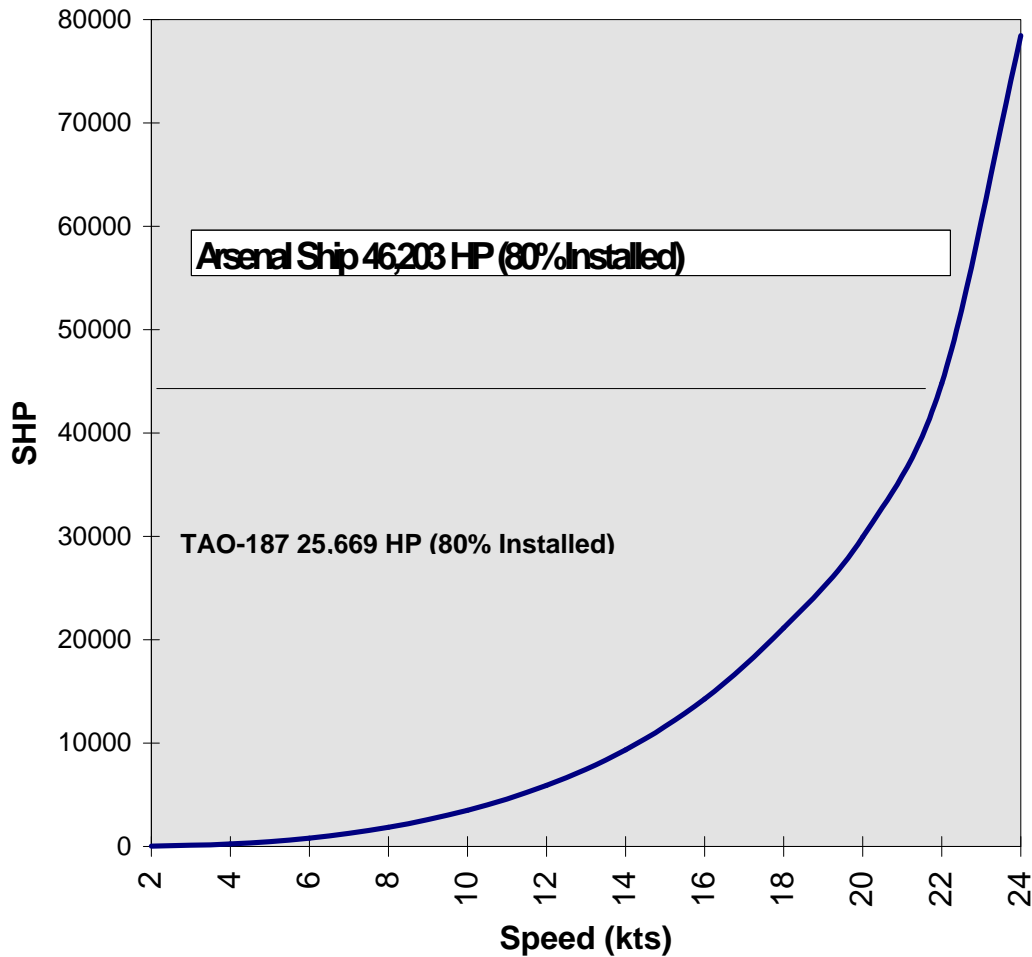
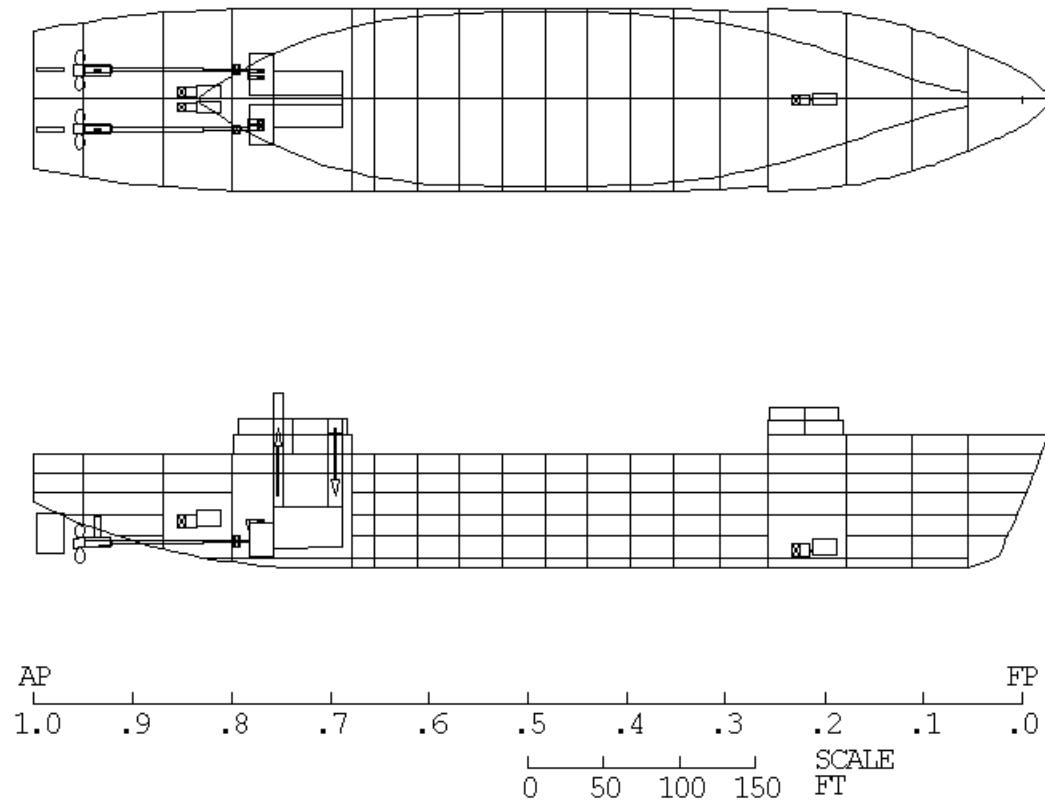
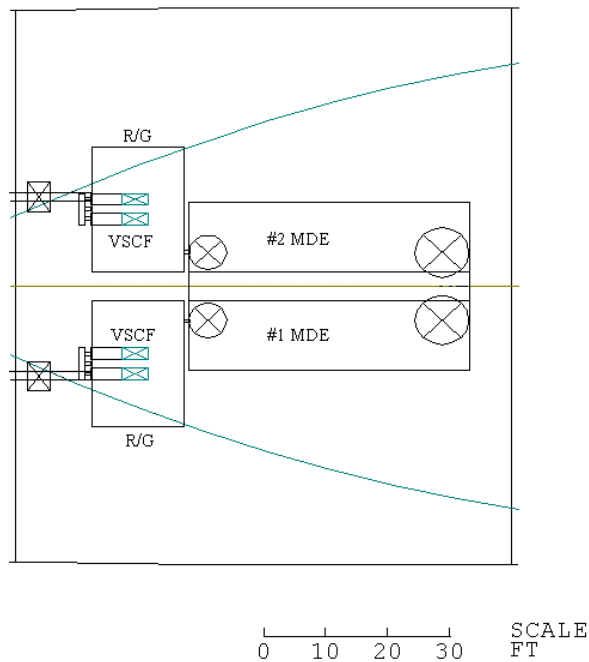

Figure V-1: Shaft Horsepower vs. Speed

### C. PROPULSION PLANT LAYOUT



**Figure V-2: Arsenal Ship Machinery Layout**



**Figure V-3: Arsenal Ship Main Engineeroom**

**MDE: Main Diesel Engines R/G - Reduction Gears VSCF - Variable Speed, Constant Frequency Generator**

**D. ELECTRICAL PLANT SELECTION**

The original electrical plant configuration of the T-AO 201 class auxiliary ship is two take-off generators rated at 2500 kW each, two ship’s service diesel generators (SSDG) rated at 2500 kW each and an emergency diesel generator (EDG) rated at 600 kW. In exploring alternative configurations for the electrical plant, several options were considered, including steam turbine generators, fuel cells and gas turbine generators.

Steam turbine generators require either a nuclear power plant or steam boilers to provide the prime mover. Neither of these options was seriously considered; nuclear



power plants have a significant upfront cost that is beyond the budget of this design and steam boilers are no longer being designed into ships for fuel economy reasons.

Fuel cells take standard DFM fuel and reformulate it to produce hydrogen. It reacts with oxygen in the air to produce electricity directly in the fuel cells. Each cell produces 1 volt and a certain amperage per square foot. The cells are stacked to produce higher voltages. The fuel consumption of the plant is very low, but at the price of very expensive equipment that weighs more than a conventional SSGTG system. This system has possibilities for future implementation onboard ship, but is not developed enough to be ready for installation in the *Arsenal Ship*.

Gas turbine generators offer distinct advantages over diesel generators. These include a much higher power-to-weight ratio, a much higher power density and shorter time from start-up to full power. In designing the modified-repeat of the T-AO 201, these issues were of lesser importance. The mission profile of the *Arsenal Ship* does not indicate a need for rapid deployment from port and there is little need for the advantage of greater power density as the sustained speed requirement is only 22 knots. The two most significant reasons for not selecting gas turbine generators are the large intake and uptake volumes required and the high exhaust temperature, significantly increasing the *Arsenal Ship*'s IR signature.

For the reasons outlined above, the electrical plant configuration of the *Arsenal Ship* is of a similar design to the original T-AO 201. The modifications that were made to the plant are to upgrade the EDG to a full 2500 kW SSDG and to design in a zonal electrical distribution system with three buses to provide sufficient redundancy to provide ship's power for the *Arsenal Ship*'s vital payload. The additional 2500 kW SSDG is

installed below the forward living spaces to provide increased survivability of the electrical plant. The four other generators, two take-off and two SSDGs, are installed aft in the machinery spaces.

The *Arsenal Ship*'s electrical distribution system is an AC zonal distribution (Figure V-4). There are 15 electrical zones, eight of which are in the VLS section of the ship with 64 VLS cells each. Zonal electrical distribution provides complete interconnectivity of the generators, switchboards and load equipment. The immediate advantage in construction is the weight reduction of the cabling since significantly less cabling is required to implement three buses than to implement the spider web of electrical cabling that is prevalent on today's Naval ships. Three buses provide easier isolation of spaces and rerouting of power in the event of damage. Each electrical zone incorporates three load centers, providing primary, secondary and tertiary sources of power for all vital loads within the zone. Non-vital loads will be supplied from the nearest load center, reducing the cable length required.

**Figure V-4: Electrical Distribution System: 3 Primary Busses, 15 Zones**

**E. EXTERNAL SHIP VIEWS**

**Figure V-5: Plan View**

**Figure V-6: Forward Port Bow View**

**Figure V-7: Forward Stbd Bow View**

**Figure V-8: Aft Port Qtr View**

**Figure V-9: Aft Starboard Qtr View**

**Figure V-10: Bow View**



**Figure V-11: Stern View**

## **VI. ARRANGEMENTS**

### **A. INTERNAL ARRANGEMENTS**

#### **1. Deck Level Plans**

The internal arrangement of spaces for the *Arsenal Ship* is based on the following list of priorities:

- Survivability
- Reduction in radar cross section by hiding topside equipment inside the hull
- Physical Security
- Habitability

#### **a. Forward Internal Arrangements**

##### **(1) Superstructure**

The goals for the design of the forward superstructure are to:

- Provide the Officer of the Deck (OOD) all of the necessary elements to totally command the ship from the bridge
- Optimize the field of vision for the OOD
- Provide spaces for forward combat system equipment and maintenance
- Minimize radar cross section

The superstructure is designed to reduce the amount of topside equipment by eliminating the construction of bridge wings. Windows completely surround the forward superstructure except in the extreme port and starboard sides that contain the SLQ-32s. A passageway is built into the forward superstructure to give bridge watchstanders a 360 degree view of the horizon, while still keeping them within the skin of the ship.

Additional spaces have been provided in the superstructure for SLQ-32 and AEWIS equipment and maintenance. Space is also provided for a Captain's at-sea cabin and a chartroom.

## (2) Habitability

The goal for the design of the habitability spaces is to locate all of the crew berthing and messing facilities in the forward section of the ship. This minimizes the need for the crew to transit the entire length of the ship during peacetime operations. NOTE: Additional berthing for officers, chief petty officers (CPOs), and enlisted personnel is provided in the aft section of the ship for combat operations. This enhances survivability by separating personnel living quarters. In addition, this provides additional overflow berths for temporary duty personnel.

Officer's country is located on the main deck. Twelve staterooms are located on this deck to accommodate the estimated ship's complement of officers. Space is also provided on this deck for the Captain's inport cabin and a Flag cabin.

The CPOs' quarters are located on the second deck. Six berthing spaces are located on this deck to accommodate the estimated ship's complement of CPOs.

The enlisted berthing spaces are located on the fourth deck. Four berthing spaces are located on this deck to accommodate the estimated ship's complement of enlisted personnel. The ship's laundry is also located on this deck.

The galley, messdecks, chief's mess, and wardroom are located on the second deck. This deck is also the damage control deck. These spaces are all located within close proximity of one another to facilitate the use of only one galley area for all food

preparation and serving. The location of these facilities on the second deck provides the crew a direct access to the aft section of the ship along the port and starboard longitudinal passageways. This is especially important for the onload of food and offload of trash from these spaces. The food storerooms and reefers are also located on this deck to minimize the distance between the galley and these frequently used spaces.

### (3) Gun

Space has been provided in the forward section of the ship to accommodate a future gun system. This space is three decks deep. Due to safety considerations, the spaces directly below the gun have been designated as voids, which can also accommodate a substantial structural reinforcement.

### (4) Anchor

The *Arsenal Ship* has a keel anchor to reduce topside equipment and the number of personnel needed for anchoring evolutions. The anchor windlass is located on the main deck, directly above the chain locker. By keeping this equipment within the skin of the ship, the radar cross section is once again reduced from that of a standard naval combatant.

### (5) Combat Center

The combat, communications, and computer centers are located in an armored enclave on the third deck. This armored enclave technology is similar to that of the Arleigh Burke Class destroyer. The location was chosen to provide survivability from topside missile damage, while keeping it above the waterline to limit damage due to

underwater threats and flooding. A remote Standard Monitoring Control Station is located in this well protected space.

#### (6) Combat Support Spaces

Space is provided in the forward section of the ship for electronic support spaces. Currently these spaces include: Forward IC/Gyro Room; Electronics Repair Eight; Electronics Cooling Equipment Room; and a Data Processing Systems room. The 400 Hz electrical distribution spaces are located on the main deck starboard side and the third deck port side. The separation of these spaces is to enhance their effectiveness should one become damaged in a casualty.

#### (7) Engineering Spaces

The fifth deck of the forward section contains auxiliary engineering spaces. These spaces include: CHT room; Reverse Osmosis Room; Auxiliary Generator Room; Forward A/C room; and two Forward Pumprooms. The pumprooms contain space for firepumps and miscellaneous equipment. These spaces are designed to provide primary engineering services to the habitability area. In addition, the separation of these spaces from their aft counterparts provides sufficient distance for maximizing survivability in the event of damage.

#### (8) Physical Security

The *Arsenal Ship* is designed with limited access to the internal spaces. The forward section of the ship has two accesses located transversely and aft of the main deck. The starboard access enters into the forward decontamination station. The port access is

located in close vicinity to the forward armory. This provides the security force a primary exit to combat any hostile boardings. Both accesses also provide for an overpressurization zone.

#### (9) Damage Control

The forward repair locker and AFFF station are located on the starboard side of the second deck (damage control deck). This location is chosen due to its close location to the port and starboard longitudinal passageways. Should these lockers be needed for damage control in the after engineering spaces, the crew, who are assumed to be concentrated in the forward section of the ship, can rapidly don equipment and then transverse down these passageways to the after section of the ship. In addition, the repair locker is placed adjacent to the messdecks to provide a staging area for personnel and equipment.

#### (10) Small Boat

The rigid inflatable boat (RHIB) is stowed in a shielded space on the port side of the main deck. The boat is deployed and recovered by a hydraulic extendable arm, 360 degree azimuthing crane. Both the crane and the RHIB are hidden within the skin of the ship for purposes of reducing radar cross section. Access to this space is gained by opening a watertight enclosure mechanism.

**Figure VI-1: Forward Superstructure**

**Figure VI-2: Main Deck Forward**

**Figure VI-3: Second Deck Forward**



**Figure VI-4: Third Deck Forward**

**Figure VI-5: Fourth Deck Forward**

**Figure VI-6: Fifth Deck Forward**

**Figure VI-7: Sixth Deck Forward**

## **b. Aft Internal Arrangements**

### **(1) Physical Security**

The after section of the ship also has two accesses to internal spaces of the ship. The port side access enters the aft decontamination station. The starboard access enters the quarterdeck area and is in close proximity to the after armory. Both accesses provide for an overpressurization zone.

### **(2) Refueling Stations**

The *Arsenal Ship*'s refueling stations are located in the after superstructure. The stations are shielded by two weathertight doors that separate at the port and starboard corners. A winch and padeye are located at each station to provide for refueling at sea capability. The stations are located within weathertight enclosures to minimize radar cross section and system degradation due to the environment (ie. Less maintenance) and for safety purposes.

### **(3) VERTREP Stations**

The after superstructure also provides a staging area for VERTREP operations. The firefighting team are protected inside a firefighting staging area located next to the port access. Additionally located next to this access is the entrance to the VERTREP pallet staging area. This space provides a large area for the rapid and efficient clearance of the flight deck during VERTREP operations. A strikedown elevator is located in this space, and it connects the staging area to the supply storeroom, engineering machinery spaces, and the two passageways leading to the forward section of the ship. The elevator

is designed to enable the minimally manned crew a system that they can use to strikedown/remove small equipment or stores directly from the replenishment area. A VERTREP control station is located on the second level of the aft superstructure to enable the VERTREP/Helicopter Control Officer a safe lookout location to supervise the helicopter evolutions.

#### (4) Battle Berthing Spaces

Additional berthing spaces are located in the aft section of the ship to segregate the crew during combat operations. These spaces accommodate 24 enlisted personnel, 4 CPOs, and 5 officers.

#### (5) Damage Control

The aft repair locker and AFFF station are located on the damage control deck. Also on this deck is the sickbay facilities. Sickbay is located centerline to provide a stable ride for medical emergency procedures.

#### (6) Engineering Spaces

The main machinery spaces, after steering, and aft A/C machinery spaces are all located in the aft section of the ship. The engineering control station is located on the damage control deck. The aft section also contains a large void directly above the engineering spaces to accommodate a soft patch for engine removal.

#### (7) Combat Support Spaces

Space has been saved in the after superstructure for future electronic rooms that may serve additional communications systems and/or a phased array radar system.

Additionally, the aft IC/Gyro room is located on the third deck, which provides separation and redundancy for increased survivability.

#### (8) Crew Support Spaces

A large recreation room and physical fitness room is located in the aft section of the ship. The need for these spaces forward was not considered a priority. Sufficient space is available in the after section of the ship to accommodate these facilities.

**Figure VI-8: Main Deck Aft**

**Figure VI-9: Second Deck Aft**

**Figure VI-10: Third Deck Aft**

**Figure VI-11: Fourth Deck Aft**

## B. DETAILED ARRANGEMENTS

### 1. Bridge Layout Drawings

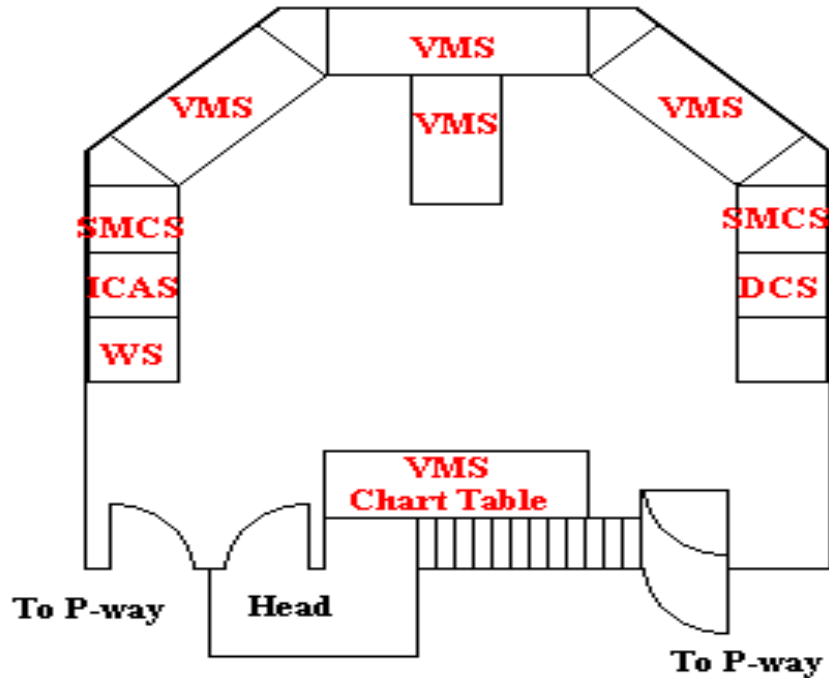

## **Integrated Bridge System Layout**

**VMS - Voyage Management System**

**DCS - Damage Control System**

**SMCS - Standard Monitoring and Control System**

**ICAS - Integrated Condition Assessment System**

**WS - Computer Work Station**

Figure VI--12: Integrated Bridge System Layout



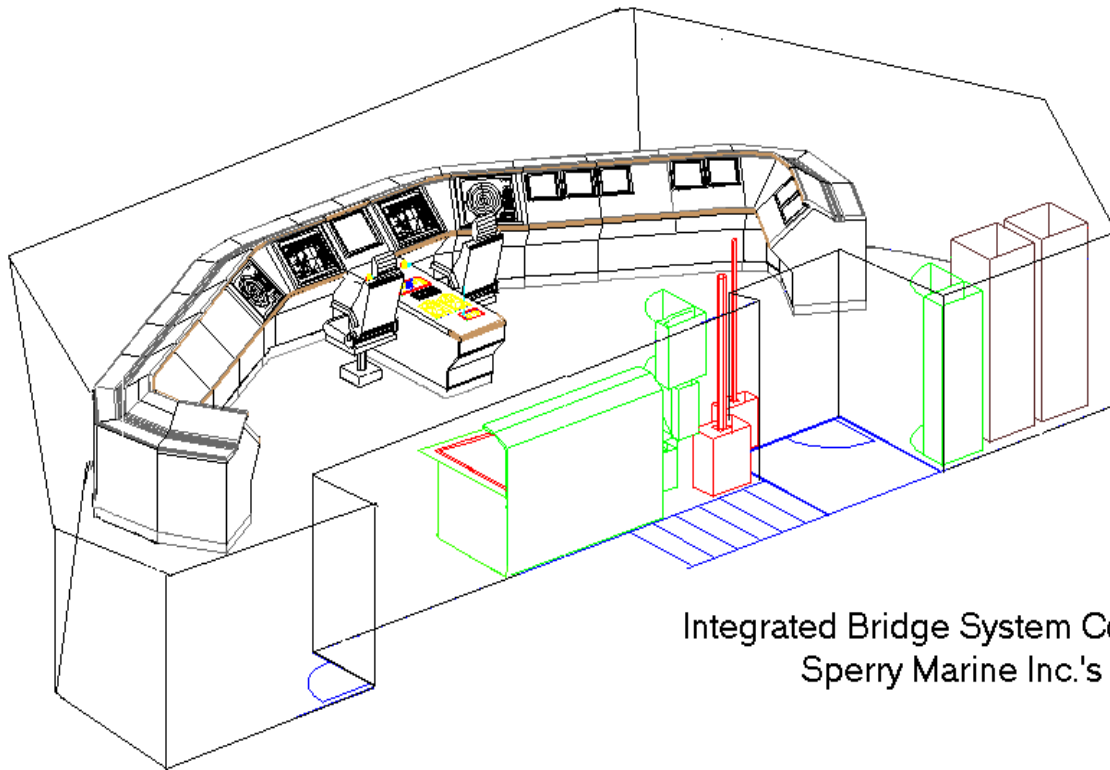

Integrated Bridge System Concept  
Sperry Marine Inc.'s

**Figure VI-13: Integrated Bridge System**

2. Engineering Central Control Station Drawings

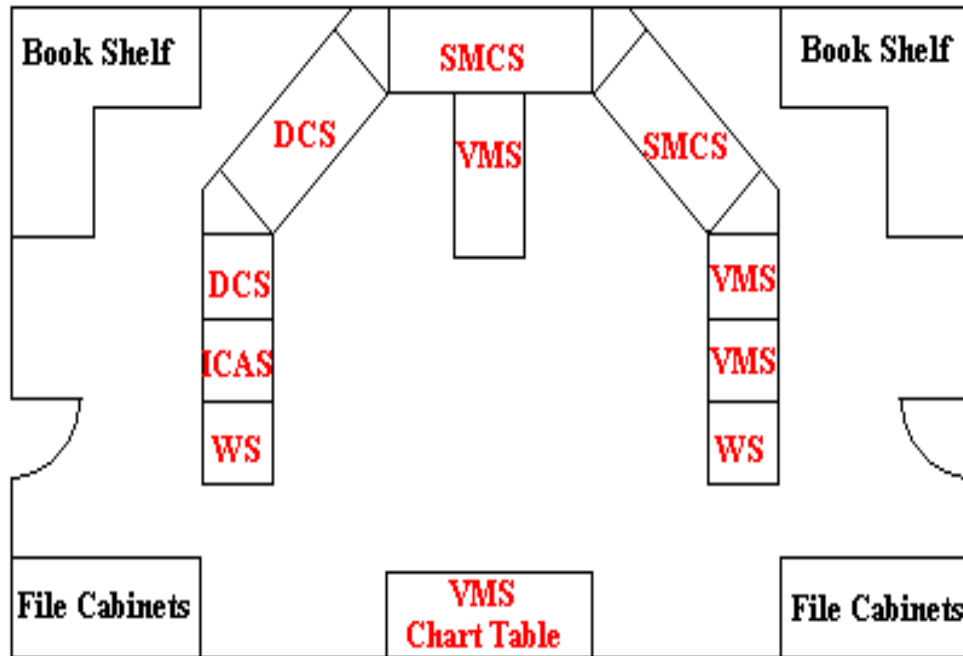

**Engineering Control Center - Aft Console**

**VMS - Voyage Management System**

**DCS - Damage Control System**

**SMCS - Standard Monitoring and Control System**

**ICAS - Integrated Condition Assessment System**

**WS - Computer Work Station**

**Figure VI-14: Engineering Central Control Station Drawings**

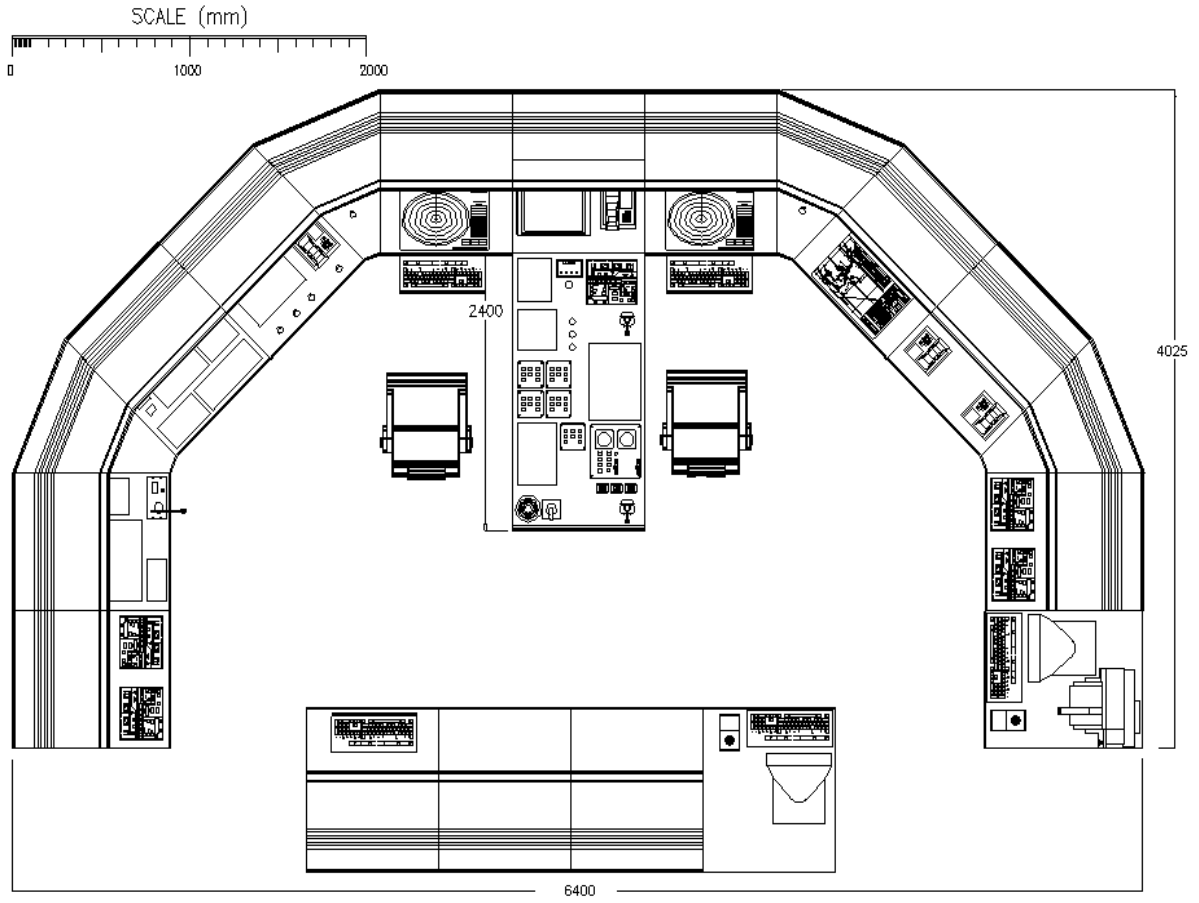

**Figure VI-15: Engineering Central Control Station**

### 3. Combat Information Center Drawings

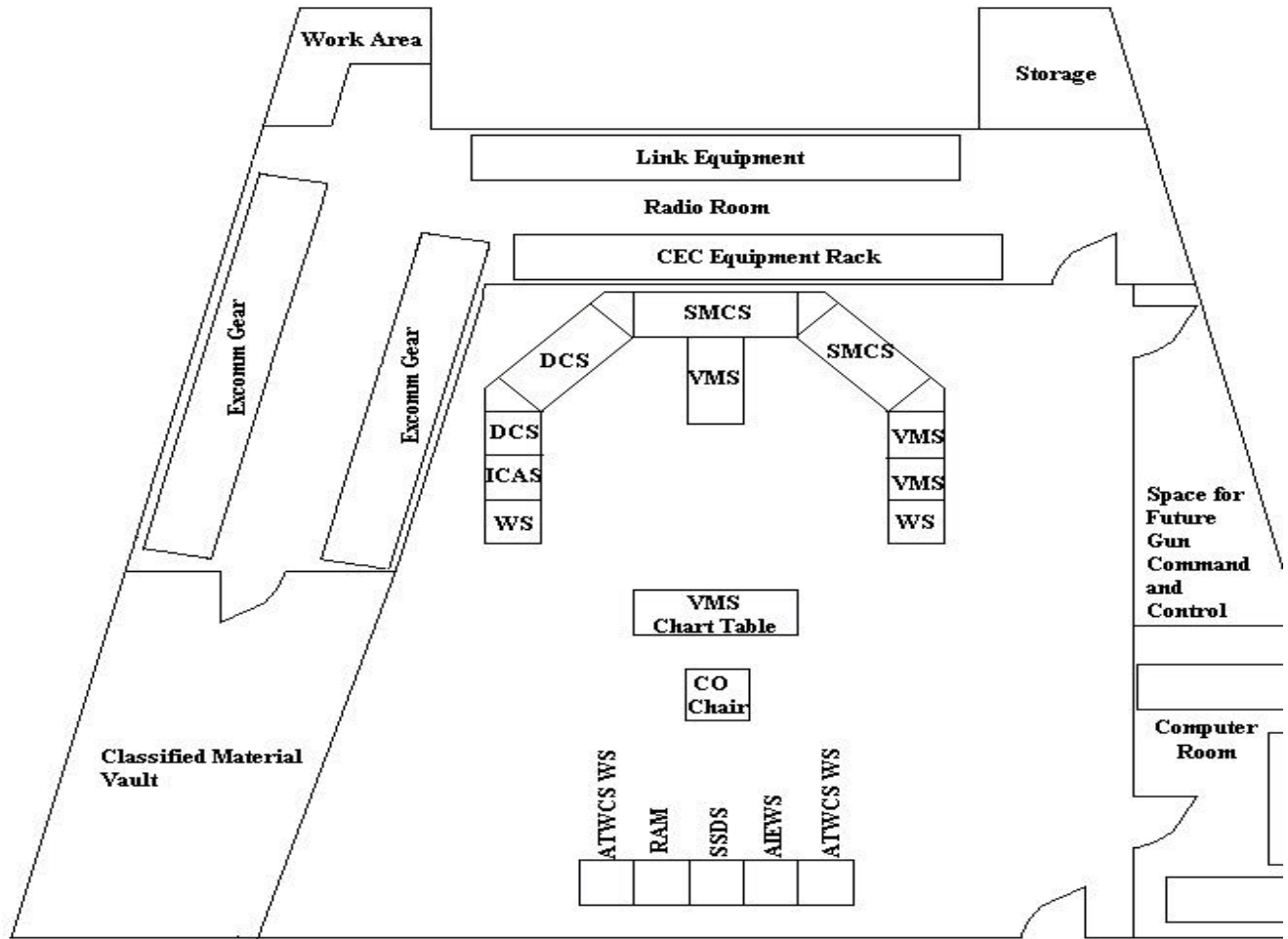

**Figure VI-16: Combat Information Center**

#### **Combat System Control Consoles:**

ATWCS WS-Advanced Tactical Weapons Control System Work Station  
RAM-Rolling Airframe Missile Console  
SSDS-Ship's Self Defense System Console  
AIEWS-Advanced Integrated Electronic Warfare System Console

#### **Integrated Bridge Control Consoles:**

VMS-Voyage Management System  
DCS-Damage Control System  
SMCS-Standard Monitoring and Control System  
ICAS-Integrated Condition Assessment System  
WS- Computer Work Station

## VII. SURVIVABILITY

### A. INTRODUCTION

The *Arsenal Ship* is an extremely high value unit and undoubtedly faces the most powerful and sophisticated anti-surface weaponry our enemies have to offer. The sinking or incapacitation of an *Arsenal Ship* carrying hundreds of missiles, not only serves as a terrible tactical blow to U.S. forces, but also fuels our enemies with hope. It is therefore paramount that this ship is designed with a high level of survivability.

Survivability is defined as the "capability to avoid and/or withstand a man-made hostile environment. [6]" Survivability is divided into two categories:

- Susceptibility - the inability to avoid being hit
- Vulnerability - the inability to withstand a hit

The *Arsenal Ship* is designed to sufficiently decrease susceptibility and vulnerability, thereby increasing the overall survivability of the ship.

### B. APPROACH

Because it is a high value asset, the *Arsenal Ship* is designed with Level III protection [53]. Level III protection means that the *Arsenal Ship* is placed in the same protection category as aircraft carriers and battle force surface combatants, operating in the most severe warfare environments.

A series of survivability comparisons between the T-AO and the *Arsenal Ship* were conducted using a trade-off analysis program [54]. Attributes such as percent of radar cross-section (RCS) reduction, number of escorts, relative amount of topside hardening

and self defense features (i.e., RAM, CIWS, SM-2, etc.) were varied for each run. The algorithm was based on all of the past warship casualties that resulted from missile hits (i.e., Falkland War, Arab-Israeli War). The program confirmed the concept that a balanced approach to protecting the ship was the most survivable alternative.

The *Arsenal Ship* incorporates a reasonable amount of signature reduction, hardening, redundancy, separation, active damage control and self defense systems. Exhaustive efforts in stealth technology, and hardening from missile and torpedo damage, are not in the *Arsenal Ship* design due to excessive costs. The *Arsenal Ship* survivability features are designed to reduce the risk of damage caused by air, surface, and sub-surface forces. Automation is added into the survivability features to increase response time and decrease manning levels.

### **C. SUSCEPTIBILITY**

The initial step in thinking about survivability is to prevent being hit. Therefore, it is believed that sufficient effort should be placed in providing *Arsenal Ship* with designs and systems which reduce susceptibility.

The *Arsenal Ship* is designed with an increase in passive self-defense systems and minimal active self-defense systems[5]. Since the *Arsenal Ship* has no active self-defense capability, it always operates under the protective umbrella of an AEGIS escort ship.

Due to the possible saturation of the escort's anti-air active self-defense umbrella, the possibility of an incoming anti-ship missile leaking past these defenses is high. Applying sufficient stealth technology to prevent targeting from an anti-ship missile is impractical due to the *Arsenal Ship's* large size. Consequently, the *Arsenal Ship* is

designed with sufficient mass tonnage to absorb anti-ship missile explosions. A Rolling Airframe Missile (RAM) launcher is designed to provide the *Arsenal Ship* a limited active self-defense capability.

#### **D. VULNERABILITY**

A key design feature for the *Arsenal Ship* is that one shot does not keep the ship from performing its mission. It is designed for rapid damage localization and minimization. The minimization and localization of damage is enhanced by improvements in redundancy, separation of common systems, hull design, damage control, and hardening.

##### **1. Redundancy and Separation**

The most significant implementation of redundancy and separation on *Arsenal Ship* is the use of sixty-four individually armored 8-cell vertical launching system (VLS) launchers [55]. This design feature reduces the effects of a single mass detonation of a large 64-cell VLS launcher, by replacing it with smaller 8-cell launchers with armored separation. Each of the eight-cell launchers has an independent power source and is protected by a reinforced bulkhead on all four sides. Furthermore, these launchers are transversely arranged in rows of four with the two outboard, most vulnerable, cells separated from the inboard two by 11.5 feet. This 11.5 feet separation includes five inches of steel provided by the two interior bulkheads.

In addition to the separation of the VLS launchers, *Arsenal Ship* has several other redundant and/or separated systems. The remote-launch capability employs a Cooperative Engagement Capability (CEC) antenna on the forward mast as the primary system, and

Link-16 and Link-22 antennas on the aft mast as the secondary and tertiary systems. The electrical system has five equally-rated ship service generators located in three separate compartments. Each generator can power the entire ship via any one of the three separate power distribution busses. Each bus feeds the ship's 15 electrical zones, which are completely isolated from one another. This architecture allows *Arsenal Ship* to withstand damage in one zone without degrading the power to the others. The firemain system is also designed using zonal architecture. Eight fire pumps feed into a firemain loop which provides firefighting to eight firemain zones.

The *Arsenal Ship* is designed with a single engineroom due to cost constraints and reduced manning levels. The impact of this on the *Arsenal Ship*'s mission is minimal since the ship is less dependent on propulsion than on electrical power for VLS and CEC. The ship is designed with twin screws that provides additional survivability to the ship's ability to maneuver.

## **2. Passive Damage Suppression**

The *Arsenal Ship* uses increased structural strength, armor, watertight compartmentation and reserve buoyancy to limit damage to manageable levels for the automated systems and shipboard personnel.

The *Arsenal Ship* has sufficient reserve buoyancy to take on large amounts of water and remain afloat. It is highly compartmentalized with seventeen transverse watertight bulkheads and three longitudinal watertight bulkheads. The three compartment floodable length standard is a conservative estimate due to its double-hull design, added longitudinal bulkheads and permeability reduction features. One such feature is the foam-in salvage



system[62]. This system “foams” a flooding compartment, thus decreasing permeability and restoring reserve buoyancy. The foam is used only in extreme emergency situations, because the solidified foam renders the space untenable.

The *Arsenal Ship* does not have any access penetrations through watertight bulkheads, below the damage control deck. Watertight closures are hydraulically-activated. The hydraulically-activated doors and hatches are remotely-triggered, and have a “fail to close” default. This system ensures complete material conditions are set.

In addition to maintaining the watertight integrity of the ship, damage due to missile attacks is reduced by side-impact structures. These structures, located between the inner- and outer-hulls, extend from the main deck to five feet below the waterline, and run the entire length of the VLS section of the ship. They are constructed of four layers of six-inch thick concrete and six-inch thick honeycomb polymer material. This system is designed to distribute the impact of the missile over the effected panel and dissipate the kinetic energy of the missile by redirecting the energy in directions away from the launchers.

### **3. Component Location and Shielding**

The missiles are protected on all sides by 2.5-inch thick armor-plating. The armor provides additional resistance to missile impact and contains the exploding ordnance within the launcher. This, coupled with separation between launchers, aids in preventing mass detonation of all missiles onboard. The 2.5-inch steel thickness is limited by the maximum thickness that can currently be welded with a single-pass electrosag weld.

The command and control spaces are located deep within the ship. Crew habitability spaces are dispersed fore and aft. This dispersion avoids the potential of losing a majority of the crew to a single missile hit. Half of the VLS cells are located near the centerline, providing them with added protection. Additionally, the electrical distribution busses are arranged to provide maximum survivability. The port and starboard busses are located high near the main deck, while the centerline bus is located near the keel. All three busses are shielded by a steel enclosure to reduce the likelihood of damage.

#### **E. DAMAGE CONTROL**

The *Arsenal Ship's* Damage Control System (DCS), Standard Machinery Control System (SMCS) and Integrated Condition Assessment System (ICAS) responds automatically to any damage control situation. The ship uses remote-sensors to detect fire, flooding, access to spaces, toxic gasses, and monitor equipment. This information is sent to the DCS for evaluation. SMCS monitors and controls all machinery systems. ICAS monitors the major machinery for maintenance problems that effects plant operation, and interacts with SMCS for control procedures on machinery casualties.

DCS require no full-time manning. It has two modes of operation. The first is the fully-automated mode, and the primary mode used. The second is the prompting-mode. In this mode, the system suggests the proper response and awaits for directions from the console operator. These automated systems control propulsion, electrical distribution, ventilation, drainage, firemain and sprinklers, CO<sub>2</sub> flooding, AFFF, material condition, cooling water, fuel and oil systems.

Hydraulically-activated watertight closures are automatically programmed to close in the event of damage. The closure signal is sent to the doors from DCS, upon detection of a casualty in the effected zone. Ventilation fittings are isolated with electrically-operated valves. SMCS reroutes vital services around the damaged area, and places additional equipment online, as needed. The electrical distribution panels in the zones are secured as required. Two separate distribution panels, 110 volts and 440 volts, are used to allow lighting to be left energized, while electrical power is secured in the effected area.

All spaces are fitted with an overhead sprinkler system. The sprinkler system is activated when a fire is sensed in the space. High velocity fog, carbon dioxide (CO<sub>2</sub>), or aqueous film-forming foam (AFFF) are selected based upon equipment in the space and degree of protection required. The installed drainage system is then activated by the sewage vacuum system or bilge drainage system, to remove accumulated firefighting water.

Flooding situations are handled along the same lines as fire casualties. The additional foam-in-salvage system is used in extreme casualties, since the space is left untenable after activation. The foam is sprayed in through an installed sprinkler system to restore lost buoyancy.

Three variations are used to control space ventilation. First, positive ventilation is set in adjacent spaces near the damaged area. Second, negative ventilation is set in the damaged compartment. Finally, ventilation fittings are secured in the space.

## **F. CHEMICAL, BIOLOGICAL AND RADIOLOGICAL (CBR)**

The entire ship is protected by a Collective Protection System (CPS). All ventilation intakes are routed through filter rooms to remove contaminants before they can enter the ship. The ventilation systems pressurize the interior of the ship to two inches of water, to provide a positive seal. The four weatherdeck accesses have hydraulically-actuated watertight doors, that are remotely or automatically opened or closed. A decontamination station is located on the starboard side of the fore and aft weatherdeck access.

The external skin of the ship is protected by a water washdown system. This system prevents airborne contaminants from adhering to the ship. The *Arsenal Ship* is designed to reduce the accumulation of topside contaminants by minimizing the amount of topside equipment. Calcium hypochloride can be injected directly into the water washdown system. This cleaning solution is sprayed onto the deck in the event of a biological or chemical threat, thus eliminating the need for personnel exposure to the agents.

## VIII. NAVAL ARCHITECTURE

The *Arsenal Ship* naval architecture design is tailored to an existing computer model of the T-AO 201 class auxiliary ship. Advanced Surface Ship Evaluation Tool's (ASSET) MONOLA is used to model monohull landing and amphibious ships. Although *Arsenal Ship* is neither of these, the basic hull form is more similar to them than it is to the traditional surface combatant. Using the T-AO as baseline, the *Arsenal Ship* model does not include the weights and volumes associated with cargo (fuel, water, stores, etc.), cargo pumps and underway replenishment equipment. The weights, volumes and center of gravity locations are added to the model for equipment and systems peculiar to *Arsenal Ship*, (i.e., VLS launchers, concrete side impact system and the future gun system). A complete list of these additions is located in the Payload and Adjustments report of Appendix C. Most of the other weight groups, identified by three-digit Ship Worklist Breakdown Structure (SWBS) numbers, also require adjustments from the original model. Some of these adjustments are scaled from the T-AO using built-in parametric equations. Others variables are calculated by ASSET, or require user input. ASSET performs detailed analyses (i.e., floodable length, resistance, power requirements, endurance, longitudinal strength, etc.), after the weight and space allocations are entered

### A. HULL GEOMETRY

Since *Arsenal Ship* is a modified-repeat design, some of the traditional naval architecture are fixed. The hull geometry for the *Arsenal Ship*, specifically hull offsets,

enclosed volume and appendages, are identical to the T-AO. Below is a summary of the important hull characteristics of the *Arsenal Ship*.

Principal Characteristics



The body plan of the *Arsenal Ship*, shown in Figure VIII-1, gives an excellent perspective of the high (0.98) midship section coefficient.

S

**Figure VIII-1: *Arsenal Ship* Body Plan**

## B. HYDROSTATIC CURVES

The *Arsenal Ship*'s hydrostatic curves, or curves of form, are identical to the T-AO. These curves, shown in Figure VIII-2, show how the *Arsenal Ship* responds to various static conditions, dependent on mean draft. The individual curves are::

- A. Displacement (5000 LT/division)
- B. Moment to Trim 1-inch, MT1" (500 ft-LT/inch per division)
- C. Tons per Inch Immersion (TPI) (20 LT/inch per division)
- D. Transverse Metacentric Radius,  $BM_T$  (5 ft per division)
- E. Longitudinal Metacentric Radius,  $BM_L$  (100 ft per division)
- F. Vertical Center of Buoyancy, KB (2 ft per division)
- G. Change in Displacement per unit trim by stern (10 LT/ft per division)
- H. Wetted Surface Area (10000 sq ft per division)
- I. Longitudinal Center of Buoyancy (5 ft per division)
- J. Longitudinal Center of Flotation (5 ft per division)

**Arsenal Ship  
Hydrostatic Curves**

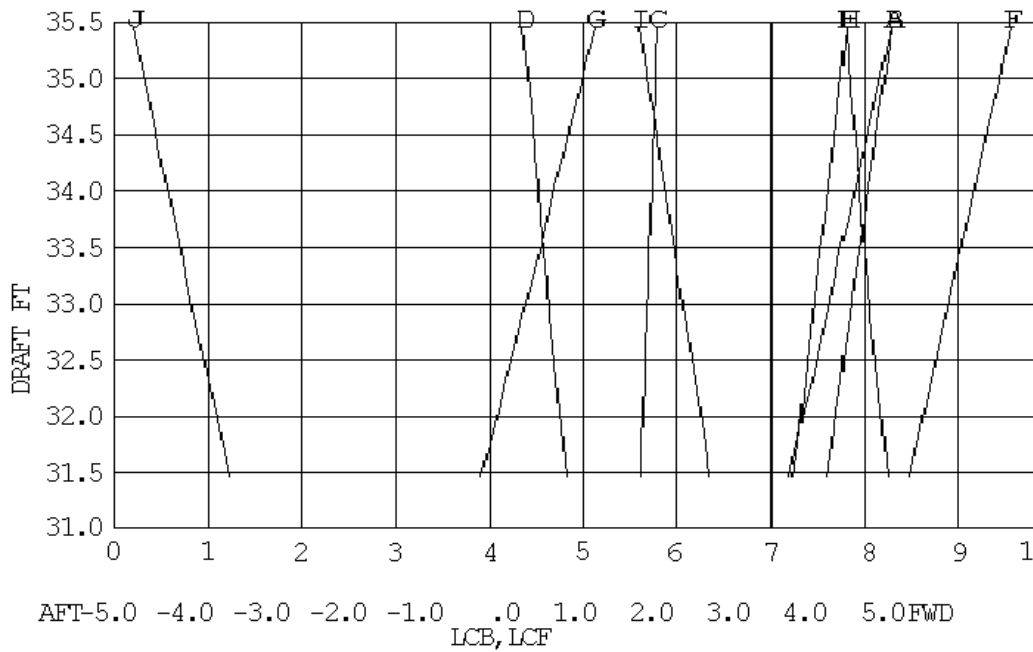
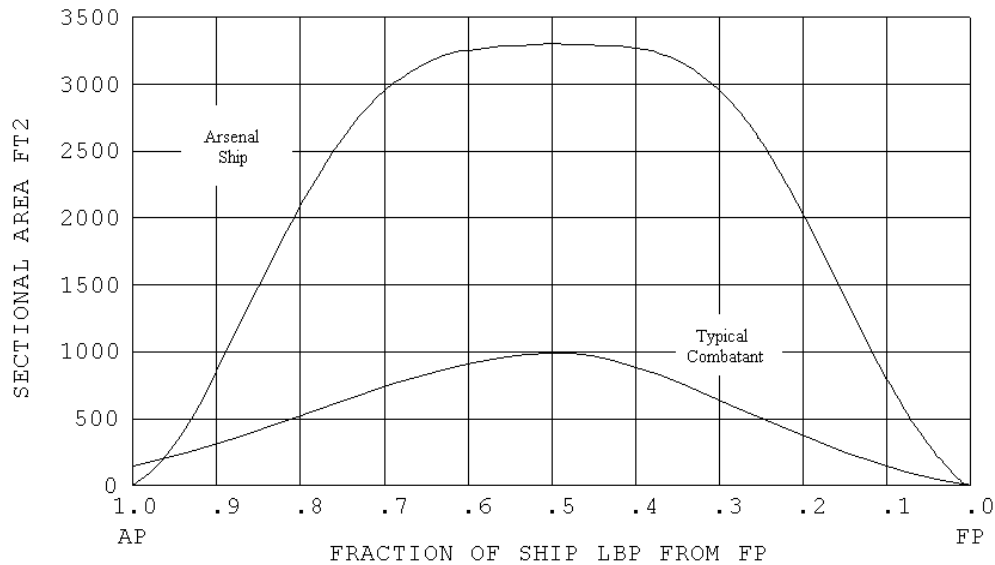

**Figure VIII-2: Hydrostatic Curves**

**C. SECTIONAL AREA CURVE**

The sectional area curve shown in Figure VIII-3 illustrates the extremely large sectional areas in the midsection of the ship. The flattened portion at the top of the curve is of particular importance. This large, nearly parallel, midbody allows maximum flexibility in the VLS arrangement, and thus optimizes survivability.





**Figure VIII-3: Sectional Area Curve**

#### **D. HULL SUBDIVISIONS AND FLOODABLE LENGTH**

*Arsenal Ship* has seventeen transverse watertight bulkheads to maintain reserve buoyancy in the event of flooding. Bulkhead locations are first determined by using the existing engine room and auxiliary machinery bulkheads. Next, transverse bulkheads are placed between every two rows of VLS cells. And finally, the remaining bulkheads are placed such that the three compartment floodable length standard is achieved. This is a conservative estimate of *Arsenal Ship*'s ability to withstand flooding however, because it does not include several important factors. First, *Arsenal Ship* is designed with a double-hull with six feet of spacing between the two hulls. The entire midbody of the ship has longitudinal watertight bulkheads to prevent the spread of damage transversely. These two features reduce the likelihood of flooding the entire volume between transverse bulkheads

to the waterline. Second, the three compartment floodable length is based on using the standard permeability factors recommended in Principles of Naval Architecture [56].

These permeability factors are as follows:

- Habitability Spaces: 0.95
- Machinery Spaces: 0.85
- Cargo/Storage Spaces: 0.60

These permeability factors are applied to the entire section of the ship, as is typically done. Features, such as the side impact system contained in the double-hull, raises the *Arsenal Ship*'s permeability and improves floodable length. Further iterations can implement a closer, yet more complex, approximation of these permeability factors. This can account for such spaces as the forward auxiliary machinery room ( $\mu=0.85$ ) that is actually located in a subdivision that is otherwise habitable ( $\mu=0.95$ ) on the T-AO. Finally, the existence of a foam-in-salvage system has the potential to drastically reduce the permeability of a compartment and thus restore reserve buoyancy. For these reasons, it is reasonable to predict that *Arsenal Ship*'s floodable length is greater than three (Figure VIII-4).

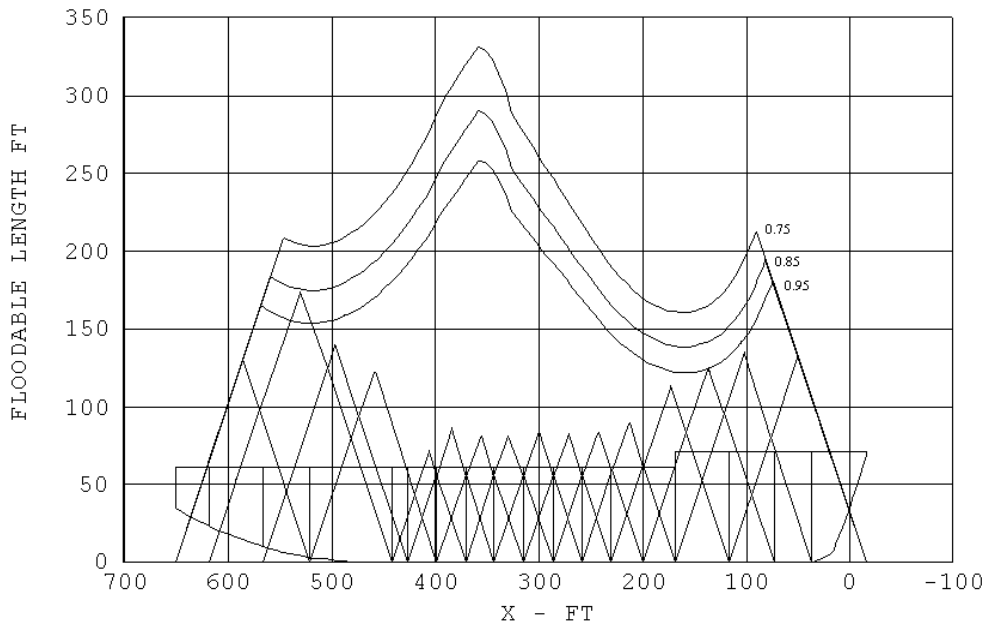

**Figure VIII-4: Arsenal Ship's Floodable Length Curves**

#### **E. STATIC STABILITY**

Static stability is the measure of whether a ship possesses sufficient righting energy to withstand various types of upsetting and healing moments, such as beam winds (especially when combined with rolling), lifting of heavy weights over the side, high-speed turning and topside icing [57]. A comparison is made between the ship's corrected righting arm curve versus various heeling arm curves to determine *Arsenal Ship's* stability. Figure VIII-5 is the static stability curves for a 100-knot beam wind, showing the righting arm and heeling arm. Stability is considered satisfactory if:

- The heeling arm at the intersection of the two curves is less than 60-percent of the maximum righting arm; and
- The area between the curves to the right of the intersection is at least 1.4 times the area between the curves to the left of the intersection.

It is apparent from this diagram that *Arsenal Ship* is capable of withstanding such winds.

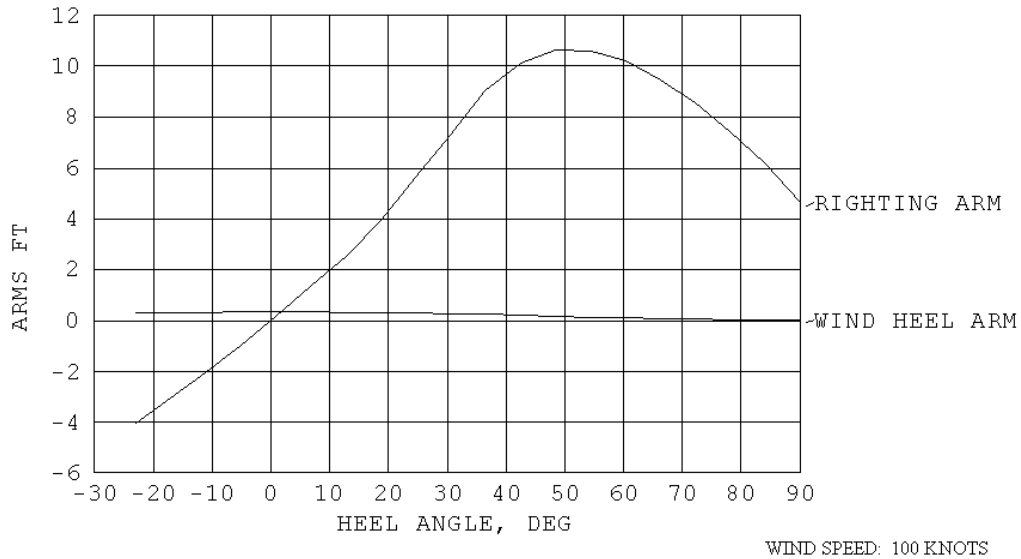

**Figure VIII-5: Static Stability Curve for 100 kt Beam Winds**

Figure V III-6 shows the same comparison for a high speed turn heeling effect. In this case, stability is considered satisfactory if:

- The angle of steady heel does not exceed 15 degrees;
- The heeling arm at the intersection of the two curves is less than 60-percent of the maximum righting arm; and
- The reserve dynamic stability (the area between the curves to the right of the intersection) is at least 40-percent of the total area under the righting arm curve.

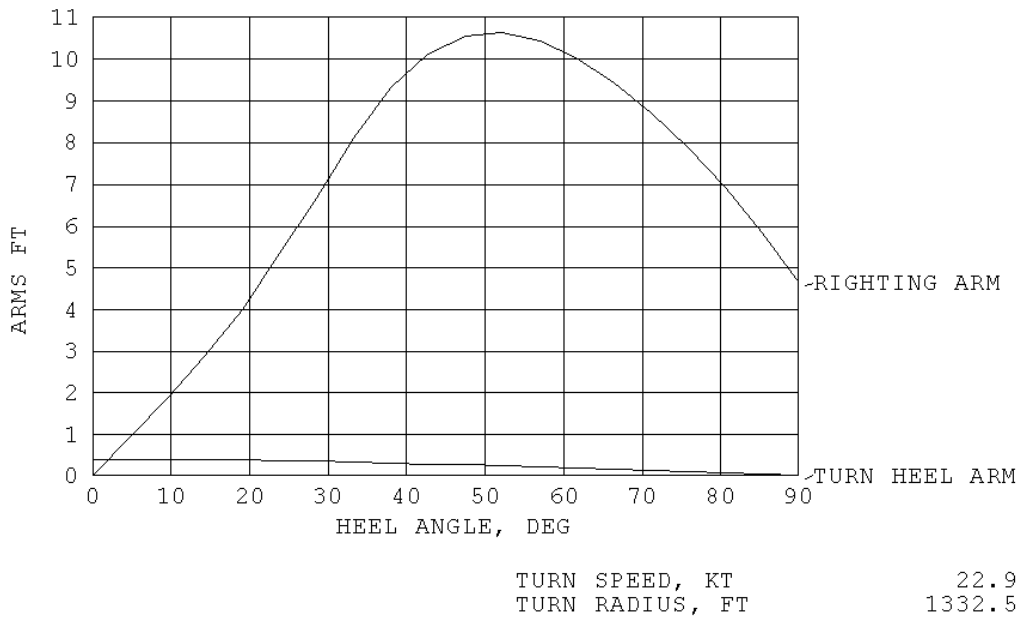

**Figure VIII-6: Static Stability Curve for High Speed Turn**

Once again, the diagram shows that these criteria are easily met.

Finally, the damaged static stability curve is shown in Figure VIII-7. This shows the effect of beam winds after damage is suffered. For this analysis, stability is considered satisfactory if:

- The static trimmed-heeled waterline after damage does not submerge the margin line;
- The static heel angle without wind effects does not exceed 15 degrees;
- Adequate dynamic stability (the area between the curves to the right of the intersection) exists to absorb the energy imparted on the ship by moderately rough seas in combination with beam winds.

This diagram is evidence that *Arsenal Ship* is highly stable, even after damage.

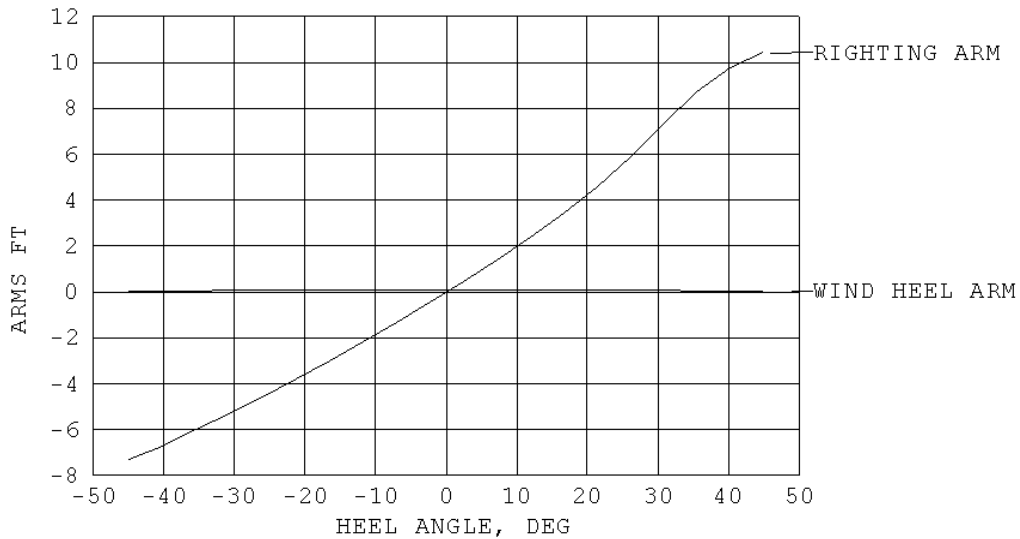

**Figure VIII-7: Damaged Static Stability Curve**

## F. HULL STRUCTURE

The T-AO 201 class auxiliary ship is designed with sufficient strength to transport 26,000 long tons of fuel in the ship's midsection. Although the full load displacement of *Arsenal Ship* is approximately equal to the T-AO, the *Arsenal Ship*'s load is more evenly distributed than the T-AO. Additional structure is added to the interior of *Arsenal Ship* as well, which also aids in structural strength. A preliminary structural analysis was performed using ASSET to determine the number, sizes and weight of support structure (i.e., scantlings).

ASSET calculates the hogging and sagging bending moments based on the ship's weight distribution and section modulus. From these, the primary stresses at the keel and main deck are computed for hogging and sagging conditions. These stresses are then used

to design the number and size of scantlings for various materials. Figure VIII-8 shows the midship section of the *Arsenal Ship* determined by ASSET. It should be noted that the double-hull and longitudinal bulkheads are not considered in this midship section. This is due to a limitation of the ASSET program, and results in an under-estimation of the ship's overall strength and over-design of the scantlings.

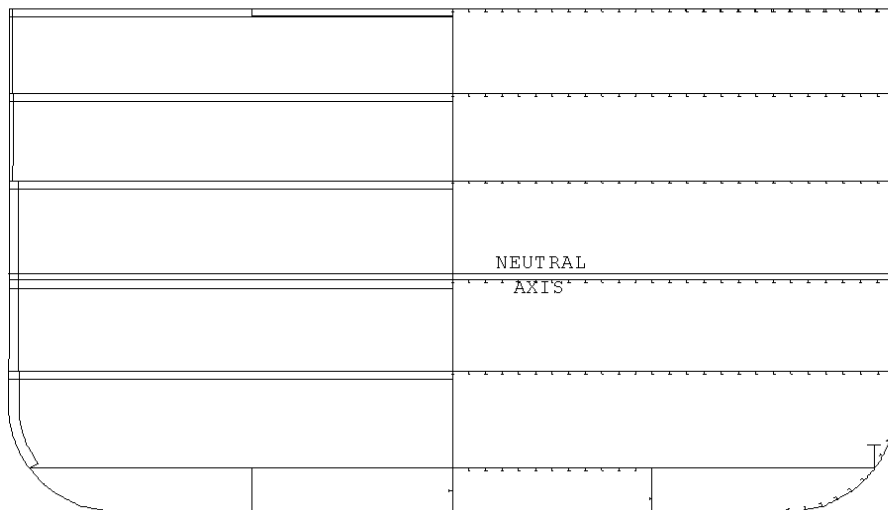

**Figure VIII-8: *Arsenal Ship*'s Midship Section**

## IX. COST ESTIMATION

The modified-repeat design of the T-AO, together with the original construction of the T-AO using commercial standards, makes cost estimation a very difficult process. Cost figures for standard military construction of naval vessels are used in this study. The analysis spreadsheets are adjusted for the *Arsenal Ship* and T-AO because historical data for construction of this type of vessel is unavailable. The known unit sailaway cost of the T-AO is \$167 million (1995) [42]. This price is scaled according to the *Arsenal Ship*'s design and construction techniques.

First, the material cost estimating relationships (CER) for ship's weightlist breakdown structure (SWBS) groups 100, 200 and 500 are reduced by 20 percent of the military specification (MIL-SPEC) values. Next, the material CERs for weight groups 320 and 340 are reduced by 25 percent. These adjustments are applied to the *Arsenal Ship* and the T-AO. Finally, since the *Arsenal Ship* is a modified-repeat design, the labor CERs are reduced by 15 percent, and the non-recurring engineering hours are significantly reduced (App. B).

The cost analyses are conducted using identical labor rates, learning curves, profit, and other costing variables for the *Arsenal Ship* and the T-AO. The weight breakdowns are obtained from the weight module of the Advanced Surface Ship Evaluation Tool (ASSET) computer model for each ship. The labor associated with installing weapons systems is accounted for in the *Arsenal Ship* computer run, however, the procurement costs of the systems are not included until after the construction costs are scaled. Inclusion of these prices in the analysis skews the data, giving the *Arsenal Ship* a less



expensive than it realistically is. Appendix B contains the preliminary cost analyses performed on the T-AO and *Arsenal Ship*.

Table X-1 shows the scaled combat systems costs. Combining the ASSET model cost data, the combat systems costs, and a discount acquisition cost for the T-AO, the resultant unit sailaway cost for the *Arsenal Ship* is **\$ 487 million**. This cost is well below the sailaway cost cap imposed by Defense Advanced Research Project Agency (DARPA).

512 MK-41 VLS Launchers	\$ 215 M
CEC and ATWCS	\$ 20 M
Communications Systems	\$ 24 M
Self Defense Systems	\$ 11 M
TOTAL	\$ 270 M

**Table IX-1. Combat Systems Estimated Costing Data**

## **X. DISPOSAL OF WASTE AT SEA**

Modern naval ships are expected to meet increasingly stringent environmental regulations. The *Arsenal Ship* is no exception to this, and to meet these challenges, the ship is designed to be an environmentally sound ship [58]. This designation requires that the ship must conduct operations, in port and at sea, in such a manner as to minimize or eliminate any adverse impact on the marine environment. An environmentally sound ship has the following attributes: [59]

- Environmental compliance
- No significant adverse environmental impact
- Wastes treated or destroyed on board to the maximum extent practicable
- No inappropriate dependence on shore facilities for waste off-load
- Minimal logistical costs for waste management
- Minimal use of hazardous materials on board.

The diplomatic, logistical, economical, environmental and public relations consequences of non-compliance are serious and require such a design.

Simply stated, the *Arsenal Ship* must be capable of operating world-wide with minimal potential for regulatory constraint or dependence on shore facilities for waste management support. To meet this challenge, the *Arsenal Ship* design incorporates several shipboard systems that destroy or appropriately treat waste generated on board.

The following wastes and emissions are considered:

- Oily waste
- Non-oily wastewater
- Solid waste

Oily waste and waste oil are unavoidable byproducts of operating ships. There are three primary sources for oily waste: bilge, ballast and waste oil storage tanks. Navy policy limits the oil content of ship discharges to less than 20 ppm within 12 nm of land and to less than 100 ppm beyond 12 nm. To meet these requirements, the *Arsenal Ship* employs an Oil-water Separation (OWS) and an Oil Content Monitoring (OCM) systems. The U.S. Navy has two OWS designs, and one OCM design, in production that are suitable for this requirement. [60].

Non-oily wastewater includes blackwater (sewage) and graywater (discarded water from deck drains, heads, showers, galley, etc.). With regard to sewage and graywater, the Navy policy requires that ships employ marine sanitation devices (MSD) which prevent the discharge of untreated sewage within 3 nm from land. To meet this requirement, the *Arsenal Ship*, uses the existing collection, holding and transfer (CHT) system of the T-AO oiler. Sewage and graywater production are directly proportional to the number of personnel aboard, therefore with a minimally manned crew, the generation of such waste is expected to be significantly less than the capacity of the existing CHT system. An additional consideration precluding enhancement to the CHT system, is that the *Arsenal Ship* rarely operates within 3 nm from land.

The majority of shipboard solid waste is comprised of the following: paper, metal, glass, food waste, plastic waste and medical waste. These waste items are regulated and managed differently. For non-plastic waste, Navy policy prohibits discharge within 3 nm of any coastline, with a relaxation to this requirement for pulped garbage discharge beyond. To handle the disposal of non-plastic waste, the *Arsenal Ship* is equipped with a solid waste shredder (SWS) for processing of metal, glass and ceramic waste, and a trash

pulper for the processing of paper, cardboard and food waste. Both items have completed operational testing on USS George Washington (CVN-73) [61] and are ready for installation on *Arsenal Ship*.

For plastic waste, the Navy continues to intimate a future policy of zero discharge. To achieve this on *Arsenal Ship*, the ship is outfitted with a plastics waste processor (PWP). This system heats, compacts and sanitizes plastic waste, reducing large volumes of plastic to easily handled dense disks. This system has also completed testing on USS George Washington (CVN-73) [59] and is also ready for installation.

Medical waste generation on board *Arsenal Ship* is expected to be minimal. The small crew size, coupled with the stringent medical screening requirements, reduces the demand for medical attention and thus medical waste processing. Most medical procedures will be performed at medical facilities off of the ship (battlegroup asset, ashore) therefore, the *Arsenal Ship* is equipped with only the minimum requirement for medical waste disposal.

By designing the *Arsenal Ship* as an environmentally sound ship, operations are not impaired by environmental regulatory issues. The installation of systems that reduce or destroy waste are integral to meeting this challenge.

## XI. DESIGN EVALUATION

Overall, this design meets the objectives of the proposed *Arsenal Ship* concept. Although many objectives in the SCD and CONOPS are subjective for ship designers, there are several that are measurable and crucial for a successful design. These are listed in priority in the design philosophy. An attempt is made and documented where the design can be measured against an objective. Detailed explanations are provided to justify objectives that are subjective in nature. Overall, this design not only demonstrates the ability to meet mission needs, but is also straight- forward in its design reasoning.

First and foremost, the most important objective for the design is acquisition cost. This design meets that objective. Cost drives the entire design and is the reason for selection of a modified-repeat concept. The cost of the combat system suite is considered before HM&E systems. Quantifying exact costs for equipment designed around Advanced Concept Technology Demonstrator (ACTD) progress is difficult. A concerted attempt is made to quantify these costs based on estimates received from researchers. The figures may be debatable, but estimates produced by others are subject to the same margin of error. The HM&E costs are more tangible. The figures presented in this category are based upon extrapolation of known costs of similar designs. Hence, these have a much smaller margin of error. The combined-costs for the combat system suite and HM&E systems are credible and meet the \$550 million cost ceiling objective.

Another important objective in the design is the ability of the *Arsenal Ship* to operate as a remote-firing battery. Technology for remote-firing capability is still in the research and development stage. There is sufficient confidence, however, that it will be

cost-effective and ready for installation on the first *Arsenal Ship*. The system will be capable of remotely-firing SM-2, TLAM, and ATACMS from other targeting platforms, using the Advanced Tactical Weapon Control System on the *Arsenal Ship*. If this technology fails, the entire *Arsenal Ship* delivery schedule will be in jeopardy.

*Arsenal Ship* has a minimal amount of sensors, aside from CEC and standard communications. *Arsenal Ship's* self-defense capability is driven by reduction in costs and manning. The vessel's self-defense relies on EW systems (i.e., AIEWS, IR, RF decoys) and RAM. These systems, in conjunction with mass tonnage and inherent survivability features, meet the CONOPS objects.

Manning reduction is another important design goal. The objective is a maximum crew of 50 personnel. This *Arsenal Ship* is designed to have a crew of 44. Automated-systems are used wherever possible, with sufficient redundancy to reduce system failure. In addition, standard naval operating practices and procedures are reviewed and tailored for a minimum manning concept. Safety is looked at first in every case. Some special evolutions are removed all together. This leaves *Arsenal Ship* without the capability for conducting that evolution. However, in such cases, a full explanation for removal is presented in detail. The reduced-manning concept also places a large percentage of equipment repairs on shore-based, deployable if necessary, maintenance teams. Equipment is chosen with minimum maintenance requirements in mind.

As mentioned above, cost considerations are paramount in this design. Therefore, *Arsenal Ship* is designed from a modified-repeat T-AO 201 class auxiliary ship with double hull. Alternative hull forms are reviewed, however, a new hull design removes money that can be used to purchase valuable combat system equipment. Not only is this

hull a proven design, but it also has the added double-hull benefit. The double-hull has greater survivability characteristics over conventional monohulls. Different engines are used to account for a higher sustained-speed. Taking into account these modifications, HM&E costs are still within an acceptable range for supporting the combat system package selection. The T-AO 201 class auxiliary ship with double-hull is believed to be the best and most cost-effective solution for the *Arsenal Ship* concept.

This report is only a "first turn around the design spiral." There is sufficient confidence that the detailed design stage will prove that this *Arsenal Ship* surpasses all CONOPS and SCD objectives. The *Arsenal Ship* is designed with state-of-the-art technology for the warfighter of the 21<sup>st</sup> century. It is a design which supports not only naval surface warriors, but also aviators, submariners, and infantrymen. It provides the first significant platform for joint-service missile targeting and sets the stage for follow-on joint military hardware.

In summary, this design is based on at-sea experience and thorough analysis of warfighters and engineers from the Navy, Coast Guard, and Marine Corps, and presents a realistic solution to the Navy's call for an *Arsenal Ship* of the 21<sup>st</sup> century.

## LIST OF REFERENCES

1. U.S. Navy, Office of the Chief of Naval Operations and Commandant of the Marine Corps, , 1994
2. Commandant of the Marine Corps, *Operational Maneuver From the Sea*, Washington D.C., 1996
3. Office of the Chief of Naval Operations, *2020 Vision*, Washington, D.C., 1996
4. DARPA, *Arsenal Ship Concept of Operations*, 23 May 1996
5. DARPA, *Arsenal Ship Capability Document*, 23 May 1996
6. R. Ball, C. Calvano, "Establishing the Fundamentals of a Surface Ship Survivability Design Discipline," *Naval Engineers Journal*, Jan. 1994, p. 72
7. Raines, D., "Ship Affordability," *Naval Engineer's Journal*
8. NWP-14revE, *Replenishment at Sea*
9. Carvey, BM2, USS Stethem, Personal interview, Aug. 17, 1996.
10. NWP-42revJ chg1UC3, *Shipboard Helicopter Operations*
11. USS Stethem Deck Division PMS Schedules, 43PI, Aug 17, 1996
12. *Smart Ship Implementation Proposal FLEET-0022, Automated Division Officer's Notebook: COMPASS for Windows*
13. *Smart Ship Implementation Proposal FLEET-0023, Shift All Hands to Coveralls.*
14. Barker, R., CAPT, *Smart Ship Project*, Presentation, Core Installation slide, Jun. 11 1996.
15. Sperry Marine, *Vision 2100 Voyage Management System VT*. Sperry Marine Inc., U.S., 1994
16. Dahl, Ernest, A., *TWARSES - Two Wire Automatic Remote Sensing Evaluation System Training Manual*. Naval Surface Warfare Center, Port Hueneme Division, Code 4L03, Port Hueneme, CA.
17. *Smart Ship Implementation Proposal FLEET-0020, Standard Monitoring and Control System (SMCS).*
18. CAE Electronics LTD. Standard Monitoring Control System (SMCS). CAE Electronics LTD., Arlington, VA.



19. *Smart Ship Implementation Proposal FLEET-009, Integrated Condition Assessment System (ICAS).*
20. *Smart Ship Implementation Proposal FLEET-010, Damage Control System (DCS).*
21. CAE Electronics LTD, *Damage Control System (DCS).* CAE Electronics LTD., Arlington, VA.
22. *Smart Ship Implementation Proposal FLEET-042, Coordinated Physical Security System (COPS).*
23. Naval Surface Warfare Center, Port Hueneme Division, Combat Systems Department
24. Naval Surface Warfare Center, Port Hueneme Division, Verticle Launch System Department
25. Rothe, Michael, NAVSEA PEO (TAD) D111, Telephone interview, Aug. 15, 1996.
26. Naval Research Labs, Surface EW Division, *SLQ-32A(V) Short Course*, Presentation
27. PEO (TAD), *Rolling Airframe Missile (RAM)*, Program Decision Meeting, 5
28. PEO (TAD), *NULKA Information Briefing*, Presentation
29. Surface Force Tacnote, X20050-1-94.DARPA,
30. Center for Naval Analysis, NSFS COEA, Alexandria, VA, Dec 93, May 94, Aug 94, Oct 94
31. NAVSEA Fax, ONR FY 98 Navy Advanced Technology Demonstration VGAS - Vertical Guns for Advanced Ships
32. Dr. Randy Rohr HQ/DNA, VGAS - Vertical Guns for Advanced Ships Power Point Presentation, 28 Nov 95
33. Ange, Chris, *Naval Surface Fire Support 5-Inch MK 45 Gun Mount Modification*, Surface Warfare Magazine Vol.21 No.3, Alexandria, VA, May/June 1996
34. Lyons, Kenneth T., *Naval Surface Fire Support Extended Range Guided Munition*, Surface Warfare Magazine Vol.21 No.3, Alexandria, VA, May/June 1996
35. Morral, CAPT Dennis, *Naval Surface Fire Support Fire Support Missile Options*, Surface Warfare Magazine Vol.21 No.3, Alexandria, VA, May/June 1996
36. Liese (PMS 429C1), David and Morral (PMS 429), CAPT Dennis, *Naval Surface Fire Support Technology Overview*, Power Point Presentation, 31 July 1996
37. Blosser, O. Kelly, *Naval Surface Fire Support Mission Planning and*
38. *Joint Maritime Communications Strategy*, by Robert Taylor, Sept/Oct Surface Warfare, vol. 21, No 5,

39. *JCS Pub 1, Joint Warfare*, Joint Chiefs of Staff
40. *Command Arrangements for Peace Operations*, by Dr. David Alberts and Dr. Richard Hayes, NDU, May 1995
41. *Naval Shipboard Communications Systems*, by John Kim and Eugene Mueldorf, Prentice Hall PTR, Englewood Cliffs, NJ, 1995.
42. DeHaven, S. D., and LCDR Glen Darling, *Low Observable Multi-Function Stack*, Presentation, July, 1996.
43. DDR&E S&T Review Surface Ship Combatants Subarea Handout, 24 April, 1996.
44. J.C. Kim, and E.I. Muehldorf, *Naval Shipboard Communications Systems*, Englewood Cliffs, N.J: Prentice Hall 1995.
45. *Smart Ship Implementation Proposal FLEET-034, AN/URC-131A(V) High Frequency Radio Group (HFRG)*.
46. Law, Preston E., *Shipboard Antennas*, 2nd ed.,, Dedham, Massachusetts: Artech House, Inc 1986.
47. Williamson, J., ed., *Janes Military Communications 1995-96*, Janes Information Group, Inc.: Alexandria, VA., 1996.
48. Hemming, Leland H., *Shipboard Antennas Systems*, MacDonnell Douglas Helicopter Systems Facsimile, Mesa, AZ., Nov. 6, 1996.
49. Surface Warfare Magazine, Sep/Oct 1996, vol. 21, no. 5, Alexandria, VA.
50. Applied Physics Laboratory (APL), *The Cooperative Engagement Capability*, John Hopkins APL Digest, vol. 16, no. 4, 1995.
51. Naval Surface Warfare Center, Port Hueneme Division, Underway Replenishment Department
52. T-AO costing data conversation with Contracting Officer, Supervisor of Shipbuilding, New Orleans, LA., 10/8/96
53. OPNAVINST 9070 Ser 09/8U501139 23Sep1988 Survivability Policy for Surface Ships of the U.S. Navy
54. Bush, R. LT, and Simea, G. LT, *Operational Analysis for the Arsenal Ship*, Aug 1996

55. Naval Surface Warfare Center, Carderock Division, *Vertical Launch System Survivability Report*, 1995
56. Principles of Naval Architecture, 2<sup>nd</sup> rev., vol. 1, Society of Naval Architects & Marine Engineers, 1988.
57. Gillmer, T.C., and Johnson, B., *Introduction to Naval Architecture*, Naval Institute Press, 1982.
58. U.S. Navy, Office of the Chief of Naval Operations, *OPNAVINST 5090.1B, Chapter 19, Environmental Compliance Afloat*, 01 Nov. 1994, pp. 1-35.
59. Koss, Larry, "Technology development for environmentally sound ships of the 21<sup>st</sup> century: an international perspective", *J Mar Sci Technol*, vol. 1, 1996, pp. 127-137.
60. Koss, Larry, "Environmentally sound ships of the 21<sup>st</sup> century", white paper, Office of the Chief of Naval Operations (N452), 1992.
61. "Navy Solves its Plastics Problem," *Shipboard Environmental Update*, vol. 1, no. 1, Sep 1995, pp. 3-4.
62. Myers, John, Foam-In Salvage System. Internet page of Battelle Corporation, <http://www.battelle.org/oe/FIS.html>, March, 1996.

## APPENDIX A

### Functional Analysis And Flow Diagrams

FUNCTION NAME AND NUMBER	FUNCTION PERFORMANCE AND REQUIREMENTS	TEAM
1.0 Inport/Moored Operations	Extended Inport/Moored Operations with extensive shore support	HOC
1.1 Exchange/Load Weapons		
1.1.1 Carry 500 VLS cells (64x8=512)	MK41 VLS vertical launch system (tradeoff with CCL - Concentric Canister Launcher)	C H
1.1.2 Determine Mission Requirement Loadout	Loadout determined by Area of Operation and JCWC requirements	O
1.1.3 Load 500 cells/Exchange out-of-date weapons for maintenance	•Ordnance Inventory tracked on ROLMS (Retail Ordnance Logistics Management System) SSP-FLEET-0037 •Missile Between Maintenance Storage Time: SM2 >90 days TLAM >90 days ATACMS >90 days SLAM >90 days	C
1.2 Maintain Charts	•Electronic Chart Updates (Shoreside Support) •Sperry VMS VT (Voyage Management System) Planning&Navigation Management Station •DNC (Digital Nautical Chart) for AN/SSN-6 NAVSSI (Navigation Sensor System Interface) SSP-FLEET-0025 •CIS (Chart Inventory System) SSP-FLEET-0031 integrates with IBS (Integrated Bridge System) SSP-FLEET-0013, tracks Notice to Mariners electronically through NIN (Navigation Information Network) and is a module of Digital Chart System of IBS (Integrated Bridge System)	O
1.3 Update Crew Records	(ID Card/Service Record/Medical Record/Dental Record/Security Clearance/ Security Access) •Electronic Record Updates (Shoreside Support) •MARC (Multi-technology Automated Reader Card) SSP-FLEET-0011	O
1.4 Medical/Dental Screening	Physicals / Dental Checks / Electronic Record Updates / PRT (Shoreside Support)	O
1.5 Intelligence Briefings	•Deployment Threat Brief / Mission Assignment (Shoreside Support) •Secure Teleconferencing Capability for ONI briefs	O
1.6 Maintain Consumables / Resale Operations	•Automatic re-order on issue of item •Computer request for delivery •Bar Coding for Non-SNAP Shipboard Applications SSP-FLEET-0016 •ROM EDI (Resale Operations Management Electronic Data Interchange) SSP-FLEET-0038	HOC
1.7 Physical Security	Protection of ship and crew	HOC
1.7.1 External	•Quarterdeck Video Surveillance System SSP-FLEET-0040 •MARC (Multi-technology Automated Reader Card) SSP-FLEET-0011 for crew ID/muster/status	
1.7.2 Internal	•MARC (Multi-technology Automated Reader Card) SSP-FLEET-0011 •COPS (Coordinated Physical Security System) SSP-FLEET-0042 for security access	
2.0 Underway Preparations	Preparations for Getting Underway	HOC

2.1 Tailor Weapons Loadout	Specific Theater / Mission Loadout	C
2.2 System Checks	Engineering System Checks Combat Systems System Checks	H C
2.2.1 Ship Control	•IBS (Integrated Bridge System) SSP-FLEET-0013 •Sperry VMS VT (Voyage Management System)	
2.2.2 Navigation	AN/SSN-6 NAVSSI (Navigation Sensor System Interface) SSP-FLEET-0025	
2.2.2.1 Navigation Receivers	•WRN-6 GPS Receiver ?antenna requirement? •SRN-25 (Omega, Transit, GPS) ?antenna requirement?	
2.2.2.2 Inertial Navigation	•WSN-5 INS •Ring Laser Gyro Navigator (RLGN)	
2.2.3 Engineering Systems	•ICArsenal Ship (Integrated Condition Assessment System) SSP-FLEET-0009 •SMCS (Standard Monitoring Control System) SSP-FLEET-0020	
2.2.4 Ship Integrity	DCS (Damage Control System) SSP-FLEET-0010	
2.2.5 Combat Systems	•Input to SMCS (Standard Monitoring&Control System) SSP-FLEET-0020 • Input to ICAS (Integrated Condition Assessment System) SSP-FLEET-0009	
2.3 Refuel (Top-Off)	100% fuel on departure (Enough for 90 days)	H
2.4 Plant Lightoff	Main Engines / Generators up and online	H
2.5 Shift Services	Shift from shore to ship services	H
2.6 Initialize/test PNAV	Energize / Initialize Precision Navigation (pcode-GPS) Inertial Navigation Equipment	O
2.7 SOC Detachment	Embark Special Operations Capable (SOC) Detachment and/or Equipment	O
2.8 Shift Communications	•Communication Equipment Checks •Shift comm guard from shore to ship	C O
2.9 Load Mission Stores	Load Mission Specific Stores	HOC
3.0 Departure Operations	Sea&Anchor Detail to Underway	HOC
3.1 Sea and Anchor Detail (Special Evolution)	Watch Station Positions (minimum manning) Bridge (?) Engineering (?) Deck (?) CIC/Comms (?)	HOC
3.1.1 Linehandlers / Tugs	Manning (4) Linehandlers per station to work lines / receive tugs (OPS Special Evolutions Doc)	O
3.1.2 Anchor Detail	Manning (6) (OPS Special Evolution Doc)	O
3.1.3 Navigation Detail	Manning (?) / Electronic Assisted Piloting	O
4.0 Transit to theater		HOC
4.1 Mission Briefing	Crew Briefings by Closed Circuit TV / Scenario Drills	O
4.2 Disposal of Waste at Sea	Federal / International Environmental Regulations Store/Compact/Incinerate/Discharge Overboard Method and Equipment	O H
4.2.1 Solid Waste	•For Dry Waste - Strachan&Henshaw Waste Processing Machine ( <i>Navy International - JAN/FEB 1993</i> ) •Large Waste Pulper - SSP-FLEET-0019	
4.2.2 Plastics	Plastic Waste Processor SSP-FLEET-0015	
4.3 Discharges Over the Side	Federal / International Regulations Required Intake/Discharge	O H

5.0 Theater Operations	90 day employment	HOC
5.1 On Station Presence	Continuous Availability / Conventional Deterrence	O
5.2 Combat Operations	Employ Weapon System	C
5.2.1 Position Ship	Position for defense of ship by AEGIS Control Platform Position ship for firing arcs/blast/smoke control	H O C
5.2.2 Weapon Inventory Status to Control Platform	Weapon inventory and status sent to Control Platform MK41 VLS LCU to ATWCS	C
5.2.2.1 Missiles	Missile Inventory and Status Indications MK 41 VLS LCU (Launch Control Unit)	C
5.2.2.2 Extended Range Gun System	•Reserve Space/Weight/Power to accommodate future fit •VGAS (Vertical Gun for Advanced Ships) 155mm Manning (0) Maintenance (1-3) •Trade-off with 5inch 54 Manning (10) Maintenance (3+)	H C
5.2.3 Process Remote Missile Selection	Processing Equipment: ATWCS	C
5.2.4 Initialize Selected Missile	Specific Requirements for each missile type:	
5.2.4.1 Standard Missile	Missile Initialization Requirements: ATWCS (Advanced Tomahawk Weapon Control System) SM-2 Blk IIIA/B: SM-2 Blk IVA: SM-2 LEAP: STRIKE SM:	C
5.2.4.2 ATACMS	Missile Initialization Requirements: ATWCS ATACMS: ATACMS-BAT: ATACMS-ER:	C
5.2.4.3 SLAM	Missile Initialization Requirements: ATWCS SLAM:	C
5.2.4.4 TLAM	Missile Initialization requirements: ATWCS TLAM: TLAM-BAT: TLAM-C/D: TLAM BLKIV:	C
5.2.5 Receive Remote Launch Order	Receive Method: Primary-Data Link / Secondary Receive Equipment: CEC / LINK 16	C
5.2.6 Process Remote Launch Order	Processing Equipment: (ATWCS) Advanced Tomahawk Weapons Control System	C
5.2.7 Launch Missile / Fire Gun	•Weapons Release Authority from CWC (analogy on/off safety switch)	C
5.2.7.1 Missile Misfire	Automatic Reselect Alternative Cell	C
5.2.8 "Missile Away" Message to Control Platform	Method: Primary-Data Link / Secondary /Tertiary Equipment: CEC / LINK 16/ Link 22	C

6.0 Return Transit		HOC
6.1 Ballast/Deballast	As required for stable transit	H
6.2 Post Mission Briefs	Data Disks/Voice Recording/Computer Printout	O
7.0 Prearrival Operations		HOC
7.1 Sea Detail		HOC
7.1.1 Linehandlers	Embark Linehandlers from tugs	O
7.1.2 Anchor Detail	Automatic Keel Anchor	O
<b>8.0 Mooring Operations</b>		HOC
8.1 Tugs		O
9.0 Post-Arrival Operations	Immediately Upon Arrival	HOC
9.1 Default Missile Loadout	Reload VLS with default loadout	C
9.2 Shift Services	Shift from Ship to Shore Connections	H
9.3 Refuel	Refuel Ship (DFM - F76)	H
9.4 Secure Nonessential Systems	Shut down non-essential equipment Computer Equipment to Monitor Status	HC
9.5 Crew Change	Crew Debrief and Changeout	O
9.6 Shift Comms	Ship to Shore	OC
9.7 Load Stores	Load pre-ordered stores - Use of ship storage elevators and loadout conveyors	HC
10.0 Sustain the Crew		O
10.1 Messing	Crew and SOC Detachment	HO
10.1.1 Plan Meals		O
10.1.2 Prepare the Meals	Easy Prep Galley Operations SSP-FLEET-0024	HO
10.1.3 Serve the Meals	Self Help	O
10.1.4 Cleanup the Meal	Self Help	HO
10.1.5 Disposal of Food Waste	Large Waste Pulper SSP-FLEET-0024	HO
10.2 Provide Hotel Services		HO
10.2.1 Provide Hot Water Service		H
10.2.2 Provide Cold Water Service		H
10.2.3 Provide HVAC service		H
13.2.4 Provide Potable Water	Reverse Osmosis	
10.3 Berthing	Crew and SOC Detachment	HO
10.3.1 Provide Sanitary Head Facilities		H
10.3.2 Provide Sanitary Washroom Facilities		H
10.3.3 Provide Sanitary Linen Service		H

		OC
	•Consider Mast/Antenna Requirement	
11.1 Inport	Shore Guard	OC
11.2 Interior Communications	•Digital Pipes/Bells •Phone System •Computer LAN	
11.3 Underway Exterior Communications	•Certain Comms guarded by Control Ship •SACCS (Ship Automated Communications Control System)	OC
11.3.1 LF	Ship-Shore	
11.3.2 HF	•(HFRG) AN/URC-131A(V) High Frequency Radio Group SSP-FLEET-0034 (Ship-Ship / Ship-Submarine / Ship-Aircraft / Ship-Shore)	
11.3.3 UHF	•FLTSATCOM (Ship-Satellite) •Ship-Ship / Ship-Aircraft	
11.3.4 VHF	•Ship-Ship	



11.3.5 EHF millimeter wave	Milstar (Ship-Satellite)	
11.3.6 FLEET BROADCAST	(HSFB) AN/USQ-122A(V) High Speed Fleet Broadcast	
11.3.7 Data Link	OTH Satellite Link Tactical Data Link / Weapons Control Link	C
11.3.7.1 CEC (Cooperative Engagement Capability)	Primary	C
11.3.7.2 LINK 16	Secondary	C
11.3.7.3 LINK 22	Tertiary	
11.3.8 IFF	Transponder	C
11.3.9 TACAN	Use Control Ship	C
12.0 Maintainence	•Reliability Centered Maintenance Based Review of Planned Maintenance Requirements SSP-FLEET-0002 •Automated Tag Out System (TAGLINK) SSP-FLEET-0032	HOC
12.1 Inport		HOC
12.1.1 Equipment Monitoring and Evaluation		HOC
12.1.1.1 System Condition Monitoring		HOC
12.1.1.2 Logkeeping/Documentation		HOC
12.1.1.3 Trend Analysis		HOC
12.1.1.4 Diagnostics and Decision Making		HOC
12.1.2 System Repair		HOC
12.1.2.1 Troubleshooting	Video Conferencing / Remote System Analysis	HOC
12.1.2.1.1 Access to technical manuals		HOC
12.1.2.1.2 Access to off ship experts	Video Conferencing	HOC
12.1.2.2 Organizational level repair		HOC
12.1.2.3 Intermediate level repair		HOC
12.1.2.4 Depot level repair		HOC
12.1.3 Preventive Maintenance System and Documentation	SNAP III SSP-FLEET-0021	HOC
12.1.4 Integrated Logistic Support	SNAP III SSP-FLEET-0021	HOC
12.1.4.1 Maintenance History Reporting	SNAP III SSP-FLEET-0021	HOC
12.1.4.2 Parts Procurement	SNAP III SSP-FLEET-0021	HOC
12.1.4.2.1 Identification of Needed Parts	SNAP III SSP-FLEET-0021	HOC
12.1.4.2.2 Documentation/Failed Parts Reporting	SNAP III SSP-FLEET-0021	HOC
12.1.5 Preservation and Cleaning	Wet/Dry Vacuums	HOC
12.1.5.1 Painting	Minimize	HOC
12.1.5.1.1 Paint Locker	Paint Stick SSP-FLEET-0039	HOC
12.1.5.1.2 Paint Clean-up	Paint Stick SSP-FLEET-0039	HOC
12.1.5.1.3 Interior Spaces		HOC

12.1.5.2 Cleaning	•Easy Clean Surfaces •Wet/Dry Vacuums	HOC
12.1.5.2.1 Interior Spaces		HOC
12.1.5.2.2 Ventilation System		HOC
12.2 Maintain the Ship Underway		HOC
12.2.1 Equipment Monitoring /Evaluation	(SMCS) Standard Monitoring & Control System SSP-FLEET-0020	HOC
12.2.1.1 System Condition Monitoring	(ICAS) Integrated Condition Assessment System SSP-FLEET-0009	HOC
12.2.1.2 Logkeeping/Documentation		HOC
12.2.1.3 Trend Analysis		HOC
12.2.1.4 Diagnostics and Decision Making		HOC
12.2 Underway		HOC
12.2.1 Online System Checks	•(SMCS) Standard Monitoring & Control System SSP-FLEET-0020 •(ICAS) Integrated Condition Assessment System SSP-FLEET-0009 •Video Teleconferencing / Remote System Analysis	HOC
13.0 Survivability	Balanced Design	HOC
13.1 Damage Control	•Maximum automation •(DCS) Damage Control System SSP-FLEET-0010	HO
13.1.1 Firefighting	•Remote monitor/detection/response •Firefighting Equipment (P-100a&SCBA) SSP-FLEET-0014 •EZ Pup: Firehose Nozzle Handling Device SSP-FLEET-0036	HO
13.1.2 Flooding	Remote monitor/detection/response	HO
13.2 CBR	Citadel	HO
13.3 Passive Defense Systems		H
13.3.1 Mass Tonnage		H
13.3.2 Multiple Hull / Box Girders		H
13.3.3 Signature Reduction		H
13.3.3.1 Low Radar Cross Section		H
13.3.3.2 Acoustic Quietening		H
13.4 Active Defense Systems		
13.4.1 Gun/Missile System		C
13.4.2 Chaff/Flares		C
13.4.3 Electronic Countermeasures		C
14.0 Training	Inport vs Underway	O
14.1 Man Overboard Drill	Ship, Swimmer, Ship Boat Recovery (?) Control Ship/Helo Recovery (?)	O
14.2 Abandon Ship Drill	How to (Liferafts, Ship boats, Helo (?))	O
14.3 Imbedded Training	Built into systems (Scenarios, Failures, Operation)	HC
14.3.1 Operator	Console/System Operator training	HC

<b>19.0 ADMIN</b>		
19.1 Admin/Record Keeping	Automated Division Officer's Notebook: COMPASS for Windows SSP-FLEET-0022	

## Arsenal Ship Top Level Functional Flow Diagram

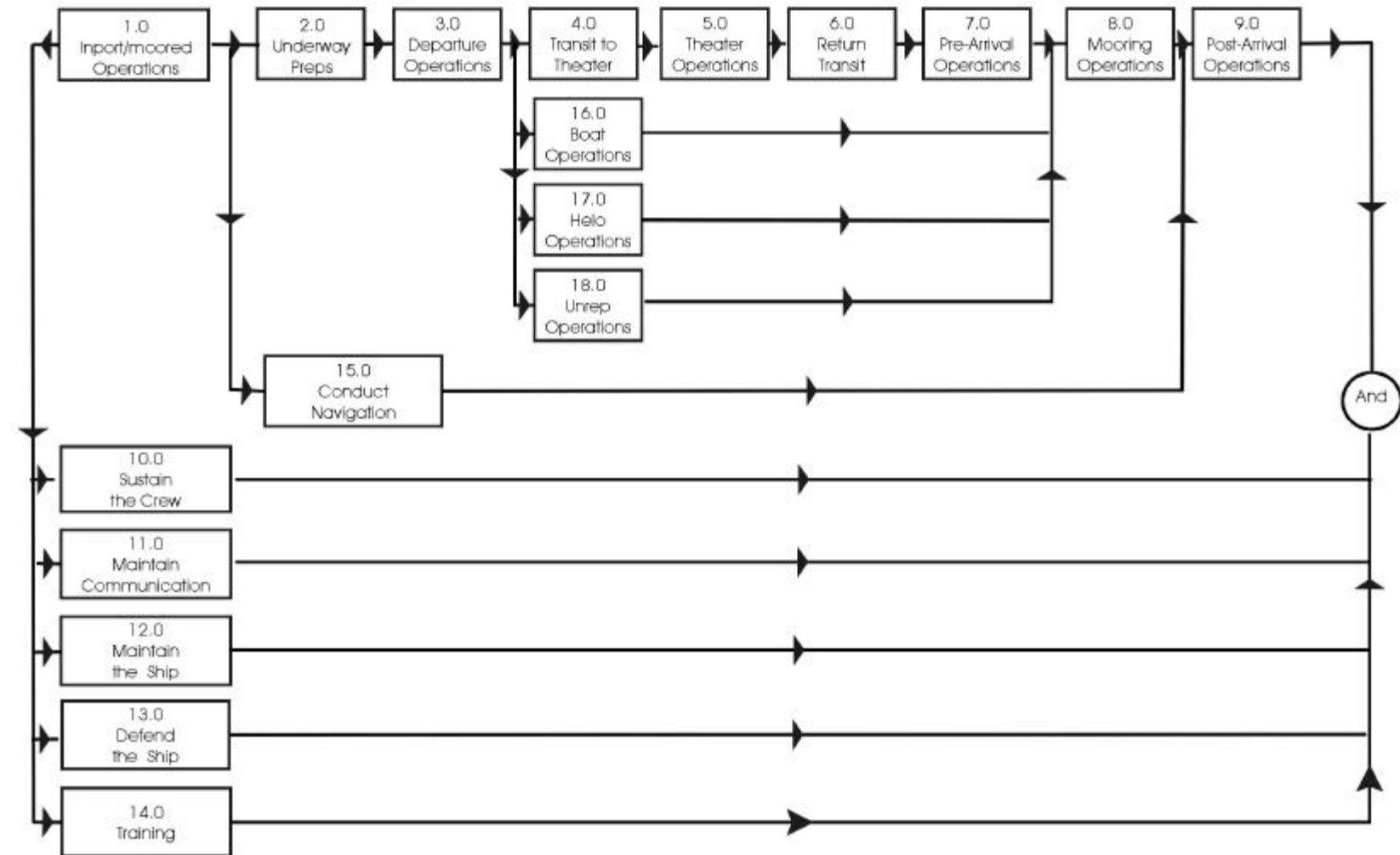

Arsenal Ship  
Inport/Moored Operations (Ref. 1.0)

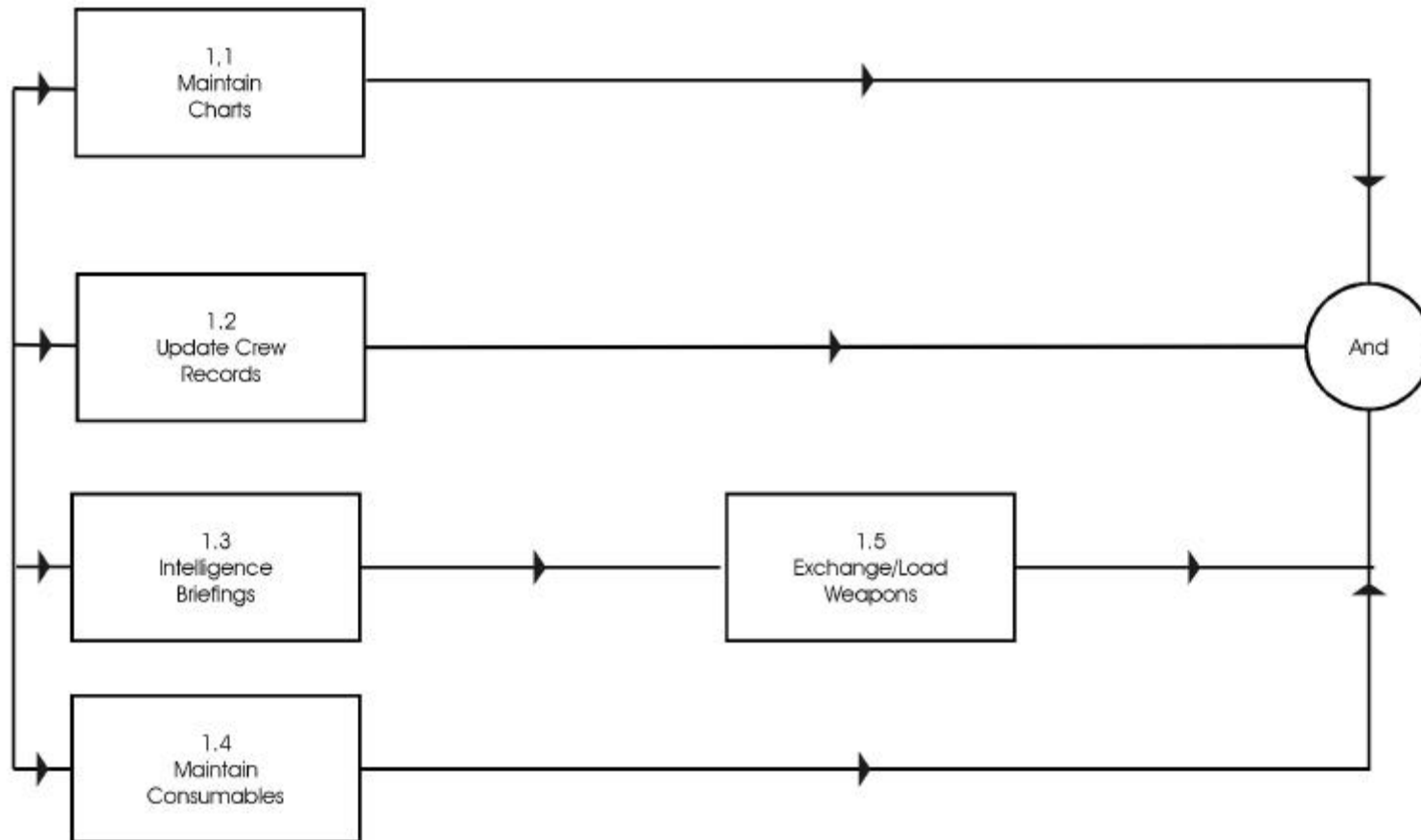

# Arsenal Ship Underway Preparations (Ref 2.0)

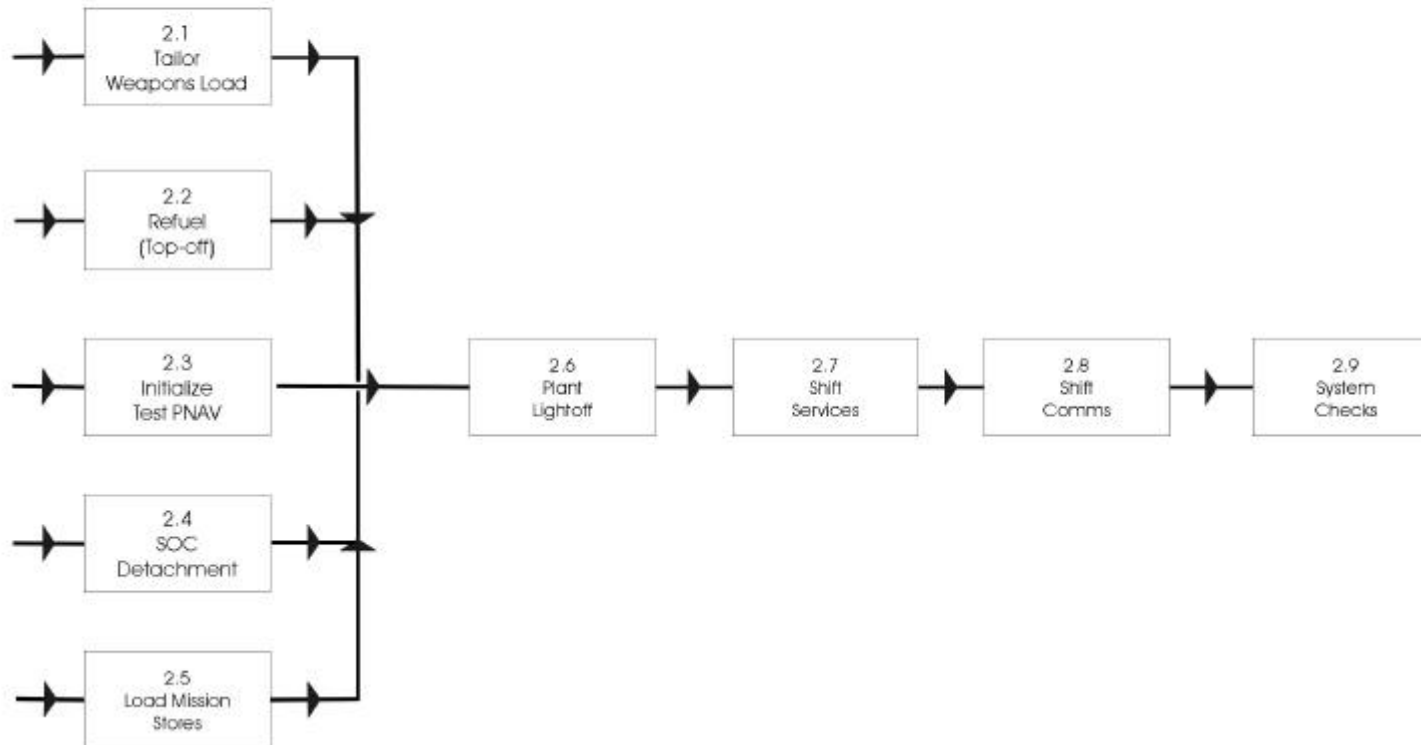

---

Arsenal Ship  
Departure Operations (Ref 3.0)

---

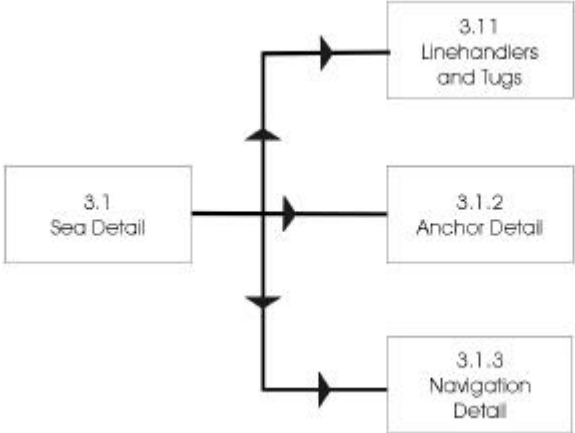

---

## Arsenal Ship Transit to Theater (Ref 4.0)

---

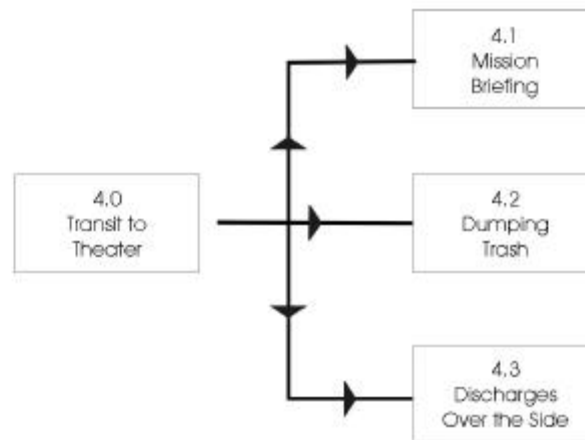



## Arsenal Ship Theater Operations (Ref 5.0)

---

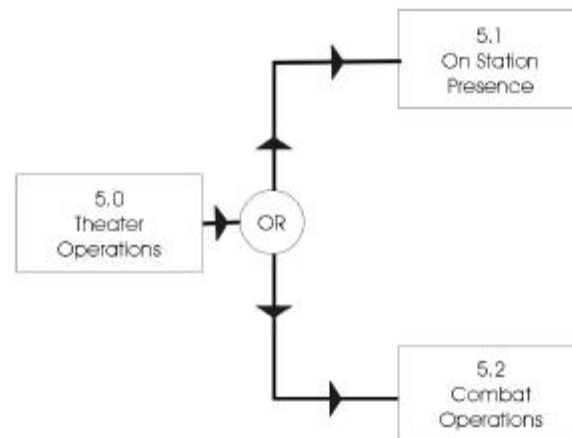

## Arsenal Ship Return Transit (Ref 6.0)

---

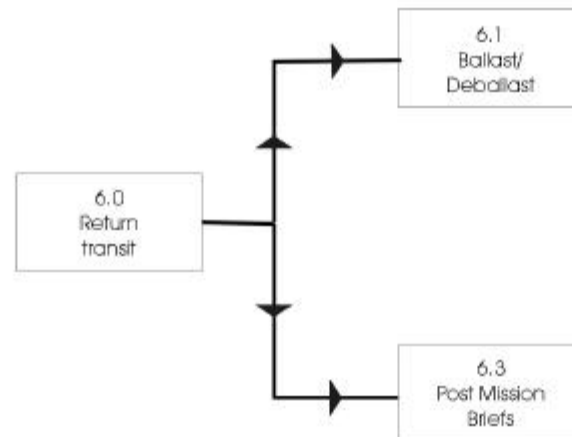

## Arsenal Ship PreArrival Operations (Ref 7.0)

---

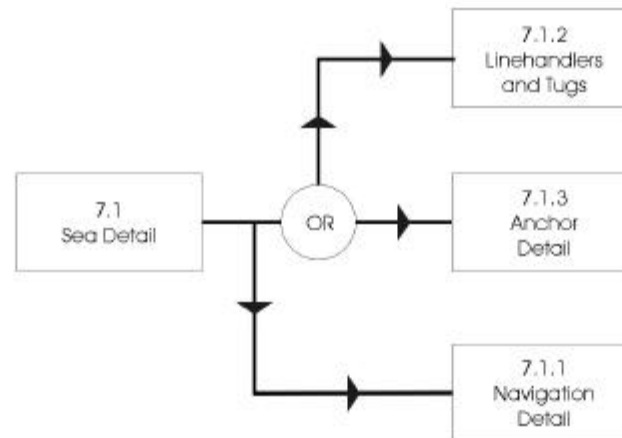

## Arsenal Ship Mooring Operations (Ref 8.0)

---

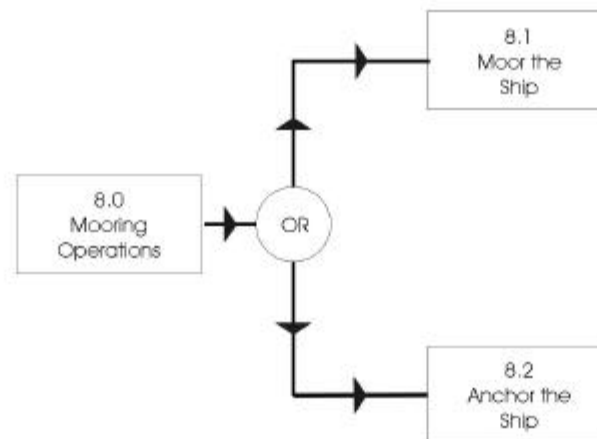

# Arsenal Ship Post Arrival Operations (Ref 9.0)

---

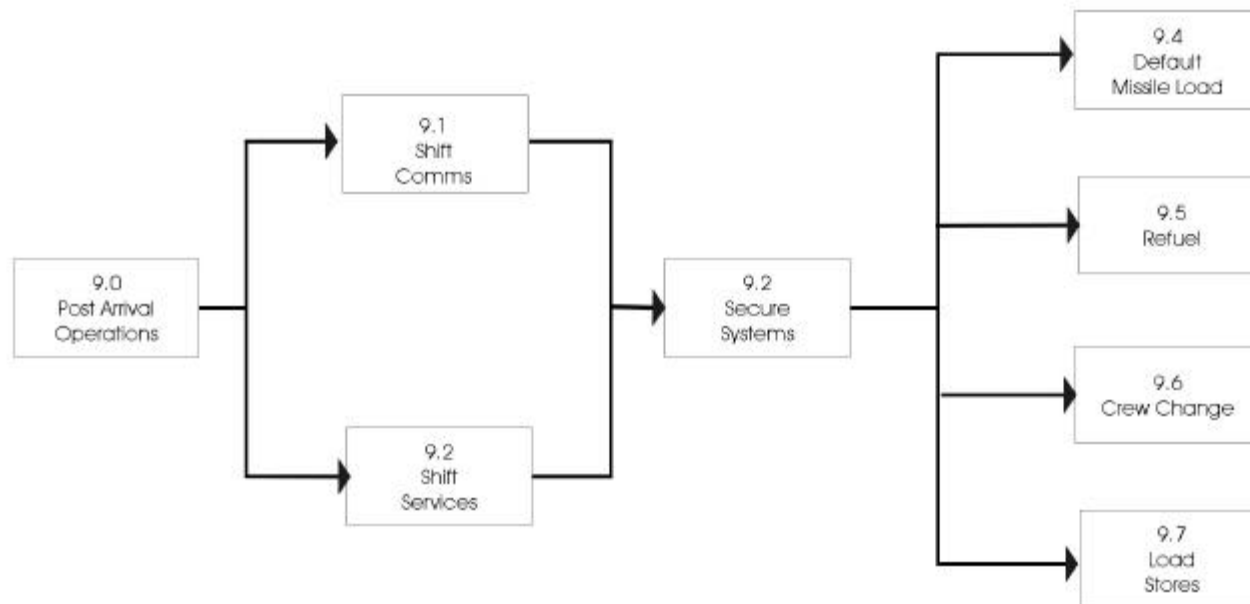

## Arsenal Ship Sustain the Crew (Ref 10.0)

---

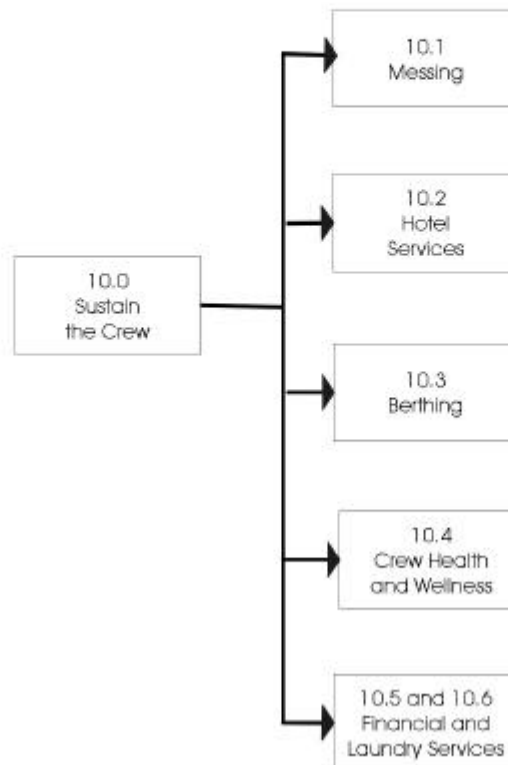

## Arsenal Ship Communications (Ref 11.0)

---

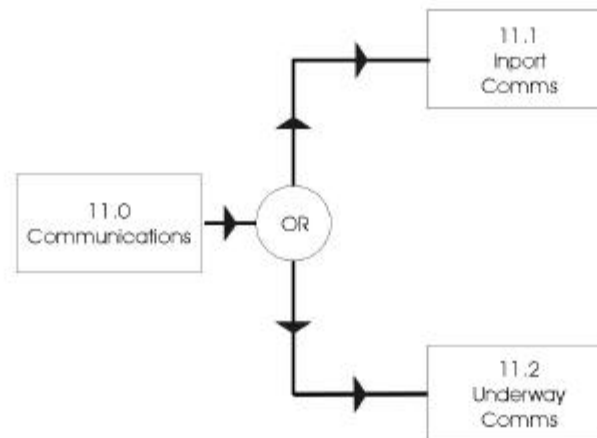

## Arsenal Ship Maintenance (Ref 12.0)

---

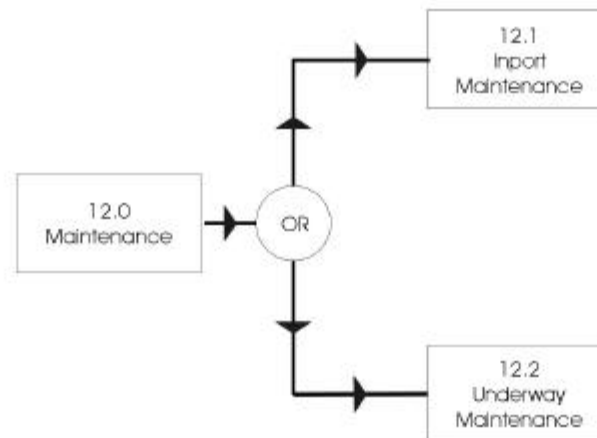



## Arsenal Ship Survivability (Ref 13.0)

---

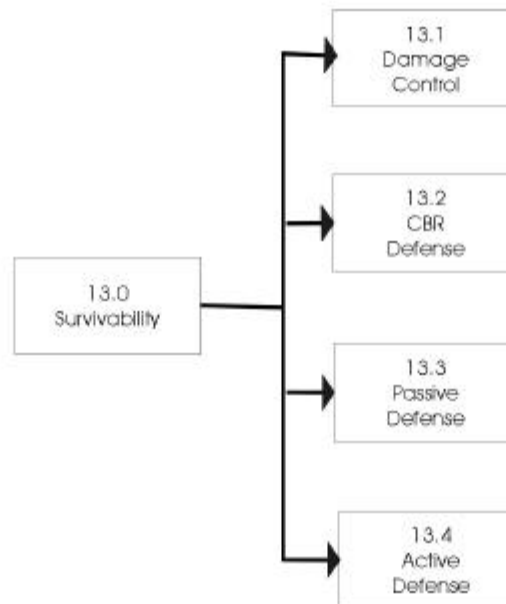

## Arsenal Ship Training (Ref 14.0)

---

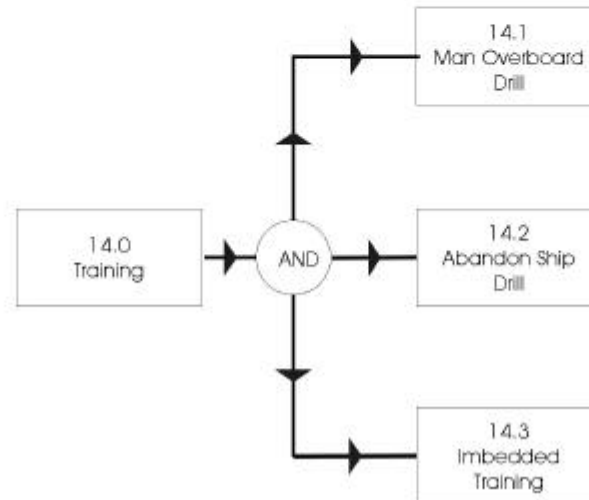

## Arsenal Ship Navigation (Ref 15.0)

---

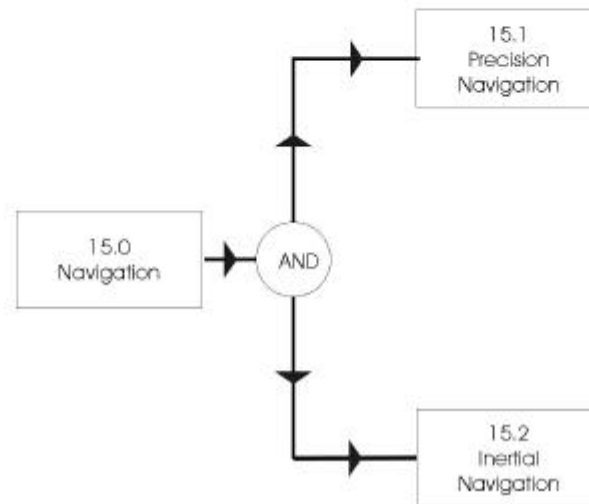

# Arsenal Ship Helo Operation (Ref 17.0)

---

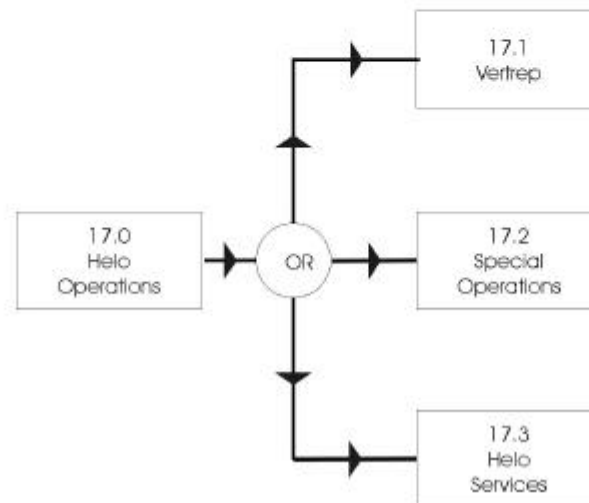

Arsenal Ship  
Unrep Operations (Ref 18.0)

---

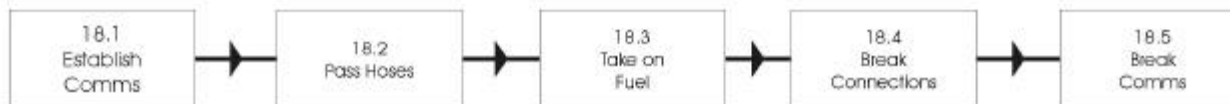

## **APPENDIX B**

### **Asset Naval Architecture Data**

**This Appendix has been deleted because of its length**

## APPENDIX C

### Arsenal Ship Cost Analysis

SWBS	Description	Weight	Other	Material CER	Material Cost	Labor CER	Labor Cost
110	SHELL + SUPPORTS	4,177.0		945	3,945,347	269	1,121,946
120	HULL STRUCTURAL BULKHDS	3,679.0		945	3,474,966	269	988,183
130	HULL DECKS	2,470.0		945	2,333,016	269	663,444
140	HULL PLATFORMS/FLATS	1,169.0		945	1,104,168	269	313,995
150	DECK HOUSE STRUCTURE	181.2		822	149,019	588	106,546
160	SPECIAL STRUCTURES	315.0		13,052	4,111,380	213	67,095
164	BALLISTIC PLATING	3,909.0		1,200	4,690,800	100	390,900
170	MASTS+KINGPOSTS+SERV PLATFORM	4.0		4,946	19,782	139	556
180	FOUNDATIONS	251.0		822	206,422	305	76,555
190	SPECIAL PURPOSE SYSTEMS	566.0		3,806	2,154,422	343	194,138
210	ENERGY GEN SYS (NUCLEAR)						
220	ENERGY GENERATING SYSTEM (NONNUC)						
230	PROPULSION UNITS	731.0	57,750	115	6,612,375	178	130,118
240	TRANSMISSION+PROPULSOR SYSTEMS	414.0	57,750	50	2,887,500	138	72,105
243	SHAFTING	108.5	317	16002	5,069,749		
250	SUPPORT SYSTEMS	96.0	32,500		0	350	33,600
260	PROPUL SUP SYS- FUEL, LUBE OIL	116.0	32,500	29,533	3,425,847	1,200	139,200
290	SPECIAL PURPOSE SYSTEMS	55.0	32,500		0		0
310	ELECTRIC POWER GENERATION	170.0	7,500	650	4,875,000	3	21,733
320	POWER DISTRIBUTION SYS	372.0	3,000,000	73,747	10,636,094	1,100	409,200
330	LIGHTING SYSTEM	59.0		5,450	321,550	1,130	66,670
340	POWER GENERATION SUPPORT SYS	43.0	3,000,000	10,909	1,573,290	1,600	68,800
390	SPECIAL PURPOSE SYS	17.0		788	13,396	400	6,800
410	COMMAND+CONTROL SYS	10.0			0	200	2,000
420	NAVIGATION SYS	6.8			0	200	1,360
430	INTERIOR COMMUNICATIONS	17.0			0	200	3,400
440	EXTERIOR COMMUNICATIONS	13.0			0	200	2,600

450	SURF SURV SYS (RADAR)	1.2		0	200	240
460	UNDERWATER SURVEILLANCE SYSTEMS			0	200	0
470	COUNTERMEASURES	70.0		0	200	14,000
480	FIRE CONTROL SYS	0.0		0	200	0
490	SPECIAL PURPOSE SYS	4.6		0	200	920
510	CLIMATE CONTROL	189.0	26,294	4,969,566	420	79,380
520	SEA WATER SYSTEMS	257.0	40,564	10,424,948	577	148,289
530	FRESH WATER SYSTEMS	129.0	27,226	3,512,154	450	58,050
540	FUELS/LUBRICANTS,HANDLING+STORAGE	200.0	33,700	6,740,000	230	46,000
550	AIR,GAS+MISC FLUID SYSTEM	415.0	56,212	23,327,980	550	228,250
560	SHIP CNTL SYS	138.0	11,220	1,548,360	300	41,400
570	UNDERWAY REPLENISHMENT SYSTEMS	0.0	6,428	0	150	0
580	MECHANICAL HANDLING SYSTEMS	266.0	13,482	3,586,212	220	58,520
590	SPECIAL PURPOSE SYSTEMS	160.0	1,510	241,600	240	38,400
610	SHIP FITTINGS	24.4	55,033	1,342,805	750	18,300
620	HULL COMPARTMENTATION	455.7	11,160	5,085,612	630	287,091
630	PRESERVATIVES+COVERINGS	356.0	10,789	3,840,884	420	149,520
640	LIVING SPACES	36.4	29,677	1,080,243	1,050	38,220
650	SERVICE SPACES	16.7	26,174	437,106	115	1,921
660	WORKING SPACES	38.9	27,376	1,064,926	248	9,647
670	STOWAGE SPACES	22.0	86,901	1,911,822	10	220
690	SPECIAL PURPOSE SYSTEMS	0.4	35,511	14,204	590	236
710	GUNS+AMMUNITION				200	0
720	MISSILES+ROCKETS	906.0			200	181,200
730	MINES				200	0
740	DEPTH CHARGES				200	0
750	TORPEDOES				200	0
760	SMALL ARMS+PYROTECHNICS	0.8			200	160
770	CARGO MUNITIONS				200	0
780	AIRCRAFT RELATED WEAPONS				200	0
790	SPECIAL PURPOSE SYSTEMS	7.1			200	1,420
F10	SHIPS FORCE	5.5				
F20	MISSION RELATED EXPENDABLES+SYS	1,760.0				



F30	STORES	22.0	
F40	LIQUIDS, PETROLEUM BASED	12,298.	
		0	
F50	LIQUIDS, NON-PETRO BASED	134.0	
Total 1991 Material Cost:		126,732,545	
Total 1996 Material Cost:		146,917,754	
1996 Cost of 512 VLS Cells:		0	
1996 Cost of Command & Control Systems:		0	
Total Reference Labor Hours:		11,672,566	'Ship Assembly and Support Labor
Learning Curve Exponent:	95.00%		SASLabor = 0.478 * Labor
Total 1996 Lead Ship Labor Hours:		12,933,591	
Total 1996 Second Ship Labor Hours:		12,286,911	'Integration and Engineering Labor
Total 1996 Third Ship Labor Hours:		11,923,723	IELabor = 0.186 * Labor
Total 1996 Fourth Ship Labor Hours:		11,672,566	
Total 1996 Fifth Ship Labor Hours:		11,481,402	'Program Management Labor
Total 1996 Sixth Ship Labor Hours:		11,327,536	ProgManLabor = 0.194 * Labor
1996 Labor Cost per Hour:		25.0	
Total 1996 Lead Ship Labor Cost:		323,339,768	
Total 1996 Second Ship Labor Cost:		307,172,780	
Total 1996 Third Ship Labor Cost:		298,093,065	
Total 1996 Fourth Ship Labor Cost:		291,814,141	
Total 1996 Fifth Ship Labor Cost:		287,035,053	
Total 1996 Sixth Ship Labor Cost:		283,188,412	
Non-recurring Engineering Hours:		650,000	
Engineering Burdened Rate:		45.0	
Non-recurring Engineering Cost:		29,250,000	

Shipyard General & Administrative Overhead:	6.50%
Shipyard Insurance:	1.00%
Shipyard Contingency:	10.00%
Shipyard Profit:	4.00%
Total Fee + Overhead Rate:	22.98%
Navy Program Cost Factor:	1.00%

Total 1996 Acquisition Costs

Non-recurring Engineering Cost:	29,542,500
Lead Ship:	584,105,928
Second Ship:	564,024,944
Third Ship:	552,747,049
Fourth Ship:	544,948,010
Fifth Ship:	539,011,914
Sixth Ship:	534,234,009

### T-AO Cost Analysis

SWBS	Description	Weight	Other	Material CER	Material Cost	Labor CER	Labor Cost
110	SHELL + SUPPORTS	3,759.0		945	3,550,529	269	1,009,671
120	HULL STRUCTURAL BULKHDS	1,788.0		945	1,688,839	269	480,259
130	HULL DECKS	1,789.0		945	1,689,783	269	480,527
140	HULL PLATFORMS/FLATS	372.0		945	351,369	269	99,920
150	DECK HOUSE STRUCTURE	833.0		822	685,059	588	489,804
160	SPECIAL STRUCTURES	304.5		13,052	3,974,334	213	64,859
164	BALLISTIC PLATING	0.0		1,200	0	100	0
170	MASTS+KINGPOSTS+SERV PLATFORM	213.0		4,946	1,053,413	139	29,607
180	FOUNDATIONS	217.0		822	178,461	305	66,185
190	SPECIAL PURPOSE SYSTEMS	431.0		3,806	1,640,558	343	147,833
210	ENERGY GEN SYS (NUCLEAR)						
220	ENERGY GENERATING SYSTEM (NONNUC)						
230	PROPULSION UNITS	443.0	57,750	115	6,612,375	178	78,854
240	TRANSMISSION+PROPULSOR SYSTEMS	235.0	57,750	50	2,887,500	138	44,022
243	SHAFTING	84.0	245	16002	3,924,967		
250	SUPPORT SYSTEMS	125.0	32,500		0	350	43,750
260	PROPUL SUP SYS- FUEL, LUBE OIL	86.0	32,500	29,533	2,539,852	1,200	103,200
290	SPECIAL PURPOSE SYSTEMS	40.0	32,500		0		0
310	ELECTRIC POWER GENERATION	137.0	7,500	650	4,875,000	3	21,733
320	POWER DISTRIBUTION SYS	248.0	3,000,000	73,747	10,636,094	1,100	272,800
330	LIGHTING SYSTEM	59.0		5,450	321,550	1,130	66,670
340	POWER GENERATION SUPPORT SYS	43.0	3,000,000	10,909	1,573,290	1,600	68,800
390	SPECIAL PURPOSE SYS	17.0		788	13,396	400	6,800
410	COMMAND+CONTROL SYS	0.3			0	200	60
420	NAVIGATION SYS	6.8			0	200	1,360
430	INTERIOR COMMUNICATIONS	17.0			0	200	3,400
440	EXTERIOR COMMUNICATIONS	13.0			0	200	2,600
450	SURF SURV SYS (RADAR)	1.2			0	200	240
460	UNDERWATER SURVEILLANCE SYSTEMS				0	200	0
470	COUNTERMEASURES	75.0			0	200	15,000
480	FIRE CONTROL SYS	1.6			0	200	320

490	SPECIAL PURPOSE SYS	4.6		0	200	920
510	CLIMATE CONTROL	227.0	26,294	5,968,738	420	95,340
520	SEA WATER SYSTEMS	257.0	40,564	10,424,948	577	148,289
530	FRESH WATER SYSTEMS	132.0	27,226	3,593,832	450	59,400
540	FUELS/LUBRICANTS,HANDLING+STORAGE	386.0	33,700	13,008,200	230	88,780
550	AIR,GAS+MISC FLUID SYSTEM	255.0	56,212	14,334,060	550	140,250
560	SHIP CNTL SYS	139.0	11,220	1,559,580	300	41,700
570	UNDERWAY REPLENISHMENT SYSTEMS	398.0	6,428	2,558,344	150	59,700
580	MECHANICAL HANDLING SYSTEMS	266.0	13,482	3,586,212	220	58,520
590	SPECIAL PURPOSE SYSTEMS	160.0	1,510	241,600	240	38,400
610	SHIP FITTINGS	24.4	55,033	1,342,805	750	18,300
620	HULL COMPARTMENTATION	455.7	11,160	5,085,612	630	287,091
630	PRESERVATIVES+COVERINGS	356.0	10,789	3,840,884	420	149,520
640	LIVING SPACES	71.0	29,677	2,107,067	1,050	74,550
650	SERVICE SPACES	29.0	26,174	759,046	115	3,335
660	WORKING SPACES	43.0	27,376	1,177,168	248	10,664
670	STOWAGE SPACES	120.0	86,901	10,428,120	10	1,200
690	SPECIAL PURPOSE SYSTEMS	0.4	35,511	14,204	590	236
710	GUNS+AMMUNITION				200	0
720	MISSILES+ROCKETS	17.0			200	3,400
730	MINES				200	0
740	DEPTH CHARGES				200	0
750	TORPEDOES				200	0
760	SMALL ARMS+PYROTECHNICS	0.8			200	160
770	CARGO MUNITIONS				200	0
780	AIRCRAFT RELATED WEAPONS				200	0
790	SPECIAL PURPOSE SYSTEMS	2.1			200	420
F10	SHIPS FORCE	19.0				
F20	MISSION RELATED EXPENDABLES+SYS	7.2				
F30	STORES	61.6				
F40	LIQUIDS, PETROLEUM BASED	1,645.0				
F50	LIQUIDS, NON-PETRO BASED	68.0				

Total 1991 Material Cost:	128,226,790	
Total 1996 Material Cost:	163,653,487	
1996 Cost of 512 VLS Cells:	0	
1996 Cost of Tomahawk Weapon Control Sys:	0	
Total Reference Labor Hours:	9,064,157	'Ship Assembly and Support Labor
Learning Curve Exponent:	95.00%	SASLabor = 0.478 * Labor
Total 1996 Lead Ship Labor Hours:	10,043,387	
Total 1996 Second Ship Labor Hours:	9,541,218	'Integration and Engineering Labor
Total 1996 Third Ship Labor Hours:	9,259,189	IELabor = 0.186 * Labor
Total 1996 Fourth Ship Labor Hours:	9,064,157	
Total 1996 Fifth Ship Labor Hours:	8,915,712	'Program Management Labor
Total 1996 Sixth Ship Labor Hours:	8,796,230	ProgManLabor = 0.194 * Labor
1996 Labor Cost per Hour:	25.0	
Total 1996 Lead Ship Labor Cost:	251,084,681	
Total 1996 Second Ship Labor Cost:	238,530,447	
Total 1996 Third Ship Labor Cost:	231,479,730	
Total 1996 Fourth Ship Labor Cost:	226,603,925	
Total 1996 Fifth Ship Labor Cost:	222,892,795	
Total 1996 Sixth Ship Labor Cost:	219,905,743	
Non-recurring Engineering Hours:	2,000,000	
Engineering Burdened Rate:	45.0	
Non-recurring Engineering Cost:	90,000,000	
Shipyard General & Administrative Overhead:	6.50%	
Shipyard Insurance:	1.00%	
Shipyard Contingency:	10.00%	
Shipyard Profit:	4.00%	

Total Fee + Overhead Rate:	22.98%
Navy Program Cost Factor:	10.00%

Total 1996 Acquisition Costs	
Non-recurring Engineering Cost:	99,000,000
Lead Ship:	561,049,500
Second Ship:	544,066,383
Third Ship:	534,528,314
Fourth Ship:	527,932,422
Fifth Ship:	522,912,080
Sixth Ship:	518,871,256

## BIBLIOGRAPHY

- D-1. Rivera G. and Le T., “*Arsenal Ship Tomahawk Design Options*” NSWC Dahlgren, May, 1996.
- D-2. Herrington, J. B. “Uniform Framework For IMU/GPS Integration Using Kalman Filtering,” Master’s Thesis, Department Of Aeronautics, Naval Post Graduate School, Monterey, CA, June, 1995.
- D-3. Clynych, J., “A Global Positioning System (GPS) Users Seminar,” Department of Oceanography, Naval Post Graduate School, Monterey, CA, March, 1996.
- D-4. Barton, D. K., *MODERN RADAR SYSTEMS*, Artech House, Inc., 1988.
- D-5. Gates, P. J., *SURFACE WARSHIPS Vol. III*, Brassey’s Sea Power: Naval Weapons Systems and Technology Series, Volume 3, 1987
- D-6. Gill, C., “AA4276 Design Project - A Guidance, Navigation, and Control System for the Boeing 747,” Department Of Aeronautics, Naval Post Graduate School, Monterey, CA, December, 1995.
- D-7. Harney, R. C., Class Notes for TS3003, U. S. Naval Post Graduate School, Monterey, CA, 1996
- D-8. White, C. And Reiber, C. “Navy Technical Assessment of LTN-72 Inertial Navigation Software Program 72-9-20,” Technical Report, Naval Air Test Center Patuxent River, Maryland, June 1985